

**ONKYO®**

**AV Receiver**

# ***TX-SR508***

**Instruction Manual**

Thank you for purchasing an Onkyo AV Receiver. Please read this manual thoroughly before making connections and plugging in the unit. Following the instructions in this manual will enable you to obtain optimum performance and listening enjoyment from your new AV Receiver. Please retain this manual for future reference.

## **Contents**

**Introduction .....2**

**Connections..... 11**

**Turning On & Basic Operations .....20**

**Advanced Operations .....34**

**Controlling iPod & Other  
Components.....49**

**Others .....56**

## WARNING:

TO REDUCE THE RISK OF FIRE OR ELECTRIC SHOCK, DO NOT EXPOSE THIS APPARATUS TO RAIN OR MOISTURE.

## CAUTION:

TO REDUCE THE RISK OF ELECTRIC SHOCK, DO NOT REMOVE COVER (OR BACK). NO USER-SERVICEABLE PARTS INSIDE. REFER SERVICING TO QUALIFIED SERVICE PERSONNEL.



**WARNING**  
RISK OF ELECTRIC SHOCK  
DO NOT OPEN

**AVIS**  
RISQUE DE CHOC ELECTRIQUE  
NE PAS OUVRIR



The lightning flash with arrowhead symbol, within an equilateral triangle, is intended to alert the user to the presence of uninsulated “dangerous voltage” within the product’s enclosure that may be of sufficient magnitude to constitute a risk of electric shock to persons.



The exclamation point within an equilateral triangle is intended to alert the user to the presence of important operating and maintenance (servicing) instructions in the literature accompanying the appliance.

## Important Safety Instructions

1. Read these instructions.
2. Keep these instructions.
3. Heed all warnings.
4. Follow all instructions.
5. Do not use this apparatus near water.
6. Clean only with dry cloth.
7. Do not block any ventilation openings. Install in accordance with the manufacturer’s instructions.
8. Do not install near any heat sources such as radiators, heat registers, stoves, or other apparatus (including amplifiers) that produce heat.
9. Do not defeat the safety purpose of the polarized or grounding-type plug. A polarized plug has two blades with one wider than the other. A grounding type plug has two blades and a third grounding prong. The wide blade or the third prong are provided for your safety. If the provided plug does not fit into your outlet, consult an electrician for replacement of the obsolete outlet.
10. Protect the power cord from being walked on or pinched particularly at plugs, convenience receptacles, and the point where they exit from the apparatus.
11. Only use attachments/accessories specified by the manufacturer.
12. Use only with the cart, stand, tripod, bracket, or table specified by the manufacturer, or sold with the apparatus. When a cart is used, use caution when moving the cart/apparatus combination to avoid injury from tip-over.  

PORTABLE CART WARNING  
S3125A
13. Unplug this apparatus during lightning storms or when unused for long periods of time.
14. Refer all servicing to qualified service personnel. Servicing is required when the apparatus has been damaged in any way, such as power-supply cord or plug is damaged, liquid has been spilled or objects have fallen into the apparatus, the apparatus has been exposed to rain or moisture, does not operate normally, or has been dropped.
15. Damage Requiring Service  
Unplug the apparatus from the wall outlet and refer servicing to qualified service personnel under the following conditions:
  - A. When the power-supply cord or plug is damaged,
  - B. If liquid has been spilled, or objects have fallen into the apparatus,
  - C. If the apparatus has been exposed to rain or water,
  - D. If the apparatus does not operate normally by following the operating instructions. Adjust only those controls that are covered by the operating instructions as an improper adjustment of other controls may result in damage and will often require extensive work by a qualified technician to restore the apparatus to its normal operation,
  - E. If the apparatus has been dropped or damaged in any way, and
  - F. When the apparatus exhibits a distinct change in performance this indicates a need for service.
16. Object and Liquid Entry  
Never push objects of any kind into the apparatus through openings as they may touch dangerous voltage points or short-out parts that could result in a fire or electric shock.  
The apparatus shall not be exposed to dripping or splashing and no objects filled with liquids, such as vases shall be placed on the apparatus.  
Don’t put candles or other burning objects on top of this unit.
17. Batteries  
Always consider the environmental issues and follow local regulations when disposing of batteries.
18. If you install the apparatus in a built-in installation, such as a bookcase or rack, ensure that there is adequate ventilation.  
Leave 20 cm (8") of free space at the top and sides and 10 cm (4") at the rear. The rear edge of the shelf or board above the apparatus shall be set 10 cm (4") away from the rear panel or wall, creating a flue-like gap for warm air to escape.

# Precautions

---

1. **Recording Copyright**—Unless it's for personal use only, recording copyrighted material is illegal without the permission of the copyright holder.
2. **AC Fuse**—The AC fuse inside the unit is not user-serviceable. If you cannot turn on the unit, contact your Onkyo dealer.
3. **Care**—Occasionally you should dust the unit all over with a soft cloth. For stubborn stains, use a soft cloth dampened with a weak solution of mild detergent and water. Dry the unit immediately afterwards with a clean cloth. Don't use abrasive cloths, thinners, alcohol, or other chemical solvents, because they may damage the finish or remove the panel lettering.

## 4. Power

### WARNING

BEFORE PLUGGING IN THE UNIT FOR THE FIRST TIME, READ THE FOLLOWING SECTION CAREFULLY.

AC outlet voltages vary from country to country. Make sure that the voltage in your area meets the voltage requirements printed on the unit's rear panel (e.g., AC 230 V, 50 Hz or AC 120 V, 60 Hz).

The power cord plug is used to disconnect this unit from the AC power source. Make sure that the plug is readily operable (easily accessible) at all times.

Pressing **ON/STANDBY** to select Standby mode does not fully shutdown the unit. If you do not intend to use the unit for an extended period, remove the power cord from the AC outlet.

## 5. Preventing Hearing Loss

### Caution

Excessive sound pressure from earphones and headphones can cause hearing loss.

## 6. Batteries and Heat Exposure

### Warning

Batteries (battery pack or batteries installed) shall not be exposed to excessive heat as sunshine, fire or the like.

7. **Never Touch this Unit with Wet Hands**—Never handle this unit or its power cord while your hands are wet or damp. If water or any other liquid gets inside this unit, have it checked by your Onkyo dealer.

## 8. Handling Notes

- If you need to transport this unit, use the original packaging to pack it how it was when you originally bought it.
- Do not leave rubber or plastic items on this unit for a long time, because they may leave marks on the case.
- This unit's top and rear panels may get warm after prolonged use. This is normal.
- If you do not use this unit for a long time, it may not work properly the next time you turn it on, so be sure to use it occasionally.

## For U.S. models

### FCC Information for User

#### CAUTION:

The user changes or modifications not expressly approved by the party responsible for compliance could void the user's authority to operate the equipment.

#### NOTE:

This equipment has been tested and found to comply with the limits for a Class B digital device, pursuant to Part 15 of the FCC Rules. These limits are designed to provide reasonable protection against harmful interference in a residential installation.

This equipment generates, uses and can radiate radio frequency energy and, if not installed and used in accordance with the instructions, may cause harmful interference to radio communications. However, there is no guarantee that interference will not occur in a particular installation. If this equipment does cause harmful interference to radio or television reception, which can be determined by turning the equipment off and on, the user is encouraged to try to correct the interference by one or more of the following measures:

- Reorient or relocate the receiving antenna.
- Increase the separation between the equipment and receiver.
- Connect the equipment into an outlet on a circuit different from that to which the receiver is connected.
- Consult the dealer or an experienced radio/TV technician for help.

## For Canadian Models

**NOTE:** THIS CLASS B DIGITAL APPARATUS COMPLIES WITH CANADIAN ICES-003.

For models having a power cord with a polarized plug:

**CAUTION:** TO PREVENT ELECTRIC SHOCK, MATCH WIDE BLADE OF PLUG TO WIDE SLOT, FULLY INSERT.

## Modèle pour les Canadien

**REMARQUE:** CET APPAREIL NUMÉRIQUE DE LA CLASSE B EST CONFORME À LA NORME NMB-003 DU CANADA.

Sur les modèles dont la fiche est polarisée:

**ATTENTION:** POUR ÉVITER LES CHOCS ÉLECTRIQUES, INTRODUIRE LA LAME LA PLUS LARGE DE LA FICHE DANS LA BORNE CORRESPONDANTE DE LA PRISE ET POUSSER JUSQU'AU FOND.

## For British models

Replacement and mounting of an AC plug on the power supply cord of this unit should be performed only by qualified service personnel.

### IMPORTANT

The wires in the mains lead are coloured in accordance with the following code:

Blue: Neutral

Brown: Live

As the colours of the wires in the mains lead of this apparatus may not correspond with the coloured markings identifying the terminals in your plug, proceed as follows: The wire which is coloured blue must be connected to the terminal which is marked with the letter N or coloured black.

The wire which is coloured brown must be connected to the terminal which is marked with the letter L or coloured red.

### IMPORTANT

The plug is fitted with an appropriate fuse. If the fuse needs to be replaced, the replacement fuse must be approved by ASTA or BSI to BS1362 and have the same ampere rating as that indicated on the plug. Check for the ASTA mark or the BSI mark on the body of the fuse.

If the power cord's plug is not suitable for your socket outlets, cut it off and fit a suitable plug. Fit a suitable fuse in the plug.

## For European Models

### Declaration of Conformity

We, ONKYO EUROPE  
ELECTRONICS GmbH  
LIEGNITZERSTRASSE 6,  
82194 GROEBENZELL,  
GERMANY



declare in own responsibility, that the ONKYO product described in this instruction manual is in compliance with the corresponding technical standards such as EN60065, EN55013, EN55020 and EN61000-3-2, -3-3.

GROEBENZELL, GERMANY

K. MIYAGI

ONKYO EUROPE ELECTRONICS GmbH

# Supplied Accessories

Make sure you have the following accessories:

Indoor FM antenna (→ 18)

AM loop antenna (→ 18)

Speaker cable labels (→ 11)

Speaker setup microphone (→ 23)

Remote controller and two batteries (AA/R6) (→ 4)

(Note for China: The battery for the remote controller is not supplied for this unit.)

- \* In catalogs and on packaging, the letter at the end of the product name indicates the color. Specifications and operations are the same regardless of color.

## Using the Remote Controller

### Installing the Batteries

#### Note

- If the remote controller doesn't work reliably, try replacing the batteries.
- Don't mix new and old batteries or different types of batteries.
- If you intend not to use the remote controller for a long time, remove the batteries to prevent damage from leakage or corrosion.
- Remove expired batteries as soon as possible to prevent damage from leakage or corrosion.

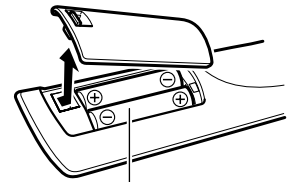

Batteries (AA/R6)

### Aiming the Remote Controller

To use the remote controller, point it at the AV receiver's remote control sensor, as shown below.

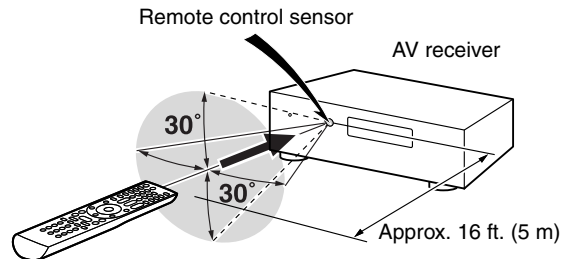

# Contents

<b>Introduction</b>	
<b>Important Safety Instructions</b> .....	<b>2</b>
<b>Precautions</b> .....	<b>3</b>
<b>Supplied Accessories</b> .....	<b>4</b>
Using the Remote Controller .....	4
<b>Features</b> .....	<b>6</b>
<b>Front &amp; Rear Panels</b> .....	<b>7</b>
Front Panel.....	7
Display.....	8
Rear Panel .....	8
<b>Remote Controller</b> .....	<b>9</b>
Controlling the AV Receiver .....	9
<b>About Home Theater</b> .....	<b>10</b>
Enjoying Home Theater.....	10

<b>Connections</b>	
<b>Connecting the AV Receiver</b> .....	<b>11</b>
Connecting Your Speakers .....	11
About AV Connections .....	14
Connecting Components with HDMI .....	15
Connecting External Components.....	16
Using the AUX INPUT jacks on the front panel.....	17
Connecting Onkyo <b>RI</b> Components .....	17
Connecting Antenna.....	18
Which Connections Should I Use? .....	19

<b>Turning On &amp; Basic Operations</b>	
<b>Turning On/Off the AV Receiver</b> .....	<b>20</b>
Turning On .....	20
Turning Off .....	20
<b>Basic Operations</b> .....	<b>21</b>
Playing the Connected Component.....	21
Displaying Source Information .....	21
Using the Music Optimizer .....	21
Setting the Display Brightness .....	21
Muting the AV Receiver.....	22
Using the Sleep Timer.....	22
Using Headphones.....	22
Changing the Input Display .....	22
Selecting Speaker Layout .....	22
Audyssey 2EQ® Room Correction and Speaker Setup .....	23
<b>Listening to the Radio</b> .....	<b>25</b>
Using the Tuner.....	25
Presetting FM/AM Stations.....	26
Using RDS (excluding North American models) .....	26
<b>Recording</b> .....	<b>28</b>
<b>Using the Listening Modes</b> .....	<b>29</b>
Selecting Listening Modes .....	29
About Listening Modes.....	30

<b>Advanced Operations</b>	
<b>Advanced Setup</b> .....	<b>34</b>
On-screen Setup Menus.....	34
Common Procedures in Setup Menu .....	34
HDMI Input .....	35
Component (Component Video Input).....	35
Digital Audio (Digital Audio Input).....	35
Sp Config (Speaker Configuration).....	36
Sp Distance (Speaker Distance) .....	37
Level Cal (Level Calibration) .....	37
Audio Adjust .....	37
Name Edit.....	40
Hardware .....	40
HDMI Setup .....	41
Using the Audio Settings .....	43
Digital Input Signal Formats .....	45
Adjusting the Bass & Treble .....	45
<b>Zone 2</b> .....	<b>46</b>
Connecting Zone 2 .....	46
Setting the Powered Zone 2 .....	47
Using Zone 2 .....	47

<b>Controlling iPod &amp; Other Components</b>	
<b>Controlling iPod</b> .....	<b>49</b>
Connecting an Onkyo Dock.....	49
Using the Onkyo Dock.....	50
Controlling Your iPod.....	51
<b>Controlling Other Components</b> .....	<b>53</b>
Preprogrammed Remote Control Codes .....	53
Entering Remote Control Codes.....	53
Remote Control Codes for Onkyo Components Connected via <b>RI</b> .....	53
Resetting REMOTE MODE Buttons .....	54
Resetting the Remote Controller .....	54
Controlling Other Components .....	54

<b>Others</b>	
<b>Troubleshooting</b> .....	<b>56</b>
<b>Specifications</b> .....	<b>60</b>
<b>About HDMI</b> .....	<b>61</b>
<b>Using an RIHD-compatible TV, Player, or Recorder</b> ...	<b>62</b>

**To reset the AV receiver to its factory defaults, turn it on and, while holding down VCR/DVR, press ON/STANDBY (→ 56).**

# Features

## Amplifier

- 90 Watts/Channel @ 8 ohms (FTC)
- 130 Watts/Channel @ 6 ohms (IEC)
- 160 Watts/Channel @ 6 ohms (JEITA)
- WRAT—Wide Range Amplifier Technology (5 Hz to 100 kHz bandwidth)
- Optimum Gain Volume Circuitry
- H.C.P.S. (High Current Power Supply) Massive High Power Transformer

## Processing

- HDMI (Ver.1.4 with Audio Return Channel, 3D), Deep-Color, x.v.Color\*, Lip Sync, DTS\*1-HD Master Audio, DTS-HD High Resolution Audio, Dolby TrueHD\*2, Dolby Digital Plus, DSD and Multi-CH PCM
- Dolby Pro Logic IIz\*2 (with “Front High” Direction Mode)
- Non-Scaling Configuration
- A-Form Listening Mode Memory
- Direct Mode
- Pure Audio Mode (**European and Asian models**)
- Music Optimizer\*3 for Compressed Digital Music files
- 192 kHz/24-bit D/A Converters
- Powerful and Highly Accurate 32-bit Processing DSP

## Connections

- 4 HDMI\*4 Inputs and 1 Output
- Onkyo **RIHD** for System Control
- 4 Digital Inputs (2 Optical/2 Coaxial)
- Component Video Switching (2 Inputs/1 Output)
- Universal Port for the Dock for iPod\*/HD Radio™\*5 tuner module (**North American models**)/DAB+ tuner module (**European and Asian models**)
- Front “Line in” Input for Portable audio player
- Banana Plug-Compatible Speaker Posts\*6
- Powered Zone 2
- Bi-Amping Capability for FL/FR with SBL/SBR

## Miscellaneous

- 40 SIRIUS\*7/FM/AM Presets (**North American models**)
- 40 FM/AM Presets (**European and Asian models**)
- Audyssey 2EQ\*8 to Correct Room Acoustic Problems
- Audyssey Dynamic EQ™\*8 for Loudness Correction
- Audyssey Dynamic Volume™\*8 to Maintain Optimal Listening Level and Dynamic Range
- Crossover Adjustment (40/50/60/80/100/120/150/200 Hz)
- A/V Sync Control Function (up to 100 ms)
- On-Screen Display via HDMI
- Preprogrammed **RI**-Compatible Remote

### \*1 DTS-HD Master Audio

Manufactured under license under U.S. Patent #'s: 5,451,942; 5,956,674; 5,974,380; 5,978,762; 6,226,616; 6,487,535; 7,212,872; 7,333,929; 7,392,195; 7,272,567 & other U.S. and worldwide patents issued & pending. DTS is a registered trademark and the DTS logos, Symbol, DTS-HD and DTS-HD Master Audio are trademarks of DTS, Inc. ©1996-2008 DTS, Inc. All Rights Reserved.

### \*2 DOLBY TRUEHD PRO LOGIC IIz

Manufactured under license from Dolby Laboratories. “Dolby”, “Pro Logic” and the double-D symbol are trademarks of Dolby Laboratories.

\*3 Music Optimizer™ is a trademark of Onkyo Corporation.

### \*4 HDMI

“HDMI, the HDMI Logo, and High-Definition Multimedia Interface are trademarks or registered trademarks of HDMI Licensing LLC in the United States and other countries.”

### \*5 HD Radio READY

The HD Radio Ready logo is a proprietary trademark of iBiquity Digital Corp.

To receive HD Radio broadcasts, you must install an Onkyo UP-HT1 HD Radio tuner module (sold separately).

\*6 In Europe, using banana plugs to connect speakers to an audio amplifier is prohibited.

### \*7 SIRIUS READY

SIRIUS, XM and all related marks and logos are trademarks of Sirius XM Radio Inc. and its subsidiaries. All other marks and logos are the property of their respective owners. All rights reserved. SIRIUS subscription sold separately. Taxes and a one-time activation fee may apply. SIRIUS tuner required (sold separately) to receive the SIRIUS service. All programming and fees subject to change. It is prohibited to copy, decompile, disassemble, reverse engineer, hack, manipulate or otherwise make available any technology or software incorporated in receivers compatible with the SIRIUS Satellite Radio System. Service not available in Alaska or Hawaii.

### \*8 AUDYSSEY 2EQ DYNAMIC VOLUME

Manufactured under license from Audyssey Laboratories™. U.S. and foreign patents pending. Audyssey 2EQ®, Audyssey Dynamic Volume™ and Audyssey Dynamic EQ™ are trademarks of Audyssey Laboratories.

\* Apple and iPod are trademarks of Apple Inc., registered in the U.S. and other countries.

\* “x.v.Color” is a trademark of Sony Corporation.

# Front & Rear Panels

## Front Panel

### North American models

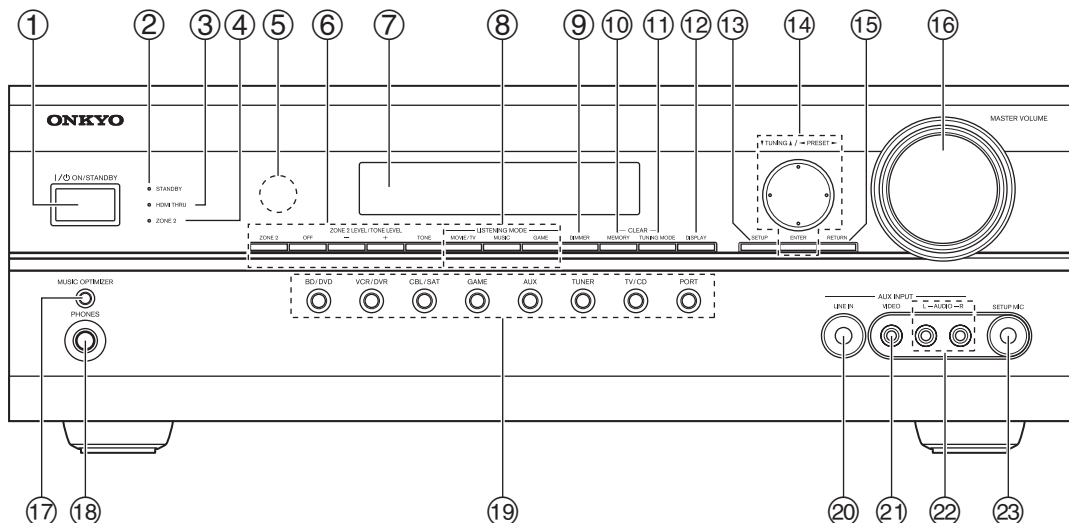

### European and Asian models

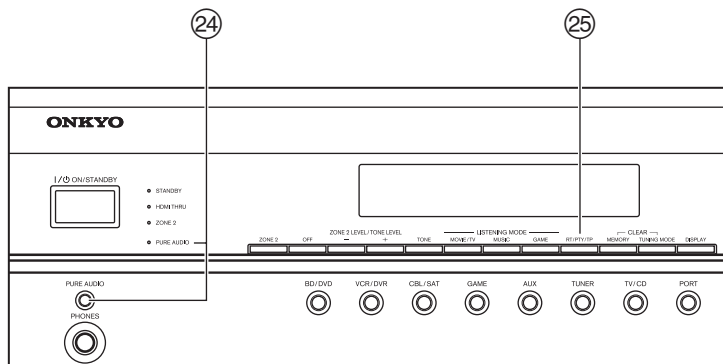

The actual front panel has various logos printed on it. They are not shown here for clarity.

The page numbers in parentheses show where you can find the main explanation for each item.

- ① **ON/STANDBY** button (→ 20)
- ② **STANDBY** indicator (→ 20)
- ③ **HDMI THRU** indicator (→ 42)
- ④ **ZONE 2** indicator (→ 47)
- ⑤ **Remote control sensor** (→ 4)
- ⑥ **ZONE 2, OFF, ZONE 2 LEVEL/TONE LEVEL and TONE** buttons (→ 45, 47 to 48)
- ⑦ **Display** (→ 8)
- ⑧ **LISTENING MODE** buttons (→ 29)
- ⑨ **DIMMER** button (North American models) (→ 21)
- ⑩ **MEMORY** button (→ 26)
- ⑪ **TUNING MODE** button (→ 25)
- ⑫ **DISPLAY** button (→ 21)
- ⑬ **SETUP** button (→ 34)
- ⑭ **TUNING, PRESET** (→ 25 to 26), **arrow and ENTER** buttons
- ⑮ **RETURN** button
- ⑯ **MASTER VOLUME** control (→ 21)
- ⑰ **MUSIC OPTIMIZER** button (North American models) (→ 21, 43)
- ⑱ **PHONES** jack (→ 22)
- ⑲ **Input selector buttons** (→ 21)
- ⑳ **AUX INPUT LINE IN** jack (→ 17)
- ㉑ **AUX INPUT VIDEO** jack (→ 17)
- ㉒ **AUX INPUT AUDIO** jacks (→ 17)
- ㉓ **SETUP MIC** jack (→ 23)
- ㉔ **PURE AUDIO** button and indicator (European and Asian models) (→ 29)
- ㉕ **RT/PTY/TP** button (European and Asian models) (→ 26)

## Display

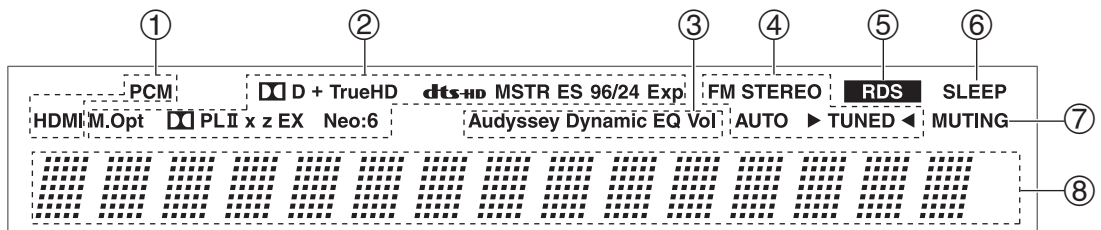

For detailed information, see the pages in parentheses.

- ① **Audio input indicators**
- ② **Listening mode and format indicators (→ 21, 29)**
- ③ **Audyssey indicators (→ 23, 38)**
- ④ **Tuning indicators (→ 25)**
- ⑤ **RDS indicator (excluding North American models) (→ 26)**
- ⑥ **SLEEP indicator (→ 22)**
- ⑦ **MUTING indicator (→ 22)**
- ⑧ **Message area**

## Rear Panel

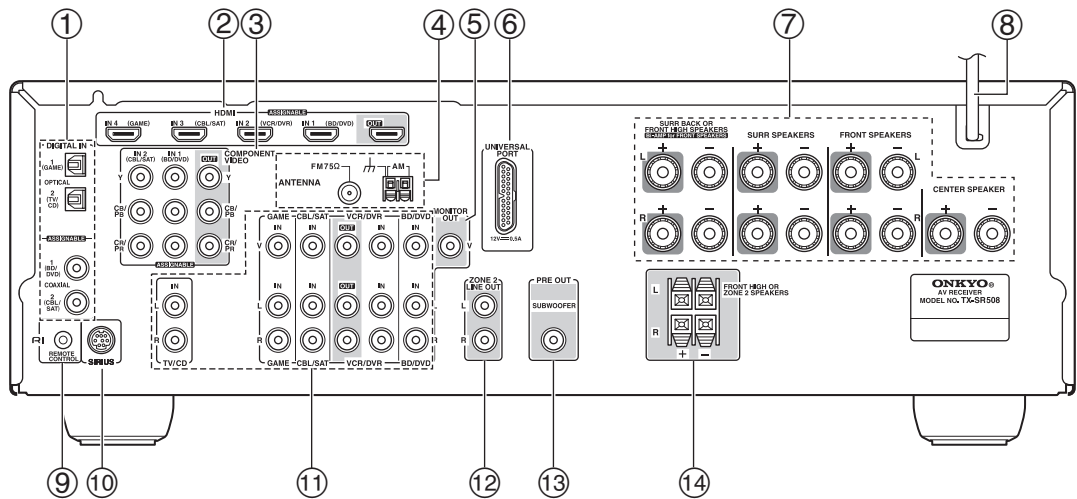

- ① **DIGITAL IN COAXIAL and OPTICAL jacks**
- ② **HDMI IN and OUT jacks**
- ③ **COMPONENT VIDEO IN and OUT jacks**
- ④ **FM ANTENNA jack and AM ANTENNA terminal**
- ⑤ **MONITOR OUT V jack**
- ⑥ **UNIVERSAL PORT jack**
- ⑦ **SPEAKERS terminals (CENTER, FRONT, SURR, SURR BACK OR FRONT HIGH)**
- ⑧ **Power cord**
- ⑨ **RI REMOTE CONTROL jack**
- ⑩ **SIRIUS antenna jack (North American models)**
- ⑪ **Composite video and analog audio jacks (BD/DVD IN, VCR/DVR IN and OUT, CBL/SAT IN, GAME IN, TV/CD IN)**
- ⑫ **ZONE 2 LINE OUT jacks**
- ⑬ **SUBWOOFER PRE OUT jack**
- ⑭ **FRONT HIGH OR ZONE 2 SPEAKERS terminals**

See “Connecting the AV Receiver” for connection information (→ 11 to 19).



# Remote Controller

## Controlling the AV Receiver

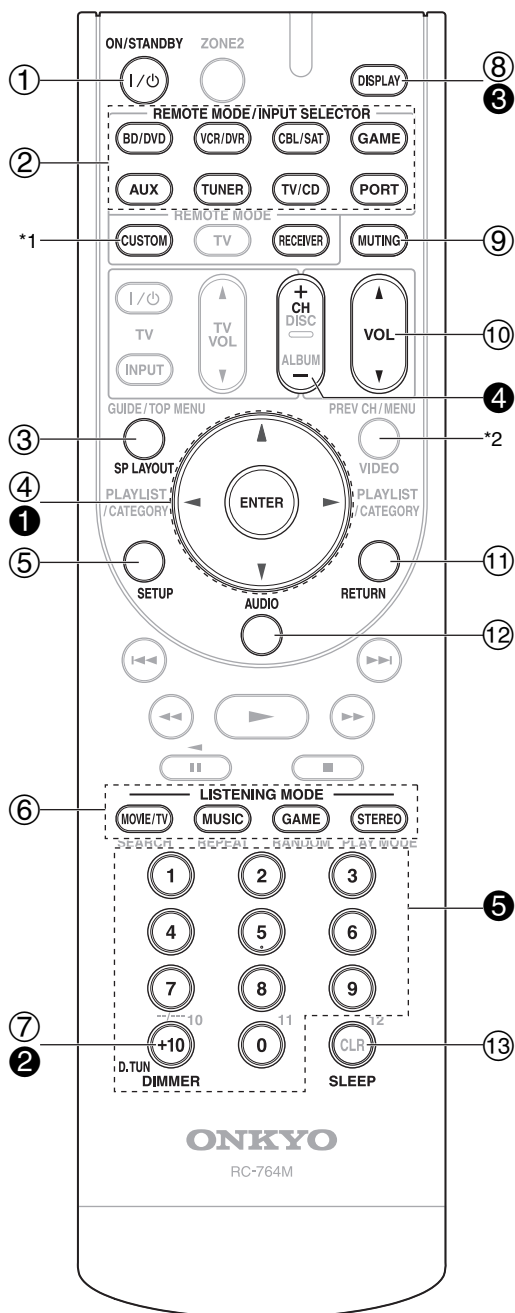

To control the AV receiver, press **RECEIVER** to select Receiver mode.

You can also use the remote controller to control Onkyo Blu-ray Disc/DVD player, CD player, and other components.

See “Entering Remote Control Codes” for more details (→ 53).

For detailed information, see the pages in parentheses.

- ① **ON/STANDBY** button (→ 20)
- ② **REMOTE MODE/INPUT SELECTOR** buttons (→ 21)
- ③ **SP LAYOUT** button (→ 22)
- ④ **Arrow ▲/▼/◀/▶ and ENTER** buttons
- ⑤ **SETUP** button (→ 34)
- ⑥ **LISTENING MODE** buttons (→ 29)
- ⑦ **DIMMER** button (→ 21)
- ⑧ **DISPLAY** button (→ 21)
- ⑨ **MUTING** button (→ 22)
- ⑩ **VOL ▲/▼** button (→ 21)
- ⑪ **RETURN** button
- ⑫ **AUDIO** button (→ 43)
- ⑬ **SLEEP** button (→ 22)

### ■ Controlling the tuner

To control the AV receiver’s tuner, press **TUNER** (or **RECEIVER**).

You can select AM or FM by pressing **TUNER** repeatedly.

- ① **Arrow ▲/▼** buttons (→ 25)
- ② **D.TUN** button (→ 25)
- ③ **DISPLAY** button
- ④ **CH +/-** button (→ 26)
- ⑤ **Number** buttons (→ 25)

\*1 To control component, you must first enter remote control code.

See “Entering Remote Control Codes” for more details (→ 53).

\*2 **VIDEO** is not used for this model.

# About Home Theater

## Enjoying Home Theater

Thanks to the AV receiver's superb capabilities, you can enjoy surround sound with a real sense of movement in your own home—just like being in a movie theater or concert hall. With Blu-ray Discs, you can enjoy DTS and Dolby Digital. With analog or digital TV, you can enjoy Dolby Pro Logic IIx, DTS Neo:6, or Onkyo's original DSP listening modes.

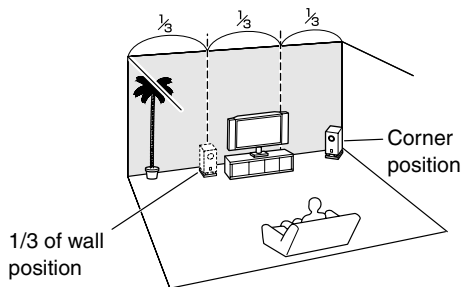
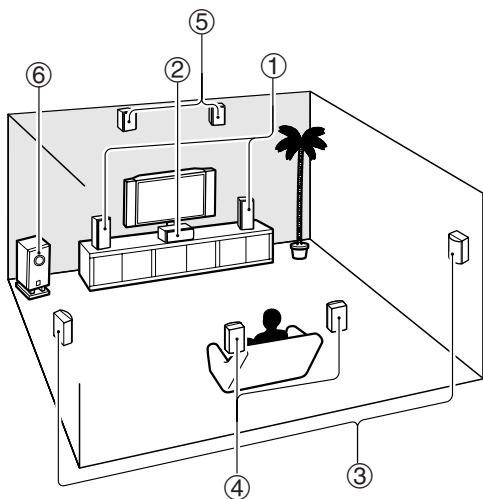

### Tip

- To find the best position for your subwoofer, while playing a movie or some music with good bass, experiment by placing your subwoofer at various positions within the room, and choose the one that provides the most satisfying results.

### ① Front speakers

These output the overall sound. Their role in a home theater is to provide a solid anchor for the sound image. They should be positioned facing the listener at about ear level, and equidistant from the TV. Angle them inward so as to create a triangle, with the listener at the apex.

### ② Center speaker

This speaker enhances the front speakers, making sound movements distinct and providing a full sound image. In movies it's used mainly for dialog. Position it close to your TV facing forward at about ear level, or at the same height as the front speakers.

### ③ Surround speakers

These speakers are used for precise sound positioning and to add realistic ambience. Position them at the sides of the listener, or slightly behind, about 2 to 3 feet (60 to 100 cm) above ear level. Ideally they should be equidistant from the listener.

### ④ Surround back speakers

These speakers are necessary to enjoy Dolby Digital EX, DTS-ES Matrix, DTS-ES Discrete, etc. They enhance the realism of surround sound and improve sound localization behind the listener. Position them behind the listener about 2 to 3 feet (60 to 100 cm) above ear level.

### ⑤ Front high speakers

These speakers are necessary to enjoy Dolby Pro Logic IIz Height, etc. They enhance significantly the spatial experience. Position them at least 3.3 feet (100 cm) above the front speakers (and as high as possible). Although it is acceptable to left and right place at an angle slightly wider than the front speakers. Ideally they should be positioned directly above the front speakers.

### ⑥ Subwoofer

The subwoofer handles the bass sounds of the LFE (Low-Frequency Effects) channel. The volume and quality of the bass output from your subwoofer will depend on its position, the shape of your listening room, and your listening position. In general, a good bass sound can be obtained by installing the subwoofer in a front corner, or at one-third the width of the wall, as shown.

# Connecting the AV Receiver

## Connecting Your Speakers

### Speaker Configuration

The following table indicates the channels you should use depending on the number of speakers that you have.

For 7.1-channel surround-sound playback, you need seven speakers and a powered subwoofer.

Number of channels	2	3	4	5	6	7	7	8	9
Front speakers	✓	✓	✓	✓	✓	✓	✓	✓	✓
Center speaker		✓		✓	✓	✓	✓	✓	✓
Surround speakers			✓	✓	✓	✓	✓	✓	✓
Surround back speaker*1*2					✓			✓	
Surround back speakers*2						✓			✓
Front high speakers*2							✓	✓	✓

\*1 If you're using only one surround back speaker, connect it to the **SURR BACK OR FRONT HIGH L** terminals.

\*2 Front high and surround back speakers cannot be used at the same time.

If you use 4 or 5 speakers, connect each of the two surround speakers to the **SURR L/R** terminals. Do not connect them to the **SURR BACK OR FRONT HIGH L/R** or **FRONT HIGH OR ZONE 2 L/R** terminals.

No matter how many speakers you use, a powered subwoofer is recommended for a really powerful and solid bass.

To get the best from your surround sound system, you need to set the speaker settings. You can do this automatically (→ 23) or manually (→ 36).

### Attaching the Speaker Cable Labels

The AV receiver's positive (+) speaker terminals are all red. (The negative (-) speaker terminals are all black.)

Speaker	Color
Front left, Zone 2 left, Front high left	White
Front right, Zone 2 right, Front high right	Red
Center	Green
Surround left	Blue
Surround right	Gray
Surround back left	Brown
Surround back right	Tan

The supplied speaker cable labels are also color-coded and you should attach them to the positive (+) side of each speaker cable in accordance with the table above. Then all you need to do is to match the color of each label to the corresponding speaker terminal.



### Speaker Connection Precautions

Read the following before connecting your speakers:

- **(North American models)** You can connect speakers with an impedance of between 6 and 16 ohms. If you use speakers with a lower impedance, and use the amplifier at high volume levels for a long period of time, the built-in amp protection circuit may be activated.
- **(European and Asian models)** You can connect speakers with an impedance of between 4 and 16 ohms. If the impedance of any of the connected speakers is 4 ohms or more, but less than 6 ohms, be sure to set the minimum speaker impedance to "4ohms" (→ 40). If you use speakers with a lower impedance, and use the amplifier at high volume levels for a long period of time, the built-in protection circuit may be activated.
- Disconnect the power cord from the wall outlet before making any connections.
- Read the instructions supplied with your speakers.
- Pay close attention to speaker wiring polarity. In other words, connect positive (+) terminals only to positive (+) terminals, and negative (-) terminals only to negative (-) terminals. If you get them the wrong way around, the sound will be out of phase and will sound unnatural.
- Unnecessarily long, or very thin speaker cables may affect the sound quality and should be avoided.
- Be careful not to short the positive and negative wires. Doing so may damage the AV receiver.
- Make sure the metal core of the wire does not have contact with the AV receiver's rear panel. Doing so may damage the AV receiver.

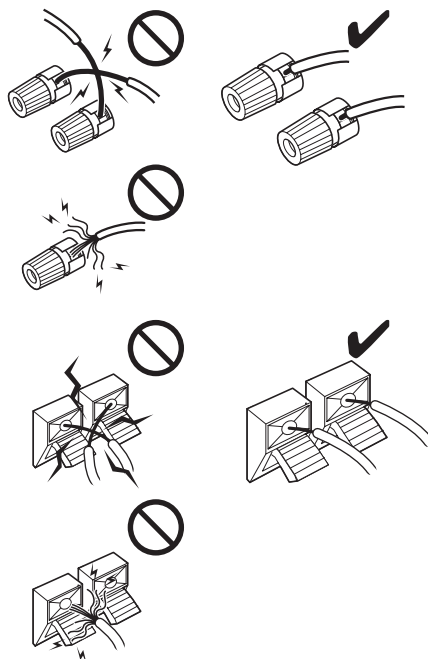

- Don't connect more than one cable to each speaker terminal. Doing so may damage the AV receiver.
- Don't connect one speaker to several terminals.

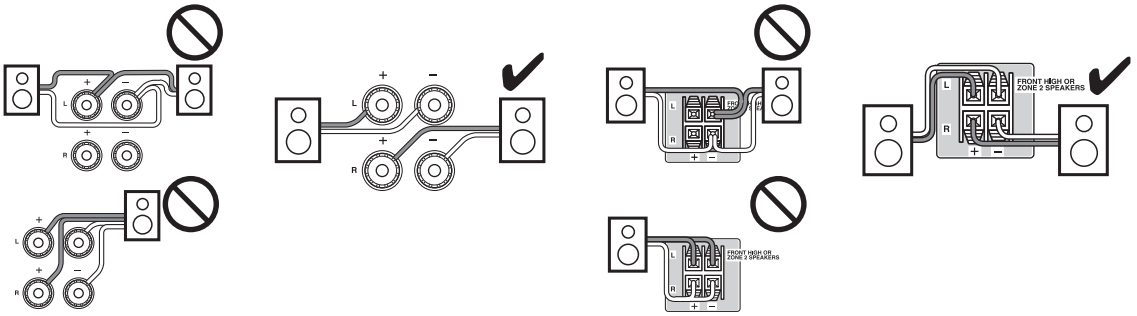

## Connecting the Speaker Cables

### Screw-type speaker terminals

Strip 1/2" to 5/8" (12 to 15 mm) of insulation from the ends of the speaker cables, and twist the bare wires tightly, as shown.

1/2" to 5/8" (12 to 15 mm)

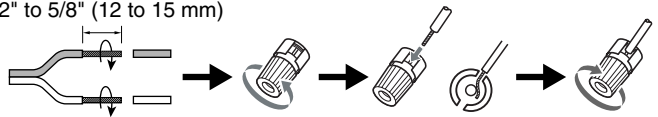

### Using Banana Plugs (North American models)

- If you are using banana plugs, tighten the speaker terminal before inserting the banana plug.
- Do not insert the speaker code directly into the center hole of the speaker terminal.

### Push-type speaker terminals

Strip 3/8" to 1/2" (10 to 12 mm) of insulation from the ends of the speaker cables, and twist the bare wires tightly, as shown.

3/8" to 1/2" (10 to 12 mm)

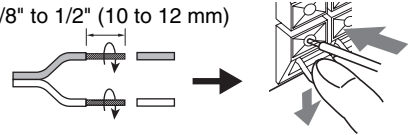

The following illustration shows which speaker should be connected to each pair of terminals. If you're using only one surround back speaker, connect it to the **SURR BACK OR FRONT HIGH L** terminals.

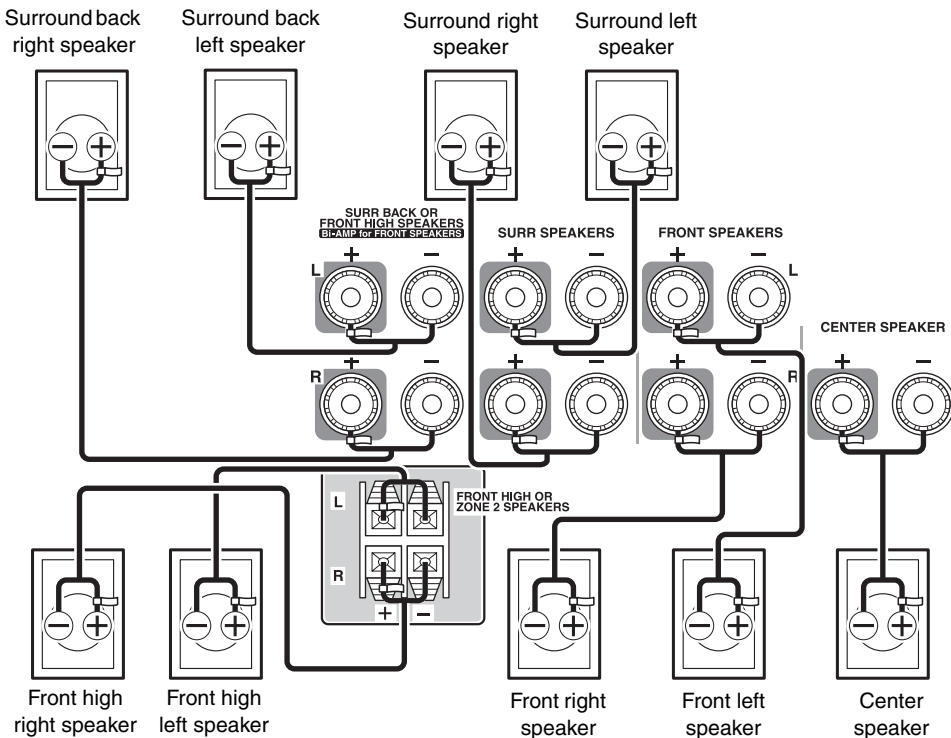

## Connecting a Powered Subwoofer

Using a suitable cable, connect the AV receiver's **SUBWOOFER PRE OUT** jack to an input on your powered subwoofer, as shown. If your subwoofer is unpowered and you're using an external amplifier, connect the **SUBWOOFER PRE OUT** jack to an input on the amp.

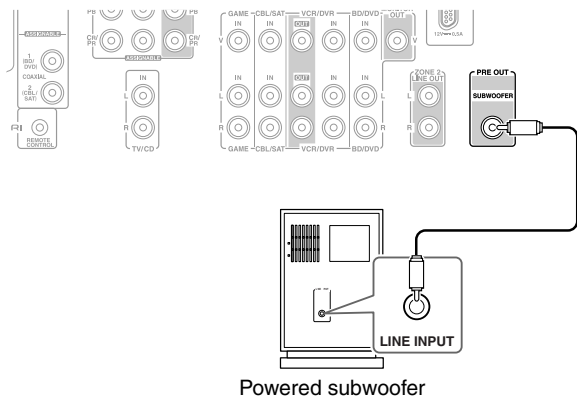

## Bi-amping the Front Speakers

The **FRONT L/R** and **SURR BACK OR FRONT HIGH L/R** terminal posts can be used with front speakers and surround back speakers respectively, or bi-amped to provide separate tweeter and woofer feeds for a pair of front speakers that support bi-amping, providing improved bass and treble performance.

- When bi-amping is used, the AV receiver is able to drive up to a 5.1 speaker system in the main room.
- For bi-amping, the **FRONT L/R** terminal posts connect to the front speakers' woofer terminals; the **SURR BACK OR FRONT HIGH L/R** terminal posts connect to the front speakers' tweeter terminals.
- Once you've completed the bi-amping connections shown below and turned on the AV receiver, you must set the "Speakers Type" setting to "Bi-AMP" to enable bi-amping (→ 40).

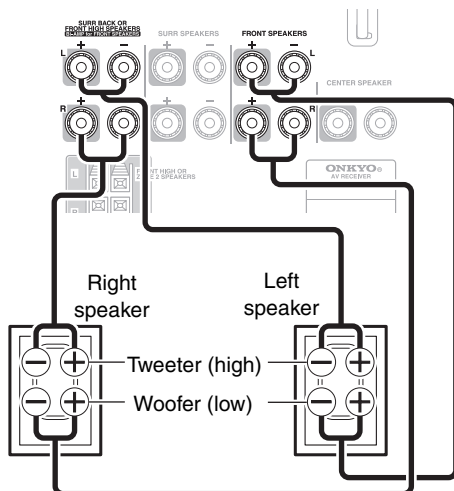

### Important:

- When making the bi-amping connections, be sure to remove the jumper bars that link the speakers' tweeter (high) and woofer (low) terminals.
- Bi-amping can be used only with speakers that support bi-amping. Refer to your speaker manual.



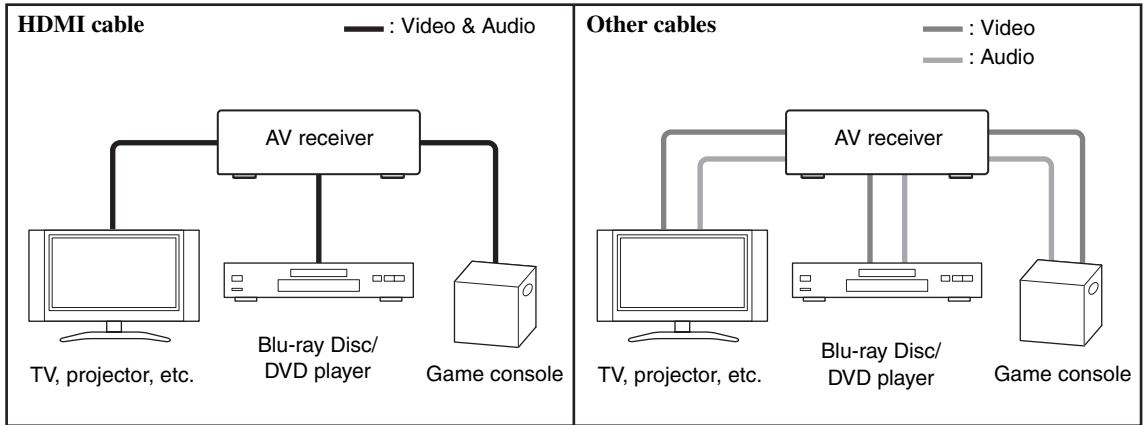



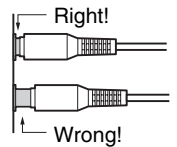



## Connected image with AV components

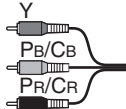

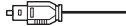
- Before making any AV connections, read the manuals supplied with your AV components.
- Don't connect the power cord until you've completed and double-checked all AV connections.
- Push plugs in all the way to make good connections (loose connections can cause noise or malfunctions).
- To prevent interference, keep audio and video cables away from power cords and speaker cables.

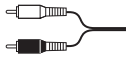

## AV Cables and Jacks

Signal	Cable	Jack	Description	
Video and Audio	HDMI	 	HDMI connections can carry digital video and audio. The AV receiver is compliant with HDMI.	
Video	Component video	 Y PB/CB PR/CR	Y Green PB/PR Blue CB/CR Red	Component video separates the luminance (Y) and color difference signals (PB/CB, PR/CR), providing the best picture quality (some TV manufacturers label their component video sockets slightly differently).
	Composite video	 V	Yellow	Composite video is commonly used on TVs, VCRs, and other video equipment.
Audio	Optical digital audio	 	OPTICAL	Optical digital connections allow you to enjoy digital sound such as PCM*, Dolby Digital or DTS. The audio quality is the same as coaxial.
	Coaxial digital audio	 	COAXIAL	Coaxial digital connections allow you to enjoy digital sound such as PCM*, Dolby Digital or DTS. The audio quality is the same as optical.
	Analog audio (RCA)	 L R	White Red	Analog audio connections (RCA) carry analog audio.
	1/8" (3.5 mm) Stereo mini plug	 	MINI PLUG	This cable carries analog audio.

\* Available sampling rate for PCM input signal is 32/44.1/48/88.2/96 kHz. Even 176.4/192 kHz is effective in case of the HDMI connection.

### Note

- The AV receiver does not support SCART plugs.
- The AV receiver's optical digital jacks have shutter-type covers that open when an optical plug is inserted and close when it's removed. Push plugs in all the way.

### Caution

- To prevent shutter damage, hold the optical plug straight when inserting and removing.

## Connecting Components with HDMI

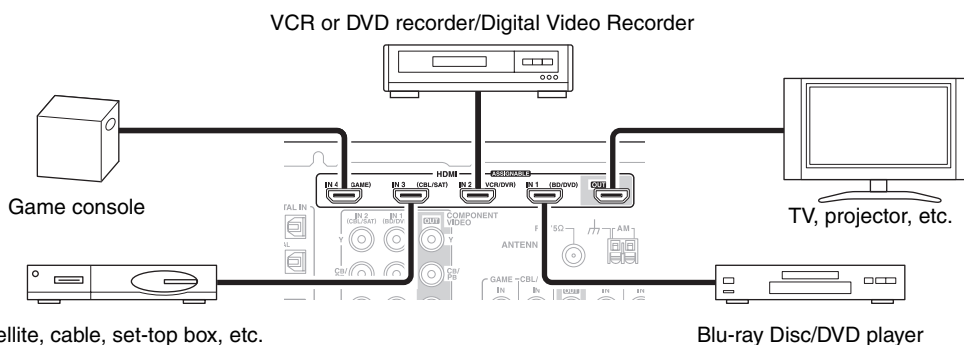

Connect your components to the appropriate jacks. The default input assignments are shown below.

✓: Assignment can be changed (→ 35).

Jack	Signal	Components	Assignable	
Input	HDMI IN1	Audio/Video	Blu-ray Disc/DVD player	✓
	HDMI IN2		VCR or DVD recorder/Digital Video Recorder	✓
	HDMI IN3		Satellite, cable, set-top box, etc.	✓
	HDMI IN4		Game console	✓
Output	HDMI OUT		TV, projector, etc.	

Refer to “About HDMI” (→ 61) and “Using an RIHD-compatible TV, Player, or Recorder” (→ 62).

### Tip

To listen to audio received by the **HDMI IN** jacks through your TV’s speakers:

- Set the “**TV Control**” setting to “**On**” (→ 42) for an **RIHD**-compatible TV.
- Set the “**Audio TV OUT**” setting to “**On**” (→ 41) when the TV is not compatible with **RIHD** or the “**TV Control**” setting to “**Off**”.
- Set your Blu-ray Disc/DVD player’s HDMI audio output setting to PCM.
- To listen to TV audio through the AV receiver, see “Connecting External Components” (→ 16).

### Note

- When listening to an HDMI component through the AV receiver, set the HDMI component so that its video can be seen on the TV screen (on the TV, select the input of the HDMI component connected to the AV receiver). If the TV power is off or the TV is set to another input source, this may result in no sound from the AV receiver or the sound may be cut off.
- When the “**Audio TV OUT**” setting is set to “**On**” (→ 41) to hear from your TV’s speakers, by controlling the AV receiver’s volume, the sound will be output from the AV receiver’s speakers, too. When the “**TV Control**” setting is set to “**On**” (→ 42) to hear from speakers of **RIHD**-compatible TV, by controlling the AV receiver’s volume, the AV receiver’s speakers will produce sound while the TV’s speakers are muted. To stop the AV receiver’s speakers producing sound, change the settings, change your TV’s settings, or turn down the AV receiver’s volume.

### ■ Audio return channel (ARC) function

Audio return channel (ARC) function enables an HDMI capable TV to send the audio stream to the **HDMI OUT** of the AV receiver. To use this function, you must select the **TV/CD** input selector.

- To use ARC function, you must select the **TV/CD** input selector, your TV must support ARC function and “**HDMI Control**” is set to “**On**” (→ 42).

## Connecting External Components

The on-screen setup menus appear only on a TV that is connected to the **HDMI OUT**. If your TV is connected to the **MONITOR OUT V** or the **COMPONENT VIDEO OUT**, use the AV receiver's display when changing settings.

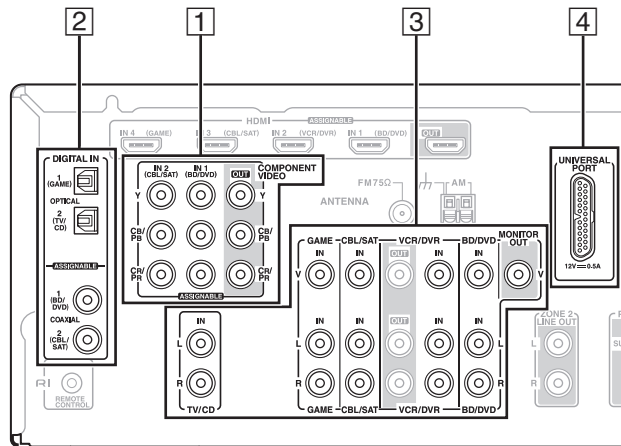

Connect your components to the appropriate jacks. The default input assignments are shown below.

✓: Assignment can be changed (→ 35).

No.	Jack	Signal	Components	Assignable	
1	COMPONENT VIDEO	IN 1 (BD/DVD)	Component video	Blu-ray Disc/DVD player	✓
		IN 2 (CBL/SAT)	Component video	Satellite, cable, set-top box, etc.	✓
		OUT	Component video	TV, projector, etc.	
2	DIGITAL IN	OPTICAL	Digital audio	Game console	✓
		IN 1 (GAME)	Digital audio	TV, CD player	✓
	COAXIAL	IN 2 (TV/CD)	Digital audio	TV, CD player	✓
		IN 1 (BD/DVD)	Digital audio	Blu-ray Disc/DVD player	✓
3	MONITOR OUT	IN 2 (CBL/SAT)	Digital audio	Satellite, cable, set-top box, etc.	✓
		IN 1 (BD/DVD)	Digital audio	Satellite, cable, set-top box, etc.	✓
		OUT	Composite video	TV, projector, etc.	
		BD/DVD IN	Analog audio and composite video	Blu-ray Disc/DVD player	
		VCR/DVR IN	Analog audio and composite video	VCR or DVD recorder/Digital Video Recorder	
		CBL/SAT IN	Analog audio and composite video	Satellite, cable, set-top box, etc.	
4	UNIVERSAL PORT	GAME IN	Analog audio	Game console	
		TV/CD IN	Analog audio	TV, CD player, Turntable*1 Cassette tape deck, MD, CD-R	

\*1 Connect a turntable (MM) that has a phono preamp built-in. If your turntable (MM) doesn't have it, you'll need a commercially available phono preamp.

If your turntable has a moving coil (MC) type cartridge, you'll need a commercially available MC head amp or MC transformer as well as a phono preamp. See your turntable's manual for details.

- With connection 3, you can listen and record audio from the external components while you are in Zone 2. You can listen and record audio from the external components in the main room; you can listen to the audio in Zone 2 as well.
- With connection 2, you can enjoy Dolby Digital and DTS. (To record or listen in Zone 2 as well, use 2 and 3.)
- If your Blu-ray Disc/DVD player has both the main stereo and multichannel outputs, be sure to connect the main stereo output using connection 3.

### How to record the video

With the connections described above, you cannot record the video through the AV receiver. To make a connection for video recording (→ 28).



## Using the AUX INPUT jacks on the front panel

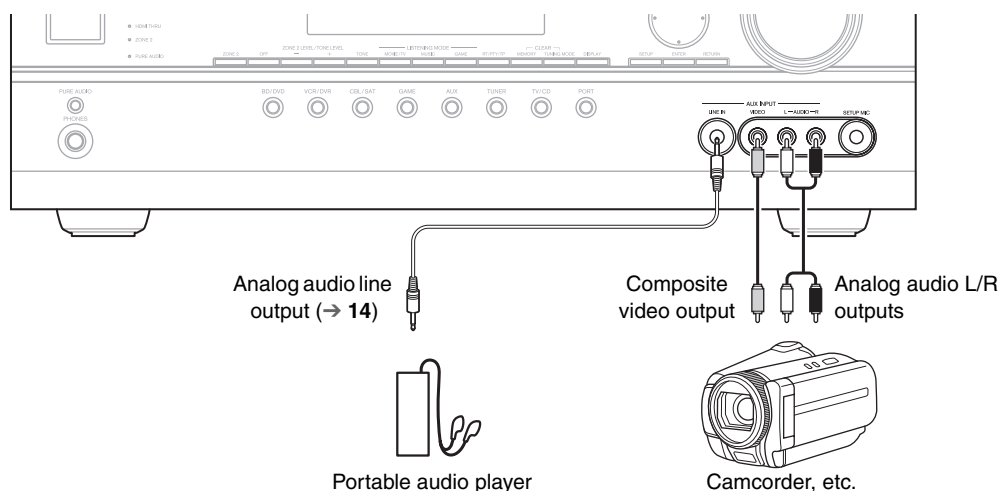

### Note

- When you connect to both **AUX INPUT AUDIO** jacks and **AUX INPUT LINE IN** jack at the same time, **AUX INPUT LINE IN** will be given a higher priority.
- The AV receiver can output audio and video signals from the **AUX INPUT** jacks to the **VCR/DVR OUT** jacks.

## Connecting Onkyo RI Components

### Step 1:

Make sure that each Onkyo component is connected with an analog audio cable (connection 3 in the hookup examples) (→ 16).

### Step 2:

Make the **RI** connection (see illustration below).

### Step 3:

If you're using an RI Dock, or cassette tape deck, change the Input Display (→ 22).

With **RI** (Remote Interactive), you can use the following special functions:

#### ■ System On/Auto Power On

When you start playback on a component connected via **RI**, if the AV receiver is on Standby, it will automatically turn on and select that component as the input source.

#### ■ Direct Change

When playback is started on a component connected via **RI**, the AV receiver automatically selects that component as the input source.

#### ■ Remote Control

You can use the AV receiver's remote controller to control your other **RI**-capable Onkyo components, pointing the remote controller at the AV receiver's remote control sensor instead of the component. You must enter the appropriate remote control code first (→ 53).

### Note

- Use only **RI** cables for **RI** connections. **RI** cables are supplied with Onkyo players (DVD, CD, etc.).
- Some components have two **RI** jacks. You can connect either one to the AV receiver. The other jack is for connecting additional **RI**-capable components.
- Connect only Onkyo components to **RI** jacks. Connecting other manufacturer's components may cause a malfunction.
- Some components may not support all **RI** functions. Refer to the manuals supplied with your other Onkyo components.
- While Zone 2 is on, the System On/Auto Power On and Direct Change **RI** functions do not work.

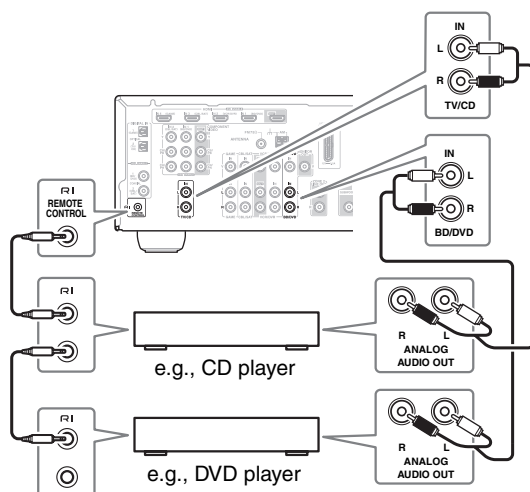

## Connecting Antenna

This section explains how to connect the supplied indoor FM antenna and AM loop antenna.

The AV receiver won't pick up any radio signals without any antenna connected, so you must connect the antenna to use the tuner.

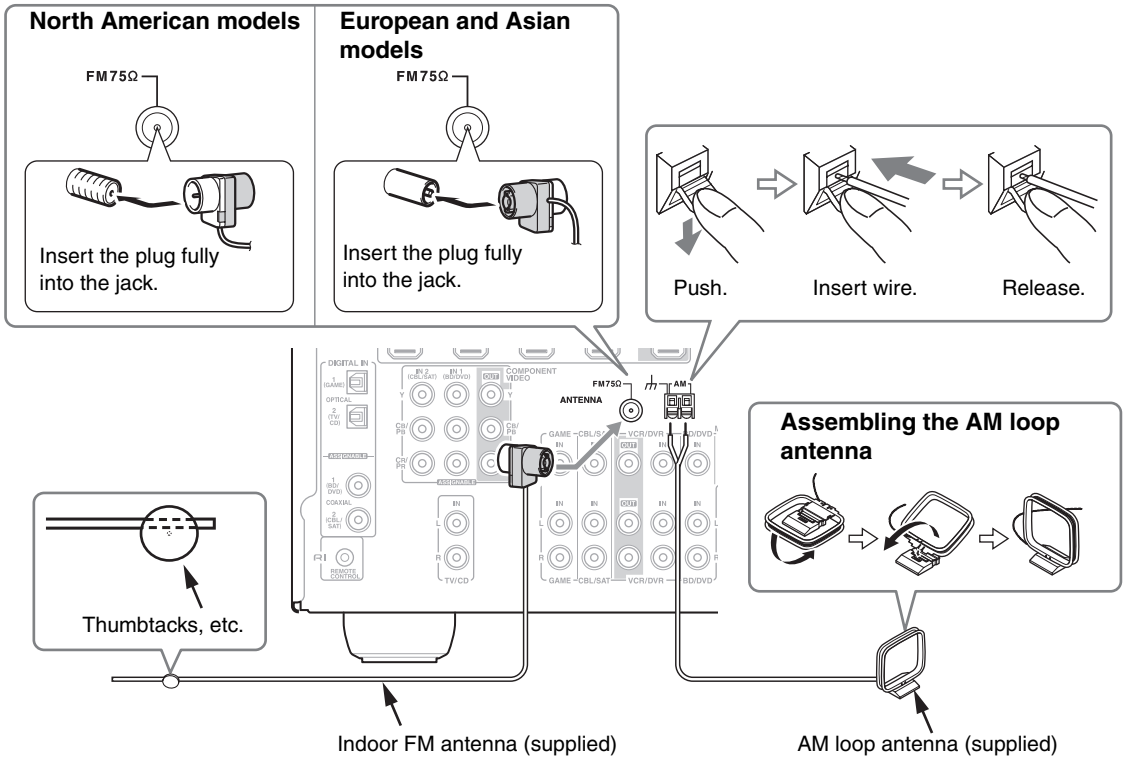

### Caution

- Be careful that you don't injure yourself when using thumbtacks.

### Note

- Once your AV receiver is ready for use, you'll need to tune into a radio station and position the antenna to achieve the best possible reception.
- Keep the AM loop antenna as far away as possible from your AV receiver, TV, speaker cables, and power cords.

### Tip

- If you cannot achieve good reception with the supplied indoor FM antenna, try a commercially available outdoor FM antenna instead.
- If you cannot achieve good reception with the supplied indoor AM loop antenna, try using it with a commercially available outdoor AM antenna.

## Which Connections Should I Use?

The AV receiver supports several connection formats for compatibility with a wide range of AV equipment. The format you choose will depend on the formats supported by your components. Use the following sections as a guide.

**The on-screen setup menus appear only on a TV that is connected to the HDMI OUT. If your TV is connected to the MONITOR OUT V or the COMPONENT VIDEO OUT, use the AV receiver's display when changing settings.**

### Note

The on-screen setup menus are displayed when:

- There is no video input, or
- The video input is 480p, 576p, 720p, 1080i, or 1080p.

## Video Connection Formats

Video component can be connected by using any one of the following video connection formats: composite video, component video, or HDMI, the latter offering the best picture quality.

When choosing a connection format, bear in mind that the AV receiver doesn't convert between formats, so only outputs of the same format as the input will output the signal.

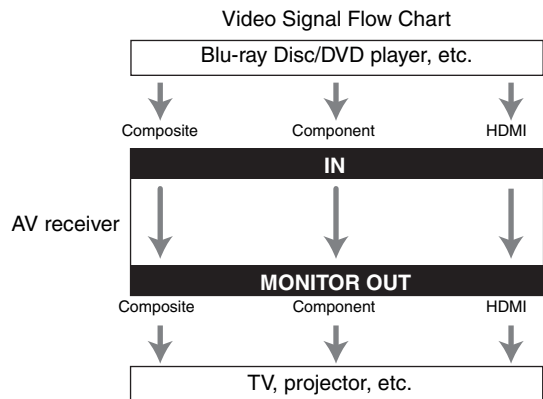

## Audio Connection Formats

Audio component can be connected by using any of the following audio connection formats: analog, optical, coaxial, or HDMI.

When choosing a connection format, bear in mind that the AV receiver does not convert digital input signals for analog line outputs and vice versa. For example, audio signals connected to an optical or coaxial digital input are not output by the analog **VCR/DVR OUT**.

If signals are present at more than one input, the inputs will be selected automatically in the following order of priority: HDMI, digital, analog.

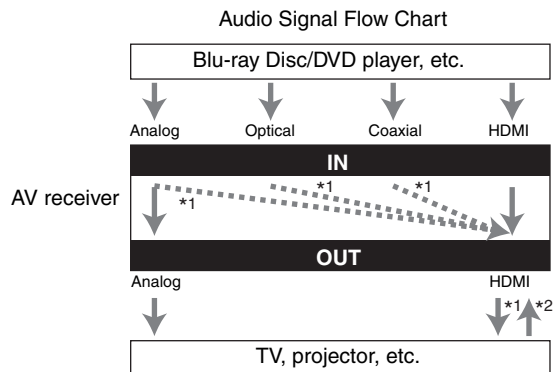

\*1 Depends on the "Audio TV OUT" setting (→ 41).

\*2 This setting is available, when "Audio Return Ch" setting is set to "Auto" (→ 42), you must select the TV/CD input selector and your TV must support ARC function.

# Turning On/Off the AV Receiver

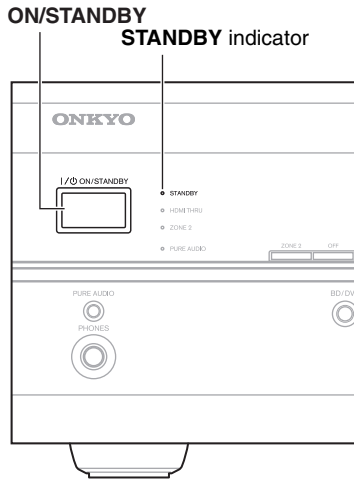

Front panel

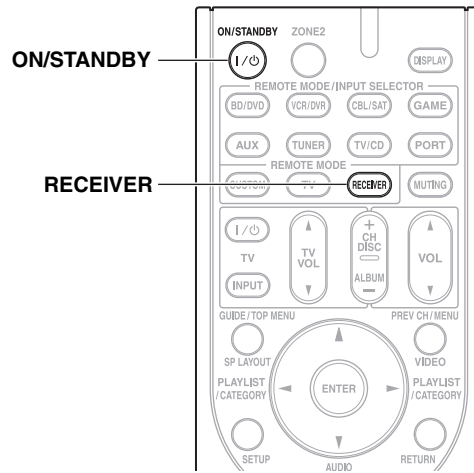

Remote controller

## Turning On

Press **ON/STANDBY** on the front panel.

or

Press **RECEIVER** followed by **ON/STANDBY** on the remote controller.

The AV receiver comes on, the display lights, and the **STANDBY** indicator goes off.

## Turning Off

Press **ON/STANDBY** on the front panel or the remote controller.

The AV receiver will enter Standby mode. To prevent any loud surprises when you turn on the AV receiver, always turn down the volume before you turn it off.

# Basic Operations

This manual describes the procedure using the remote controller unless otherwise specified.

## Playing the Connected Component

### ■ Operating on the AV receiver

**1** Use the input selector buttons to select the input source.

**2** Start playback on the source component.

See also:

- “Controlling Other Components” (→ 53)
- “Controlling iPod” (→ 49)
- “Listening to the Radio” (→ 25)

**3** To adjust the volume, use the MASTER VOLUME control.

**4** Select a listening mode and enjoy!

See also:

- “Using the Listening Modes” (→ 29)
- “Audyssey Settings” (→ 38)

### ■ Operating with the remote controller

**1** Press **RECEIVER** followed by **INPUT SELECTOR**.

**2** Start playback on the source component.

See also:

- “Controlling Other Components” (→ 53)
- “Controlling iPod” (→ 49)
- “Listening to the Radio” (→ 25)

**3** To adjust the volume, use **VOL ▲/▼**.

**4** Select a listening mode and enjoy!

See also:

- “Using the Listening Modes” (→ 29)
- “Audyssey Settings” (→ 38)

## Displaying Source Information

You can display various information about the current input source as follows. (Components connected to the UNIVERSAL PORT jack are excluded.)

Press **RECEIVER** followed by **DISPLAY** repeatedly to cycle through the available information.

### Tip

- Alternatively, you can use the AV receiver’s **DISPLAY**.

The following information can typically be displayed.

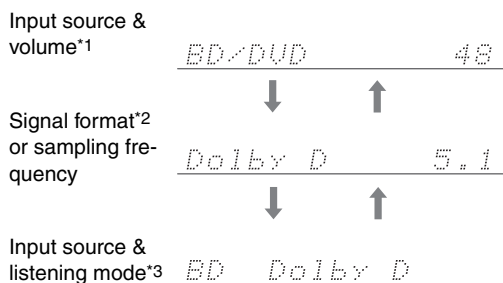

\*1 When AM or FM radio is used, the band, preset number, and frequency are displayed.

\*2 If the input signal is analog, no format information is displayed. If the input signal is PCM, the sampling frequency is displayed. If the input signal is digital but not PCM, the signal format is displayed.

Information is displayed for about three seconds, then the previously displayed information reappears.

\*3 The input source is displayed with the default name even when you have selected a name in “Name Edit” (→ 40).

## Using the Music Optimizer

The Music Optimizer function enhances the sound quality of compressed music files.

**1** Press **AUDIO** and use **▲/▼** to select “M.Optimizer”.

**2** Use **◀/▶** to select “On”.

The M.Opt indicator lights on the display.

### Tip

- Alternatively, you can use the AV receiver’s **MUSIC OPTIMIZER** (North American models).
- See “Music Optimizer” for more details (→ 43).

## Setting the Display Brightness

You can adjust the brightness of the AV receiver’s display.

Press **RECEIVER** followed by **DIMMER** repeatedly to select: dim, dimmer, or normal brightness.

### Tip

- Alternatively, you can use the AV receiver’s **DIMMER** (North American models).

## Muting the AV Receiver

You can temporarily mute the output of the AV receiver.

### Press RECEIVER followed by MUTING.

The output is muted and the **MUTING** indicator flashes on the display.

#### Tip

- To unmute, press **MUTING** again or adjust the volume.
- The Mute function is cancelled when the AV receiver is set to Standby.

## Using the Sleep Timer

With the sleep timer, you can set the AV receiver to turn off automatically after a specified period.

### Press RECEIVER followed by SLEEP repeatedly to select the required sleep time.

The sleep time can be set from 90 to 10 minutes in 10 minute steps.

The **SLEEP** indicator lights on the display when the sleep timer has been set. The specified sleep time appears on the display for about five seconds, then the previous display reappears.

#### Tip

- If you need to cancel the sleep timer, press **SLEEP** repeatedly until the **SLEEP** indicator goes off.
- To check the time remaining until the AV receiver sleeps, press **SLEEP**. Note that if you press **SLEEP** while the sleep time is being displayed, you'll shorten the sleep time by 10 minutes.

## Using Headphones

Connect a pair of stereo headphones with a standard plug (1/4 inch or 6.3 mm) to the **PHONES** jack.

#### Note

- Always turn down the volume before connecting your headphones.
- While the headphones plug is inserted in the **PHONES** jack, the speakers are turned off. (The Powered Zone 2 speakers are not turned off.)
- When you connect a pair of headphones, the listening mode is set to Stereo, unless it's already set to Stereo, Mono, Direct, or Pure Audio (**European and Asian models**).
- Only the Stereo, Direct, Pure Audio (**European and Asian models**), and Mono listening modes can be used with headphones.

## Changing the Input Display

When you connect an **RI**-capable Onkyo component, you must configure the input display so that **RI** can work properly.

This setting can be done only from the front panel.

### 1 Press TV/CD, GAME or VCR/DVR on the front panel so that "TV/CD", "GAME" or "VCR/DVR" appears on the display.

TV/CD

GAME

VCR/DVR

### 2 Press and hold down TV/CD, GAME or VCR/DVR (about 3 seconds) to change the input display.

Repeat this step to select "MD", "CDR", "DOCK" or "TAPE".

For the **TV/CD** input selector, the input display changes in this order:

TV/CD → MD → CDR  
↑ TAPE ← DOCK ↓

For the **GAME** input selector, the setting changes in this order:

GAME ↔ DOCK

For the **VCR/DVR** input selector, the setting changes in this order:

VCR/DVR ↔ DOCK

#### Note

- **DOCK** can be selected for the **TV/CD**, **GAME** or **VCR/DVR** input selector, but not at the same time.
- Enter the appropriate remote control code before using the remote controller for the first time (→ 53).

## Selecting Speaker Layout

You can select the priority of the use of front high or surround back speakers.

### Press RECEIVER followed by SP LAYOUT repeatedly.

#### ▶ FrontHigh:

The sound from front high speakers is output by priority.

#### ▶ SurroundBack:

The sound from surround back speakers is output by priority.

#### Note

- If the "Speakers Type" setting is set to "Bi-AMP" (→ 40), or Powered Zone 2 is being used (→ 47), this setting cannot be selected.
- When the listening mode that doesn't support front high or surround back speakers is used, the setting cannot be selected.

## Audyssey 2EQ® Room Correction and Speaker Setup

With the supplied calibrated microphone, Audyssey 2EQ automatically determines the number of speakers connected, their size for purposes of bass management, optimum crossover frequencies to the subwoofer (if present), and distances from the primary listening position.

Audyssey 2EQ then removes the distortion caused by room acoustics by capturing room acoustical problems over the listening area in both the frequency and time domain. The result is clear, well-balanced sound for everyone.

Enabling Audyssey 2EQ allows you to also use Audyssey Dynamic EQ™, which maintains the proper octave-to-octave balance at any volume level (→ 38).

Before using this function, connect and position all of your speakers.

If “Dynamic EQ” is set to “On” (→ 39), the “Audyssey” setting will be set to “Off” (→ 38). On the other hand, if it is set to “Off”, the “Dynamic Volume” setting will be set to “Off” (→ 39).

It takes about 15 minutes to complete Audyssey 2EQ Room Correction and Speaker Setup for three positions. Total measurement time varies depending on the number of speakers.

### Using Audyssey 2EQ

To create a listening environment in your home theater that all listeners will enjoy, Audyssey 2EQ takes measurements at up to three positions within the listening area. Position the microphone at ear height of a seated listener with the microphone tip pointed directly at the ceiling using a tripod. Do not hold the microphone in your hand during measurements as this will produce inaccurate results.

#### ① First measurement position

Also referred to as the Main Listening Position this refers to the most central position where one would normally sit within the listening environment. 2EQ uses the measurements from this position to calculate speaker distance, level, polarity, and the optimum crossover value for the subwoofer.

#### ② Second measurement position

The right side of the listening area.

#### ③ Third measurement position

The left side of the listening area.

The distances from position ① to ② and ① to ③ must be at least 1 meter.

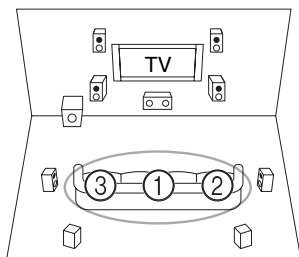

○: Listening area

① to ③: Listening position

### Note

- Make the room as quiet as possible. Background noise and Radio Frequency Interference (RFI) can disrupt the room measurements. Close windows, televisions, radios, air conditioners, fluorescent lights, home appliances, light dimmers, or other devices. Silence the cell phone (even if it is not in use) or place it away from all audio electronics.
- The microphone picks up test tones which played through each speaker as Audyssey 2EQ Room Correction and Speaker Setup run.
- Audyssey 2EQ Room Correction and Speaker Setup cannot be performed while a pair of headphones is connected.

### 1 Turn on the AV receiver and the connected TV.

On the TV, select the input to which the AV receiver is connected.

### 2 Set the speaker setup microphone at the Main Listening Position 1, and connect it to the SETUP MIC jack.

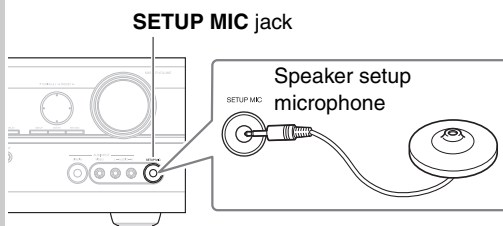

The speaker setting menu appears.

### Note

- The on-screen setup menus appear only on a TV that is connected to the **HDMI OUT**. If your TV is connected to the **MONITOR OUT V** or the **COMPONENT VIDEO OUT**, use the AV receiver's display when changing settings.

### 3 When you've finished making the settings, press ENTER.

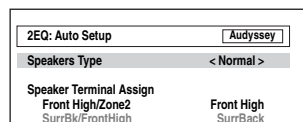

If your front speakers are bi-amped, you must select “Bi-AMP” in the “Speakers Type” setting (→ 40). For hookup information, see “Bi-amping the Front Speakers” (→ 13).

### 4 Press ENTER.

Audyssey 2EQ Room Correction and Speaker Setup starts.

Test tones are played through each speaker as Audyssey 2EQ Room Correction and Speaker Setup runs. This process takes a few minutes. Please **refrain from talking** during measurements and **do not stand** between speakers and the microphone.

Do not disconnect the speaker setup microphone during Audyssey 2EQ Room Correction and Speaker Setup, unless you want to cancel the setup.

## 5 Place the setup microphone at the next position, and then press ENTER.

Audyssey 2EQ® performs more measurements. This takes a few minutes.

## 6 When prompted, place the setup microphone at the next position, and repeat step 5.

## 7 Use ▲/▼ to select an option, and then press ENTER.

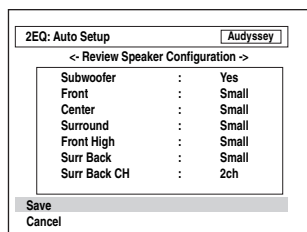

The options are:

- ▶ **Save:**  
Save the calculated settings and exit Audyssey 2EQ Room Correction and Speaker Setup.
- ▶ **Cancel:**  
Cancel Audyssey 2EQ Room Correction and Speaker Setup.

### Note

- You can view the calculated settings for the speaker configuration, speaker distances, and speaker levels by using ◀/▶.

## 8 Disconnect the speaker setup microphone.

### Note

- When Audyssey 2EQ Room Correction and Speaker Setup is complete, the “Audyssey” will be set to “On” (→ 38). The Audyssey indicator will light (→ 8).
- You can cancel Audyssey 2EQ Room Correction and Speaker Setup at any point in this procedure simply by disconnecting the setup microphone.
- Do not connect or disconnect any speakers during Audyssey 2EQ Room Correction and Speaker Setup.
- If the AV receiver is muted, it will be unmuted automatically when Audyssey 2EQ Room Correction and Speaker Setup starts.
- Changes to the room after Audyssey 2EQ Room Correction and Speaker Setup requires you run Audyssey 2EQ Room Correction and Speaker Setup again, as room EQ characteristics may have changed.

## Error Messages

While Audyssey 2EQ Room Correction and Speaker Setup is in progress, one of the error messages below may appear.

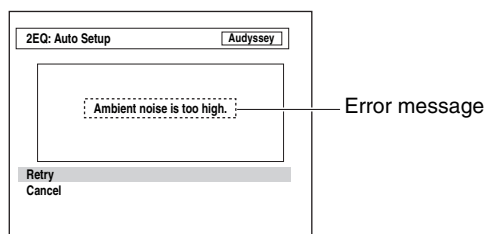

The options are:

- ▶ **Retry:**  
Try again.
- ▶ **Cancel:**  
Cancel Audyssey 2EQ Room Correction and Speaker Setup.
- **Ambient noise is too high.**  
The background noise is too loud. Remove the source of the noise and try again.
- **Speaker matching error!**  
The number of speakers detected was different from that of the first measurement. Check the speaker connection.
- **Writing Error!**  
This message appears if saving fails. Try saving again. If this message appears after 2 or 3 attempts, contact your Onkyo dealer.
- **Speaker Detect Error**  
This message appears if a speaker is not detected. “No” means that no speaker was detected.

### Tip

- See “Speaker Configuration” for appropriate settings (→ 11).

## Changing the Speaker Settings Manually

You can manually make changes to the settings found during Audyssey 2EQ Room Correction and Speaker Setup. See also:

- “Sp Config (Speaker Configuration)” (→ 36)
- “Sp Distance (Speaker Distance)” (→ 37)
- “Level Cal (Level Calibration)” (→ 37)

## Using a Powered Subwoofer

If you’re using a powered subwoofer and it outputs very low-frequency sound at a low volume level, it may not be detected by Audyssey 2EQ Room Correction and Speaker Setup.

If the “Subwoofer” appears on the “Review Speaker Configuration” screen as “No”, increase the subwoofer’s volume to the half-way point, set it to its highest crossover frequency, and then try running Audyssey 2EQ Room Correction and Speaker Setup again. Note that if the volume is set too high and the sound distorts, detection issues may occur, so use an appropriate volume level. If the subwoofer has a low-pass filter switch, set it to Off or Direct. Refer to your subwoofer’s instruction manual for details.



# Listening to the Radio

This section describes the procedure using the buttons on the front panel unless otherwise specified.

## Using the Tuner

With the built-in tuner you can enjoy AM and FM radio stations. You can store your favorite stations as presets for quick selection.

This model changes FM/AM frequency in 200/10kHz (or 50/9kHz) steps.

## Listening to the Radio

Press **TUNER** to select either “AM” or “FM”.

In this example, FM has been selected.

Each time you press **TUNER**, the radio band changes between AM and FM.

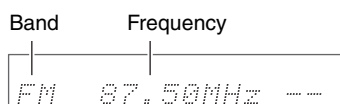

(Actual display depends on the country.)

## Tuning into Radio Stations

### ■ Auto tuning mode

**1** Press **TUNING MODE** so that the **AUTO** indicator lights on the display.

**2** Press **TUNING ▲/▼**.

Searching stops when a station is found.

When tuned into a station, the **TUNED** indicator lights. When tuned into a stereo FM station, the **FM STEREO** indicator lights on the display, as shown.

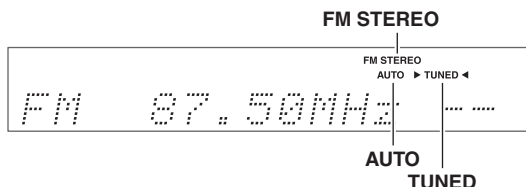

### ■ Manual tuning mode

**1** Press **TUNING MODE** so that the **AUTO** indicator goes off on the display.

**2** Press and hold **TUNING ▲/▼**.

The frequency stops changing when you release the button.

Press the buttons repeatedly to change the frequency one step at a time.

In manual tuning mode, FM stations will be in mono.

### Tuning into weak FM stereo stations

If the signal from a stereo FM station is weak, it may be impossible to get good reception. In this case, switch to manual tuning mode and listen to the station in mono.

### ■ Tuning into stations by frequency

You can tune into AM and FM stations directly by entering the appropriate frequency.

**1** On the remote controller, press **TUNER** repeatedly to select “AM” or “FM”, followed by **D.TUN**.

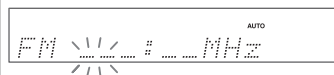

(Actual display depends on the country.)

**2** Within **8 seconds**, use the number buttons to enter the frequency of the radio station.

For example, to tune to 87.50 (FM), press 8, 7, 5, 0.

If you have entered the wrong number, you can retry after 8 seconds.

## Presetting FM/AM Stations

You can store a combination of up to 40 of your favorite FM/AM radio stations as presets.

### 1 Tune into the FM/AM station that you want to store as a preset.

See the previous section.

### 2 Press MEMORY.

The preset number flashes.



### 3 While the preset number is flashing (about 8 seconds), use PRESET ◀/▶ to select a preset from 1 through 40.

### 4 Press MEMORY again to store the station or channel.

The station or channel is stored and the preset number stops flashing.

Repeat this procedure for all of your favorite FM/AM radio stations.

## Selecting Presets

To select a preset, use PRESET ◀/▶ on the AV receiver, or the remote controller's CH +/-.

#### Tip

- You can also use the remote controller's number buttons to select a preset directly.

## Deleting Presets

### 1 Select the preset that you want to delete.

See the previous section.

### 2 While holding down MEMORY, press TUNING MODE.

The preset is deleted and its number disappears from the display.

## Using RDS (excluding North American models)

RDS works only in areas where RDS broadcasts are available.

When tuned into an RDS station, the RDS indicator lights.

## What is RDS?

RDS stands for Radio Data System and is a method of transmitting data in FM radio signals. It was developed by the European Broadcasting Union (EBU) and is available in most European countries. Many FM stations use it these days. In addition to displaying text information, RDS can also help you find radio stations by type (e.g., news, sport, rock, etc.).

The AV receiver supports four types of RDS information:

#### ■ PS (Program Service)

When tuned to an RDS station that's broadcasting PS information, the station's name will be displayed. Pressing **DISPLAY** will display the frequency for 3 seconds.

#### ■ RT (Radio Text)

When tuned to an RDS station that's broadcasting text information, the text will be shown on the display as described in the next section.

#### ■ PTY (Program Type)

This allows you to search for RDS radio stations by type (→ 27).

#### ■ TP (Traffic Program)

This allows you to search for RDS radio stations that broadcast traffic information (→ 27).

#### Note

- In some cases, the text characters displayed on the AV receiver may not be identical to those broadcast by the radio station. Also, unexpected characters may be displayed when unsupported characters are received. This is not a malfunction.
- If the signal from an RDS station is weak, RDS data may be displayed intermittently or not at all.

When tuned to an RDS station that's broadcasting text information, the text can be displayed.

## Displaying Radio Text (RT)

Press RT/PTY/TP once.

The RT information scrolls across the display.

#### Note

- The message "**Waiting**" may appear while the AV receiver waits for the RT information.
- If the message "**No Text Data**" appears on the display, no RT information is available.

## Finding Stations by Type (PTY)

You can search for radio stations by type.

- 1 Press RT/PTY/TP twice.**  
The current program type appears on the display.
- 2 Use PRESET ◀/▶ to select the type of program you want.**  
See the table shown later in this chapter.
- 3 To start the search, press ENTER.**  
The AV receiver searches until it finds a station of the type you specified, at which point it stops briefly before continuing with the search.
- 4 When a station you want to listen to is found, press ENTER.**  
If no stations are found, the message “Not Found” appears.

## Listening to Traffic News (TP)

You can search for stations that broadcast traffic news.

- 1 Press RT/PTY/TP three times.**  
If the current radio station is broadcasting TP (Traffic Program), “[TP]” will appear on the display, and traffic news will be heard as and when it’s broadcast. If “TP” without square brackets appears, this means that the station is not broadcasting TP.
- 2 To locate a station that is broadcasting TP, press ENTER.**  
The AV receiver searches until it finds a station that’s broadcasting TP.  
If no stations are found, the message “Not Found” appears.

## ■ RDS program types (PTY)

Type	Display
None	None
News reports	News
Current affairs	Affairs
Information	Info
Sport	Sport
Education	Educate
Drama	Drama
Culture	Culture
Science and technology	Science
Varied	Varied
Pop music	Pop M
Rock music	Rock M
Middle of the road music	Easy M
Light classics	Light M
Serious classics	Classics
Other music	Other M
Weather	Weather
Finance	Finance
Children’s programmes	Children
Social affairs	Social
Religion	Religion
Phone in	Phone In
Travel	Travel
Leisure	Leisure
Jazz music	Jazz
Country music	Country
National music	Nation M
Oldies music	Oldies
Folk music	Folk M
Documentary	Document
Alarm test	TEST
Alarm	Alarm!

# Recording

This section explains how to record the selected input source to a component with recording capability, and how to record audio and video from different sources.

## Connecting a Recording Component

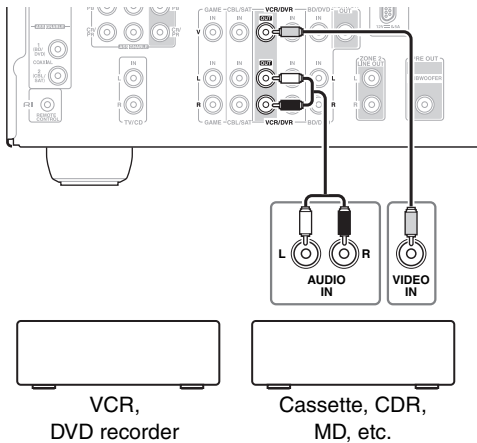

### Note

- The AV receiver must be turned on for recording. Recording is not possible while it's in Standby mode.
- If you want to record directly from your TV or playback VCR to the recording VCR without going through the AV receiver, connect the TV/VCR's audio and video outputs directly to the recording VCR's audio and video inputs. See the manuals supplied with your TV and VCR for details.
- Video signals connected to composite video inputs can be recorded only via composite video outputs. If your TV/VCR is connected to a composite video input, the recording VCR must be connected to a composite video output.
- The surround sound and DSP listening modes cannot be recorded.
- Copy-protected Blu-ray discs and DVDs cannot be recorded.
- Sources connected to a digital input cannot be recorded. Only analog inputs can be recorded.
- DTS signals will be recorded as noise, so don't attempt analog recording of DTS CDs or LDs.
- While the listening mode is set to Pure Audio, no image is provided because the power is turned off for the video circuit. If you want to make recordings, select other listening mode. (European and Asian models)

## AV Recording

Audio sources can be recorded to a recorder (e.g., cassette deck, CDR, MD) connected to the **VCR/DVR OUT** jacks. Video sources can be recorded to a video recorder (e.g., VCR, DVD recorder) connected to the **VCR/DVR OUT** jack.

### 1 Use the input selector buttons to select the source that you want to record.

You can watch the source while recording. The AV receiver's **MASTER VOLUME** control has no effect on recording.

### 2 On your recorder, start recording.

### 3 On the source component, start playback.

If you select another input source during recording, that input source will be recorded.

## Recording Separate AV Sources

Here you can record audio and video from completely separate sources, allowing you to overdub audio onto your video recordings. This function takes advantage of the fact that when an audio-only input source (TV/CD) is selected, the video input source remains unchanged.

In the following example, audio from the CD player connected to the **TV/CD IN** and video from the camcorder connected to the **AUX INPUT VIDEO** jack are recorded by the VCR connected to the **VCR/DVR OUT** jacks.

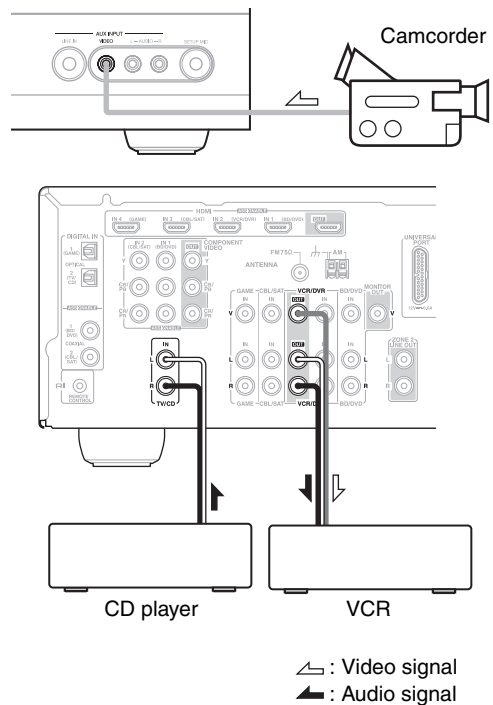

### 1 Prepare the camcorder and CD player for playback.

### 2 Prepare the VCR for recording.

### 3 Press AUX input selector.

### 4 Press TV/CD input selector.

This selects the CD player as the audio source, but leaves the camcorder as the video source.

### 5 Start recording on the VCR and start playback on the camcorder and CD player.

The video from the camcorder and the audio from the CD player are recorded by the VCR.

# Using the Listening Modes

## Selecting Listening Modes

See “About Listening Modes” for detailed information about the listening modes (→ 30).

## Listening Mode Buttons

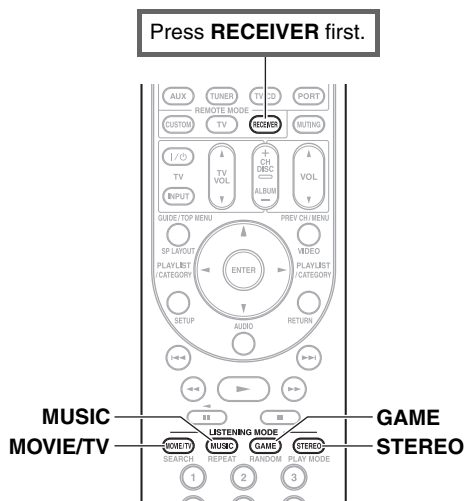

### MOVIE/TV button

This button selects the listening modes intended for use with movies and TV.

### MUSIC button

This button selects the listening modes intended for use with music.

### GAME button

This button selects the listening modes intended for use with video games.

### STEREO button

This button selects the Stereo listening mode and All Channel Stereo listening mode.

### (North American models)

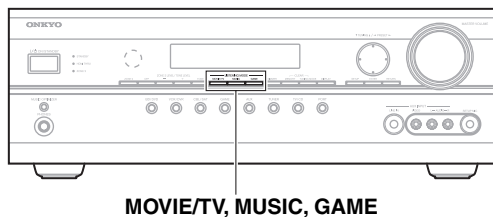

MOVIE/TV, MUSIC, GAME

### (European and Asian models)

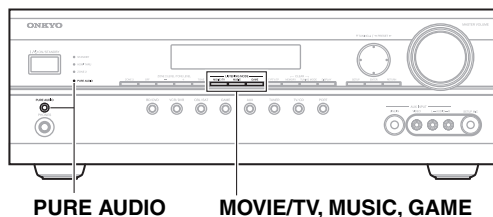

PURE AUDIO MOVIE/TV, MUSIC, GAME

### PURE AUDIO button and indicator

#### (European and Asian models)

This button selects the Pure Audio listening mode. When this mode is selected, the AV receiver's display and video circuitry are turned off. The indicator lights when this mode is selected. Pressing this button again will select the previous listening mode.

- The Dolby Digital and DTS listening modes can only be selected if your Blu-ray Disc/DVD player is connected to the AV receiver with a digital audio connection (coaxial, optical, or HDMI).
- The listening modes you can select depends on the format of the input signal. To check the format, see “Displaying Source Information” (→ 21).
- While a pair of headphones is connected, you can select the following listening modes: Pure Audio (European and Asian models), Mono, Direct, and Stereo.

## About Listening Modes

The AV receiver's listening modes can transform your listening room into a movie theater or concert hall, with high fidelity and stunning surround sound.

### Explanatory Notes

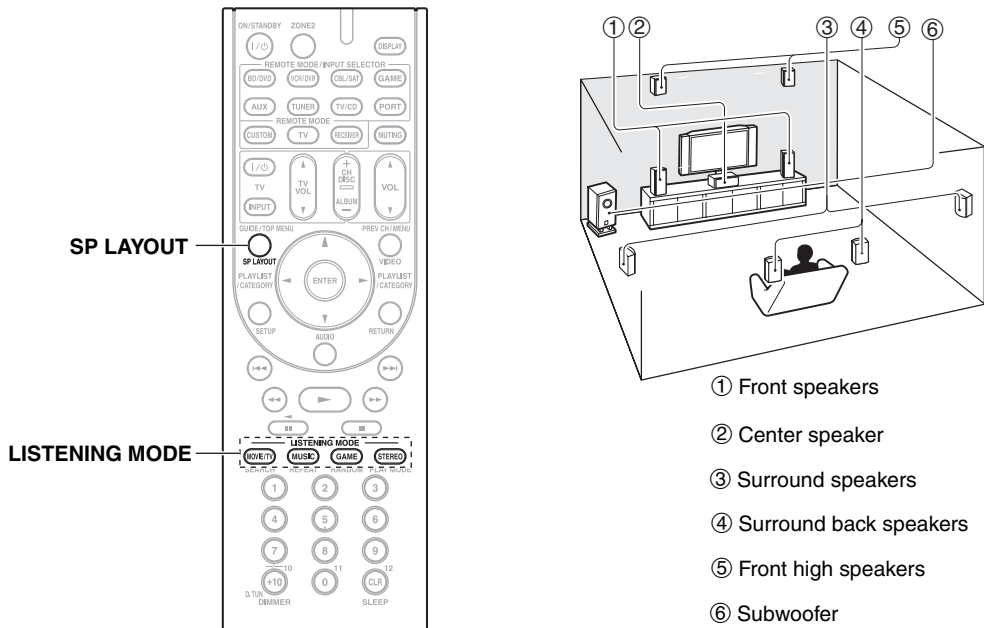

#### ■ Input Source

The following audio formats are supported by the listening mode.

<b>MONO</b>	This is mono (monophonic) sound.
<b>STEREO</b>	This is stereo (stereophonic) sound. Two independent audio signal channels are reproduced through two speakers.
<b>5.1ch</b>	This is 5.1-channel surround sound. This surround system has five main channels of sound and a sixth subwoofer channel (called the point-one channel).
<b>7.1ch</b>	This is 7.1-channel surround sound. This is a further sound enhancement to 5.1 channel sound with two additional speakers that provide greater sound envelopment and more accurate positioning of sounds.
<b>DTS-ES</b>	This is DTS-ES surround sound. This surround system can produce a discrete or a matrix-encoded sixth channel from existing DTS 5.1 encoded material.
<b>DXEX</b>	This is Dolby Digital EX surround sound. This provides a center back surround channel from 5.1-channel sources.

#### ■ Speaker Layout

The illustration shows which speakers are activated in each channel. See “Sp Config (Speaker Configuration)” for the speaker setup (→ 36).

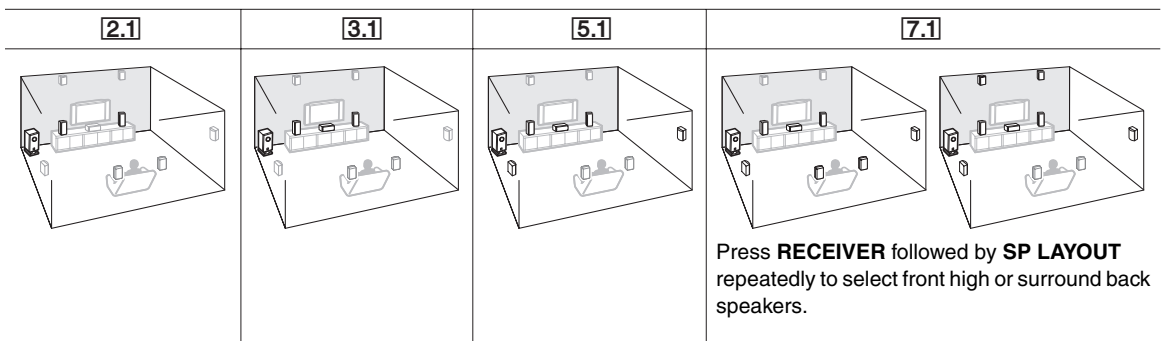

## Listening Modes

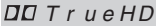
Listening Mode	Description	Input Source	Speaker Layout
<b>Pure Audio</b> <sup>*1</sup> <i>Pure Audio</i>	In this mode, the display and video circuitry are turned off, minimizing possible noise sources for the ultimate in high-fidelity audio reproduction. (As the video circuitry is turned off, only video signals input through <b>HDMI IN</b> can be output from <b>HDMI OUT</b> .)	<b>MONO</b> <b>STEREO</b> <b>5.1ch</b> <b>7.1ch</b>	<b>2.1</b> <b>3.1</b> <b>5.1</b> <b>7.1</b> <sup>*2</sup>
<b>Direct</b> <i>Direct</i>	In this mode, audio from the input source is output without surround-sound processing. The “ <b>Sp Config</b> ” (presence of speakers), “ <b>Sp Distance</b> ” and “ <b>A/V Sync</b> ” settings are enabled, but much of the processing set via <b>AUDIO</b> is disabled. See “Advanced Setup” for more details (→ 34).	<b>DTS-ES</b> <b>DDEX</b>	
<b>Stereo</b> <i>Stereo</i>	Sound is output by the front left and right speakers and subwoofer.	<b>MONO</b> <b>STEREO</b> <b>5.1ch</b>	<b>2.1</b> <b>3.1</b> <b>5.1</b> <b>7.1</b>
<b>Mono</b> <i>Mono</i>	Use this mode when watching an old movie with a mono soundtrack, or use it with the foreign language soundtracks recorded in the left and right channels of some movies. It can also be used with DVDs or other sources containing multiplexed audio, such as karaoke DVDs.	<b>7.1ch</b> <b>DTS-ES</b> <b>DDEX</b>	
<b>Multichannel</b> <i>Multich</i>	This mode is for use with PCM multichannel sources.	<b>5.1ch</b>	<b>3.1</b> <b>5.1</b> <b>7.1</b>
<b>Dolby Pro Logic IIx</b> <sup>*3</sup> <b>Dolby Pro Logic II</b> <i>PLII Movie</i> <i>PLII Music</i> <i>PLII Game</i> <i>PLIIx Movie</i> <i>PLIIx Music</i> <i>PLIIx Game</i>	<p><b>Dolby Pro Logic IIx</b> expands any 2-channel source for 7.1-channel playback. It provides a very natural and seamless surround-sound experience that fully envelops the listener. As well as music and movies, video games can also benefit from the dramatic spatial effects and vivid imaging. If you're not using any surround back speakers, <b>Dolby Pro Logic II</b> will be used instead of Dolby Pro Logic IIx.</p> <ul style="list-style-type: none"> <li>• <b>Dolby PLIIx Movie</b> Use this mode with any stereo or Dolby Surround (Pro Logic) movie (e.g., TV, DVD, VHS).</li> <li>• <b>Dolby PLIIx Music</b> Use this mode with any stereo or Dolby Surround (Pro Logic) music source (e.g., CD, radio, cassette, TV, VHS, DVD).</li> <li>• <b>Dolby PLIIx Game</b> Use this mode with video games, especially those that bear the Dolby Pro Logic II logo.</li> </ul>	<b>STEREO</b>	<b>3.1</b> <b>5.1</b> <b>7.1</b>
	<ul style="list-style-type: none"> <li>• <b>Dolby PLIIx Movie, Dolby PLIIx Music</b> These modes use the Dolby Pro Logic IIx modes to expand 5.1-channel sources for 7.1-channel playback.</li> </ul>	<b>5.1ch</b>	<b>7.1</b>
<b>Dolby Pro Logic IIz Height</b> <i>PLIIz Height</i>	<b>Dolby Pro Logic IIz Height</b> is designed to more effectively use existing program material when height channel speaker outputs are present. <b>Dolby Pro Logic IIz Height</b> can be used to upmix a variety of sources from movies and music, but are particularly well-suited to upmix game content.	<b>STEREO</b> <b>5.1ch</b> <b>7.1ch</b>	<b>7.1</b> <sup>*4</sup>
<b>Dolby EX</b> <i>Dolby EX</i> <i>Dolby D EX</i>	These modes expand 5.1-channel sources for 6.1/7.1-channel playback. They're especially suited to Dolby EX soundtracks that include a matrix-encoded surround back channel. The additional channel adds an extra dimension and provides an enveloping surround sound experience, perfect for rotating and fly-by sound effects.	<b>5.1ch</b> <b>DDEX</b>	<b>7.1</b> <sup>*5</sup>
<b>Dolby Digital</b> <i>Dolby D</i>	In this mode, audio from the input source is output without surround-sound processing. “ <b>Sp Config</b> ” (presence of speakers), “ <b>Crossover</b> ”, “ <b>Sp Distance</b> ”, “ <b>A/V Sync</b> ” and much of the processing set via <b>AUDIO</b> are enabled.	<b>5.1ch</b>	<b>3.1</b> <b>5.1</b> <b>7.1</b>
<b>Dolby Digital Plus</b> <sup>*6</sup> <i>Dolby D+</i>	See “Advanced Setup” for more details (→ 34).	<b>5.1ch</b> <b>7.1ch</b>	<b>3.1</b> <b>5.1</b> <b>7.1</b> <b>7.1</b> <sup>*2</sup>
<b>Dolby TrueHD</b> 		<b>5.1ch</b> <b>7.1ch</b>	<b>3.1</b> <b>5.1</b> <b>7.1</b> <b>7.1</b> <sup>*2</sup>
<b>DTS</b> <i>DTS</i>		<b>5.1ch</b>	<b>3.1</b> <b>5.1</b> <b>7.1</b>

Listening Mode	Description	Input Source	Speaker Layout	
<b>DTS-HD High Resolution Audio</b> <i>DTS-HD HR</i>	(Continued from the previous page )	<b>5.1ch</b>	<b>3.1</b>   <b>5.1</b>   <b>7.1</b>	
		<b>7.1ch</b>	<b>3.1</b>   <b>5.1</b>   <b>7.1</b> * <sup>2</sup>	
<b>DTS-HD Master Audio</b> <i>DTS-HD MSTR</i>		<b>5.1ch</b>	<b>3.1</b>   <b>5.1</b>   <b>7.1</b>	
		<b>7.1ch</b>	<b>3.1</b>   <b>5.1</b>   <b>7.1</b> * <sup>2</sup>	
<b>DTS Express</b> <i>DTS Express</i>		<b>STEREO</b>	<b>3.1</b>   <b>5.1</b>   <b>7.1</b>	
		<b>5.1ch</b>		
<b>DSD<sup>7</sup></b> <i>DSD</i>		<b>5.1ch</b>	<b>3.1</b>   <b>5.1</b>   <b>7.1</b>	
<b>DTS 96/24<sup>8</sup></b> <i>DTS 96/24</i>		This mode is for use with DTS 96/24 sources. This is high-resolution DTS with a 96 kHz sampling rate and 24-bit resolution, providing superior fidelity. Use it with DVDs that bear the DTS 96/24 logo.	<b>5.1ch</b>	<b>3.1</b>   <b>5.1</b>   <b>7.1</b>
<b>DTS-ES Discrete<sup>9</sup></b> <i>ES Discrete</i>		This mode is for use with DTS-ES Discrete soundtracks, which use a discrete surround back channel for true 6.1/7.1-channel playback. The seven totally separate audio channels provide better spatial imaging and 360-degree sound localization, perfect for sounds that pan across the surround channels. Use it with DVDs that bear the DTS-ES logo, especially those with a DTS-ES Discrete soundtrack.	<b>DTS-ES</b>	<b>7.1</b> * <sup>5</sup>
<b>DTS-ES Matrix<sup>9</sup></b> <i>ES Matrix</i>	This mode is for use with DTS-ES Matrix soundtracks, which use a matrix-encoded back-channel for 6.1/7.1-channel playback. Use it with DVDs that bear the DTS-ES logo, especially those with a DTS-ES Matrix soundtrack.	<b>DTS-ES</b>	<b>7.1</b> * <sup>5</sup>	
<b>DTS Neo:6</b> <i>Neo:6</i> <i>Neo:6 Cinema</i> <i>Neo:6 Music</i>	This mode expands any 2-channel source for up to 7.1-channel playback. It uses seven full-bandwidth channels of matrix decoding for matrix-encoded material, providing a very natural and seamless surround sound experience that fully envelops the listener. • <b>Neo:6 Cinema</b> Use this mode with any stereo movie (e.g., TV, DVD, VHS). • <b>Neo:6 Music</b> Use this mode with any stereo music source (e.g., CD, radio, cassette, TV, VHS, DVD).	<b>STEREO</b>	<b>3.1</b>   <b>5.1</b>   <b>7.1</b> * <sup>5</sup>	
		<b>5.1ch</b>	<b>7.1</b> * <sup>5</sup>	
	This mode uses Neo:6 to expand 5.1-channel sources for 6.1/7.1-channel playback.			



## Onkyo-Original DSP Listening Modes

Listening Mode	Description	Input Source	Speaker Layout		
<b>Orchestra</b> <i>Orchestra</i>	Suitable for classical or operatic music, this mode emphasizes the surround channels in order to widen the stereo image, and simulates the natural reverberation of a large hall.	<b>MONO</b> <b>STEREO</b> <b>5.1ch</b> <b>DTS-ES</b> <b>DDEX</b>	<b>5.1</b> <b>7.1</b> *10		
<b>Unplugged</b> <i>Unplugged</i>	Suitable for acoustic instruments, vocals, and jazz, this mode emphasizes the front stereo image, giving the impression of being right in front of the stage.				
<b>Studio-Mix</b> <i>Studio-Mix</i>	Suitable for rock or pop music, listening to music in this mode creates a lively sound field with a powerful acoustic image, like being at a club or rock concert.				
<b>TV Logic</b> <i>TV Logic</i>	This mode adds realistic acoustics to TV shows produced in a TV studio, surround effects to the entire sound, and clarity to voices.				
<b>Game-RPG</b> <i>Game-RPG</i>	Use this mode when playing role playing game discs.				
<b>Game-Action</b> <i>Game-Action</i>	Use this mode when playing action game discs.				
<b>Game-Rock</b> <i>Game-Rock</i>	Use this mode when playing rock game discs.				
<b>Game-Sports</b> <i>Game-Sports</i>	Use this mode when playing sports game discs.				
<b>All Ch Stereo</b> <i>All Ch St</i>	Ideal for background music, this mode fills the entire listening area with stereo sound from the front, surround, and surround back speakers.			<b>MONO</b> <b>STEREO</b> <b>5.1ch</b> <b>7.1ch</b> <b>DTS-ES</b> <b>DDEX</b>	<b>3.1</b> <b>5.1</b> <b>7.1</b> *10
<b>Full Mono</b> <i>Full Mono</i>	In this mode, all speakers output the same sound in mono, so the sound you hear is the same regardless of where you are within the listening room.				
<b>T-D (Theater-Dimensional)</b> <i>T-D</i>	With this mode you can enjoy a virtual surround sound even with only two or three speakers. This works by controlling how sounds reach the listener's left and right ears. Good results may not be possible if there's too much reverb, so we recommend that you use this mode in an environment with little or no natural reverb.	<b>2.1</b> <b>3.1</b> <b>5.1</b> <b>7.1</b>			

### Note

- \*1 (North American models) This listening mode is not available.
  - \*2 When the input source contains the encoded front high channel, front high speakers output the sound.
  - \*3 If there are no surround back speakers, or Powered Zone 2 is being used, Dolby Pro Logic II is used.
  - \*4 Surround back speakers are not supported.
  - \*5 Front high speakers are not supported.
  - \*6 For the Blu-ray Discs, Dolby Digital is used in a 3.1/5.1-channel speaker system.
  - \*7 AV receiver can input the DSD signal from **HDMI IN**. Setting the output setting on the player side to PCM might obtain a better sound according to the player. In that case, set the output setting on the player side to PCM.
  - \*8 Depending on the input source, DTS is used.
  - \*9 If there are no surround back speakers, DTS is used.
  - \*10 Output can be switched between front high or surround back speakers by pressing **SP LAYOUT** [depending on the "Sp Config" setting (→ 36)].
- The listening modes cannot be selected with some source formats.

# Advanced Setup

## On-screen Setup Menus

The on-screen setup menus appear only on a TV that is connected to the HDMI OUT. If your TV is connected to the composite video MONITOR OUT or the COMPONENT VIDEO OUT, use the AV receiver's display when changing settings.

### Note

The on-screen setup menus are displayed when:

- There is no video input, or
- The video input is 480p, 576p, 720p, 1080i, or 1080p.

### Setup Menu

- |   |                  |         |
|---|------------------|---------|
| ① | 1. HDMI Input    | BD/DVD  |
| ② | 2. Component     | VCR/DVR |
| ③ | 3. Digital Audio | CBL/SAT |
| ④ | 4. Sp Config     | GAME    |
| ⑤ | 5. Sp Distance   | AUX     |
| ⑥ | 6. Level Cal     | TV/CD   |
| ⑦ | 7. Audio Adjust  | PORT    |
| ⑧ | 8. Name Edit     |         |
| ⑨ | 9. Hardware      |         |
| ⑩ | 10. HDMI Setup   |         |

#### ① HDMI Input (→ 35)

BD/DVD  
VCR/DVR  
CBL/SAT  
GAME  
AUX  
TV/CD  
PORT

#### ⑥ Level Cal (→ 37)

Left  
FrontHigh Left  
Center  
FrontHigh Right  
Right  
Surround Right  
SurrBack Right  
SurrBack Left  
Surround Left  
Subwoofer

#### ② Component (→ 35)

BD/DVD  
VCR/DVR  
CBL/SAT  
GAME  
AUX  
TV/CD  
PORT

#### ⑦ Audio Adjust (→ 37)

Input Ch(Mux)  
Input Ch(Mono)  
Panorama  
Dimension  
Center Width  
Height Gain  
Dolby EX  
Center Image  
Audysey  
Dynamic EQ  
Reference Leve  
Dynamic Volume  
Listening Angle

#### ③ Digital Audio (→ 35)

BD/DVD  
VCR/DVR  
CBL/SAT  
GAME  
AUX  
TV/CD  
PORT

#### ⑧ Name Edit (→ 40)

Name

#### ④ Sp Config (→ 36)

Subwoofer  
Front  
Center  
Surround  
Front High  
SurrBack  
SurrBack Ch  
Crossover  
Double Bass

#### ⑨ Hardware (→ 40)

Sp Impedance  
Speakers Type  
Front High/Zone2  
SurrBk/FrontHigh  
Remote ID  
FM/AM Freq Step  
SAT Radio  
Antenna Aiming  
Parental Lock

#### ⑤ Sp Distance (→ 37)

Unit  
Left  
FrontHigh Left  
Center  
FrontHigh Right  
Right  
Surround Right  
SurrBack Right  
SurrBack Left  
Surround Left  
Subwoofer

#### ⑩ HDMI Setup (→ 41)

Audio TV OUT  
LipSync  
HDMI Control  
Audio Return Ch  
Power Control  
TV Control

## Common Procedures in Setup Menu

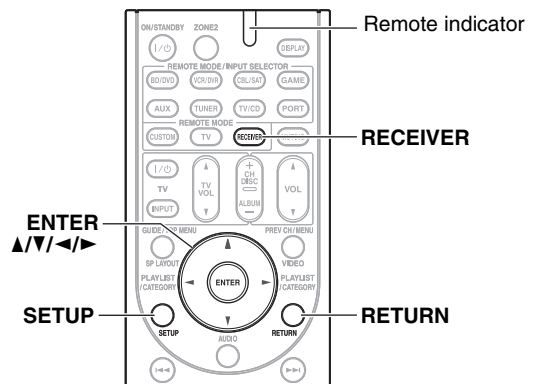

The on-screen setup menus appear on the connected TV and provide a convenient way to change the AV receiver's various settings. Settings are organized into ten categories on the **main menu**.

Carry out the settings by using the on-screen display.

### 1 Press RECEIVER followed by SETUP.

The following menu appears.

Setup Menu		
1. HDMI Input	BD/DVD	HDMI IN1
2. Component	VCR/DVR	HDMI IN2
3. Digital Audio	CBL/SAT	HDMI IN3
4. Sp Config	GAME	HDMI IN4
5. Sp Distance	AUX	-----
6. Level Cal	TV/CD	-----
7. Audio Adjust	PORT	-----
8. Name Edit		
9. Hardware		
10. HDMI Setup		

### Tip

- If the main menu doesn't appear, make sure the appropriate external input is selected on your TV.

### 2 Use ▲/▼ to select a menu, and then press ENTER.

### 3 Use ▲/▼ to select target, and ◀/▶ to change the setting.

Press **SETUP** to close the menu.

Press **RETURN** to return to the main menu.

### Note

- This procedure can also be performed on the AV receiver by using **SETUP**, arrow buttons, and **ENTER**.
- During Audyssey 2EQ® Room Correction and Speaker Setup, messages, etc., that are displayed on the TV screen will appear in the Display.

## Explanatory Notes

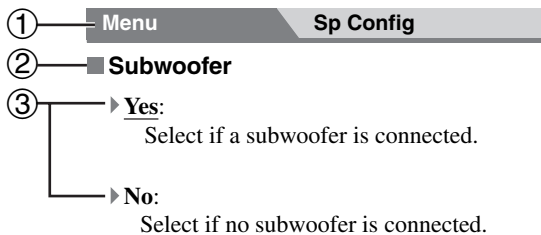

- ① Menu selection
- ② Setting target
- ③ Setting options (default setting underlined)

## HDMI Input

### Menu HDMI Input

If you connect a video component to an HDMI input, you must assign that input to an input selector. For example, if you connect your Blu-ray Disc/DVD player to **HDMI IN 2**, you must assign “**HDMI2**” to the “**BD/DVD**” input selector.

Here are the default assignments.

Input selector	Default assignment
BD/DVD	HDMI1
VCR/DVR	HDMI2
CBL/SAT	HDMI3
GAME	HDMI4
AUX	-----
TV/CD	-----
PORT	-----

### ■ BD/DVD, VCR/DVR, CBL/SAT, GAME, AUX, TV/CD, PORT

#### ▶ HDMI1, HDMI2, HDMI3, HDMI4:

Select a corresponding HDMI input that the video component has been connected.

#### ▶ -----:

Select if you're not using the **HDMI OUT**.

Each HDMI input cannot be assigned to two input selectors or more. When **HDMI1 - HDMI4** have already been assigned, you must set first any unused input selectors to “-----”, or you will be unable to assign **HDMI1 - HDMI4** to input selector.

#### Note

- When an **HDMI IN** is assigned to an input selector as explained here, the digital audio input for that input selector is automatically set to the same **HDMI IN** (→ 35, **Digital Audio (Digital Audio Input)**).
- If you connect a component (such as UP-A1 Dock that seated iPod) to **UNIVERSAL PORT** jack, you cannot assign any input to **PORT** selector.
- Do not assign the component connected with the HDMI input to **TV/CD** selector when you set “**TV Control**” setting to “**On**” (→ 42). Otherwise, appropriate CEC (Consumer Electronics Control) operation will not be guaranteed.

## Component (Component Video Input)

### Menu Component

If you connect a video component to a component video input, you must assign that input to an input selector. For example, if you connect your Blu-ray Disc/DVD player to **COMPONENT VIDEO IN 2**, you must assign “**IN2**” to the “**BD/DVD**” input selector.

Here are the default assignments.

Input selector	Default assignment
BD/DVD	IN1
VCR/DVR	-----
CBL/SAT	IN2
GAME	-----
AUX	-----
TV/CD	-----
PORT	-----

### ■ BD/DVD, VCR/DVR, CBL/SAT, GAME, AUX, TV/CD, PORT

#### ▶ IN1, IN2:

Select a corresponding component video input that the video component has been connected.

#### ▶ -----:

Select if you're not using the **COMPONENT VIDEO OUT**.

#### Note

- If you connect a component (such as UP-A1 Dock that seated iPod) to the **UNIVERSAL PORT** jack, you cannot assign any input to **PORT** selector.

## Digital Audio (Digital Audio Input)

### Menu Digital Audio

If you connect a component to a digital audio input, you must assign that input to an input selector. For example, if you connect your CD player to the **OPTICAL IN 1**, you must assign “**OPT1**” to the “**TV/CD**” input selector.

Here are the default assignments.

Input selector	Default assignment
BD/DVD	COAX1
VCR/DVR	-----
CBL/SAT	COAX2
GAME	OPT1
AUX	-----
TV/CD	OPT2
PORT	-----

### ■ BD/DVD, VCR/DVR, CBL/SAT, GAME, AUX, TV/CD, PORT

#### ▶ COAX1, COAX2, OPT1, OPT2:

Select a corresponding digital audio input that the component has been connected.

#### ▶ -----:

Select if the component is connected to an analog audio input.

### Note

- When an **HDMI IN** is assigned to an input selector in “HDMI Input” (→ **35**), this input assignment is automatically set to the same **HDMI IN**. And in addition to the usual inputs (e.g., **COAX1**, **COAX2**, etc.), you can also select HDMI inputs.
- Available sampling rate for PCM signals from a digital input (optical and coaxial) is 32/44.1/48/88.2/96 kHz/16, 20, 24 bit.
- If you connect a component (such as UP-A1 Dock that seated iPod) to the **UNIVERSAL PORT** jack, you cannot assign any input to **PORT** selector.

## Sp Config (Speaker Configuration)

### Menu

### Sp Config

Some of the settings in this section are set automatically by Audyssey 2EQ® Room Correction and Speaker Setup function (→ **23**).

Here you can check the settings made by Audyssey 2EQ Room Correction and Speaker Setup function, or set them manually, which is useful if you change one of the connected speakers after using Audyssey 2EQ Room Correction and Speaker Setup function.

This section explains how to specify which speakers are connected and their sizes.

For speakers with a cone diameter larger than 6-1/2 inches (16 cm), specify **Large** (full band). For those with a smaller diameter, specify **Small** (default crossover 100Hz).

The crossover frequency can be changed in the “Crossover (Crossover Frequency)” (→ **36**).

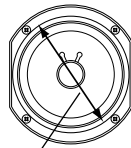

Cone diameter

### Note

These settings are disabled when:

- a pair of headphones is connected, or
- the “**Audio TV OUT**” setting is set to “**On**” (→ **41**) and an input selector other than HDMI is selected.

### Subwoofer

#### ▶ Yes:

Select if a subwoofer is connected.

#### ▶ No:

Select if no subwoofer is connected.

### Front

#### ▶ Small:

#### ▶ Large:

Select based on the cone diameter.

### Note

- If the “**Subwoofer**” setting is set to “**No**”, this setting is fixed at “**Large**” and does not appear.

### Center\*1, Surround\*1, Front High\*1\*2\*4\*5\*7\*8, SurrBack\*1\*2\*3\*4\*6\*8

#### ▶ Small:

#### ▶ Large:

Select based on the cone diameter.

#### ▶ None\*7:

Select if no speaker is connected.

### Note

- \*1 If the “**Front**” setting is set to “**Small**”, the “**Large**” option cannot be selected.
- \*2 If the “**Surround**” setting is set to “**None**”, this setting cannot be selected.
- \*3 If the “**SurrBk/FrontHigh**” setting is set to “**Front High**” (→ **40**), this setting cannot be selected.
- \*4 If the “**Speakers Type**” setting is set to “**Bi-AMP**” (→ **40**), this setting cannot be selected.
- \*5 If the “**Front High/Zone2**” setting is set to “**Zone2**” and “**SurrBk/FrontHigh**” setting is set to “**SurrBack**” (→ **40**), this setting cannot be selected.
- \*6 If the “**Surround**” setting is set to “**Small**”, the “**Large**” option cannot be selected.
- \*7 For “**Front High**”, the default is “**None**”.
- \*8 If the “**Front High/Zone2**” setting is set to “**Zone2**”, this setting cannot be selected.

### SurrBack Ch

#### ▶ 1ch:

Select if only one surround back speaker is connected.

#### ▶ 2ch:

Select if two (left and right) surround back speakers are connected.

### Note

- If the “**SurrBack**” setting is set to “**None**”, this setting cannot be selected.

### Crossover (Crossover Frequency)

This setting is advantageous for the speakers that you specified as “**Small**” in the “Sp Config (Speaker Configuration)” (→ **36**). To get the best bass performance from your speaker system, you need to set the crossover frequency according to the size and frequency response of your speakers.

▶ **40Hz, 50Hz, 60Hz, 80Hz, 100Hz, 120Hz, 150Hz, 200Hz:**

Use the diameter of the smallest speaker in your system when choosing the crossover frequency.

Speaker cone diameter	Crossover frequency
Over 8 in. (20 cm)	40/50/60 Hz*
6-1/2 to 8 in. (16 to 20 cm)	80 Hz
5-1/4 to 6-1/2 in. (13 to 16 cm)	100 Hz
3-1/2 to 5-1/4 in. (9 to 13 cm)	120 Hz
Under 3-1/2 in. (9 cm)	150/200 Hz*

- \* Choose the setting suitable for the speaker.

### Note

- For a more accurate setting, look up the frequency response in the manuals supplied with your speakers and set accordingly.
- Choose a higher crossover frequency if you want more sound from your subwoofer.

## ■ Double Bass

This setting is **not** set automatically by Audyssey 2EQ Room Correction and Speaker Setup function (→ 23).

### Note

- This function can be set only if the “**Subwoofer**” setting is set to “**Yes**”, and the “**Front**” setting is set to “**Large**” (→ 36).

With the Double Bass function, you can boost bass output by feeding bass sounds from the front left, right, and center channels to the subwoofer.

#### ▶ **On:**

Double Bass function on.

#### ▶ **Off:**

Double Bass function off.

## Sp Distance (Speaker Distance)

### Menu Sp Distance

This setting is set automatically by Audyssey 2EQ Room Correction and Speaker Setup function (→ 23).

Here you can specify the distance from each speaker to the listening position so that the sound from each speaker arrives at the listener’s ears as the sound designer intended.

## ■ Unit

### ▶ **feet:**

Distances can be set in feet. Range: **1ft** to **30ft** in 1 foot steps.

### ▶ **meters:**

Distances can be set in meters. Range: **0.3m** to **9.0m** in 0.3 meter steps.

(The default setting varies from country to country.)

## ■ Left, FrontHigh Left, Center, FrontHigh Right, Right, Surround Right, SurrBack Right, SurrBack Left, Surround Left, Subwoofer

- ▶ Specify the distance from the each speaker to your listening position.

### Note

- These settings are disabled when:
  - a pair of headphones is connected, or
  - the “**Audio TV OUT**” setting is set to “**On**” (→ 41) and an input selector other than HDMI is selected.
- Speakers that you set to “**No**” or “**None**” in the “Sp Config (Speaker Configuration)” (→ 36) cannot be selected.
- The Center, Right, Subwoofer and Front High distances can be set up to 5 ft. (1.5 m) more or less than the “**Left**” distance. For example, if the “**Left**” distance is set to 20 ft. (6 m), the Center, Right, Subwoofer, Front High Left and Front High Right distances can be set between 15 and 25 ft. (4.5 and 7.5 m).
- The Surround and Surround Back distances can be set up to 5 ft. (1.5 m) more or 15 ft. (4.5 m) less than the “**Left**” distance. For example, if the “**Left**” distance is set to 20 ft. (6 m), the Surr Right, Surr Left, Surr Back R and Surr Back L distances can be set between 5 and 25 ft. (1.5 and 7.5 m).

## Level Cal (Level Calibration)

### Menu Level Cal

This setting is set automatically by Audyssey 2EQ® Room Correction and Speaker Setup function. (→ 23)

Here you can adjust the level of each speaker with the built-in test tone so that the volume of each speaker is the same at the listening position.

## ■ Left, FrontHigh Left, Center\*1, FrontHigh Right, Right, Surround Right, SurrBack Right, SurrBack Left, Surround Left

- ▶ **-12 dB** to **0 dB** to **+12 dB** in 1 dB step.

## ■ Subwoofer\*1

- ▶ **-15 dB** to **0 dB** to **+12 dB** in 1 dB step.

### Note

- Speakers that you set to “**No**” or “**None**” in the “Sp Config (Speaker Configuration)” (→ 36) cannot be selected.
- The speakers cannot be calibrated while a pair of headphones is connected or the AV receiver is muted or “**Audio TV OUT**” setting is set to “**On**” (→ 41).

\*1 For the center speaker and subwoofer, the level settings made by using **AUDIO** are saved here as the default settings.

### Tip

- If you’re using a handheld sound level meter, adjust the level of each speaker so that it reads 75 dB SPL at the listening position, measured with C-weighting and slow reading.

## Audio Adjust

### Menu Audio Adjust

With the Audio Adjust functions and settings, you can adjust the sound and listening modes as you like.

## Multiplex/Mono Settings

### Multiplex

This setting determines which channel of a stereo multiplex source is output. Use it to select audio channels or languages with multiplex sources, multilingual TV broadcasts, and so on.

## ■ Input Ch(Mux)

### ▶ **Main:**

The main channel is output.

### ▶ **Sub:**

The sub channel is output.

### ▶ **M/S:**

Both the main and sub channels are output.

### Mono

This setting specifies the channel to be used for playing any 2-channel digital source such as Dolby Digital, or 2-channel analog/PCM source in the Mono listening mode.

## ■ Input Ch(Mono)

- ▶ **L+R:**  
Both the left and right channels are output.
- ▶ **Left:**  
Only the left channel is output.
- ▶ **Right:**  
Only the right channel is output.

## Dolby Settings

---

### PLIIx Music (2ch Input)

These settings apply to only 2-channel stereo sources. If you're not using any surround back speakers, these settings apply to Dolby Pro Logic II, not Dolby Pro Logic IIX.

### ■ Panorama

- ▶ **On:**  
Panorama function on.
- ▶ **Off:**  
Panorama function off.

With this setting, you can broaden the width of the front stereo image when using the Dolby Pro Logic IIX Music listening mode.

### ■ Dimension

- ▶ **-3 to 0 to +3**

With this setting, you can move the sound field forward or backward when using the Dolby Pro Logic IIX Music listening mode. Higher settings move the sound field backward. Lower settings move it forward.

If the stereo image feels too wide, or there's too much surround sound, move the sound field forward to improve the balance. Conversely, if the stereo image feels like it's in mono, or there's not enough surround sound, move it backward.

### ■ Center Width

- ▶ **0 to 3 to 7**

With this setting, you can adjust the width of the sound from the center speaker when using the Dolby Pro Logic IIX Music listening mode. Normally, if you're using a center speaker, the center channel sound is output by only the center speaker. (If you're not using a center speaker, the center channel sound will be distributed to the front left and right speakers to create a phantom center). This setting controls the front left, right, and center mix, allowing you to adjust the weight of the center channel sound.

### PLIIZ Height Gain

The Height Gain Control in Dolby Pro Logic IIZ enables the listener to select how much gain is applied to the front high speakers. There are three settings, "Low", "Mid" and "High", and the front high speakers are accentuated in that order. While "Mid" is the default listening setting, the listener may adjust the Height Gain Control to their personal preference.

## ■ Height Gain

- ▶ **Low:**  
Low PLIIZ Height Gain becomes active.
- ▶ **Mid:**  
Medium PLIIZ Height Gain becomes active.
- ▶ **High:**  
High PLIIZ Height Gain becomes active.

### Note

- If the "Front High" setting is set to "None" (→ 36), or "Front High/Zone2" setting is set to "Zone2" (→ 40), this setting is fixed at "Mid" and does not appear.

### Dolby EX

This setting determines how Dolby EX encoded signals are handled. This setting is unavailable if no surround back speakers are connected. This setting is effective with Dolby Digital, Dolby Digital Plus and Dolby TrueHD only.

### ■ Dolby EX

- ▶ **Auto:**  
If the source signal contains a Dolby EX flag, the Dolby EX listening mode is used.
- ▶ **Manual:**  
You can select any available listening mode.

### Note

- If the "SurrBack" Setting is set to "None" (→ 36), this setting cannot be selected.
- If the "Front High" setting is set to other than "None", this setting is fixed at "Manual" (→ 36).
- If the "Front High/Zone2" setting is set to "Zone2" (→ 40), this setting is fixed at "Manual" and does not appear.

## DTS Setting

---

### Neo:6 Music

### ■ Center Image

- ▶ **0 to 2 to 5**

The DTS Neo:6 Music listening mode creates 6-channel surround sound from 2-channel stereo sources. With this setting, you can specify by how much the front left and right channel output is attenuated in order to create the center channel.

Setting a value "0" in the middle is set to hear a sound. Sound is spread in left and right (the outside) so that the set value is made big. Please adjust by liking.

## Audyssey Settings

---

The tone for each speaker is set automatically by Audyssey 2EQ® Room Correction and Speaker Setup function. Be sure to select on after having performed the Room Correction and Speaker Setup (→ 23).

### ■ Audyssey

- ▶ **Off:**  
No Audyssey EQ equalizing will apply.
- ▶ **On:**  
"Dynamic EQ" and "Dynamic Volume" become available.  
The Audyssey indicator will light (→ 8).

#### Note

- Audyssey equalizing does not work for DSD sources.

### ■ Dynamic EQ

#### ▶ **Off:**

Audyssey Dynamic EQ off.

#### ▶ **On:**

Audyssey Dynamic EQ on.

The **Dynamic EQ** indicator will light (→ **8**).

With Audyssey Dynamic EQ™, you can enjoy great sound even when listening at low volume levels.

Audyssey Dynamic EQ solves the problem of deteriorating sound quality as volume is decreased by taking into account human perception and room acoustics. It does so by selecting the correct frequency response and surround volume levels moment-by-moment so that the content sounds the way it was created at any volume level — not just at reference level.

#### Note

- The setting is stored individually for each input selector.
- If Pure Audio (**European and Asian models**) or Direct listening mode is selected, this setting cannot be selected.

### ■ Reference Level

#### Dynamic EQ Reference Level Offset

#### ▶ **0 dB:**

It should be used when listening to movies.

#### ▶ **5 dB:**

Select this setting for content that has a very wide dynamic range, such as classical music.

#### ▶ **10 dB:**

Select this setting for jazz or other music that has a wider dynamic range. This setting should also be selected for TV content as that is usually mixed at 10 dB below film reference.

#### ▶ **15 dB:**

Select this setting for pop/rock music or other program material that is mixed at very high listening levels and has a compressed dynamic range.

Movies are mixed in rooms calibrated for film reference. To achieve the same reference level in a home theater system each speaker level must be adjusted so that -30 dBFS band-limited (500 Hz to 2000 Hz) pink noise produces 75 dB sound pressure level at the listening position. A home theater system automatically calibrated by Audyssey 2EQ will play at reference level when the master volume control is set to the 0 dB position. At that level you can hear the mix as the mixers heard it.

Audyssey Dynamic EQ is referenced to the standard film mix level. It makes adjustments to maintain the reference response and surround envelopment when the volume is turned down from 0 dB. However, film reference level is not always used in music or other non-film content. The Dynamic EQ Reference Level Offset provides three offsets from the film level reference (5 dB, 10 dB, and 15 dB) that can be selected when the mix level of the content is not within the standard.

#### Note

- If “**Dynamic EQ**” setting is set to “**Off**”, this setting cannot be selected.
- The setting is stored individually for each input selector.

### ■ Dynamic Volume

#### ▶ **Off:**

Audyssey Dynamic Volume™ off.

#### ▶ **Light:**

Light Compression Mode becomes active.

#### ▶ **Medium:**

Medium Compression Mode becomes active.

#### ▶ **Heavy:**

Heavy Compression Mode becomes active. This setting affects volume the most, causing all sounds to be of equal loudness.

#### Note

- If you make Dynamic Volume™ active, “**Audyssey**” and “**Dynamic EQ**” settings are set to “**On**”. The **Dynamic Vol** indicator will light (→ **8**).
- The setting is stored individually for each input selector.
- If Pure Audio (**European and Asian models**) or Direct listening mode is selected, this setting cannot be selected.

#### About Audyssey Dynamic EQ

Audyssey Dynamic EQ solves the problem of deteriorating sound quality as volume is decreased by taking into account human perception and room acoustics. Dynamic EQ selects the correct frequency response and surround levels moment-by-moment at any user-selected volume setting. The result is bass response, tonal balance, and surround impression that remain constant despite changes in volume. Dynamic EQ combines information from incoming source levels with actual output sound levels in the room, a prerequisite for delivering a loudness correction solution.

Audyssey Dynamic EQ works in tandem with Audyssey 2EQ to provide well-balanced sound for every listener at any volume level.

#### About Audyssey Dynamic Volume

Audyssey Dynamic Volume solves the problem of large variations in volume level between television programs, commercials, and between the soft and loud passages of movies. Dynamic Volume looks at the preferred volume setting by the user and then monitors how the volume of program material is being perceived by listeners in real time to decide whether an adjustment is needed. Whenever necessary, Dynamic Volume makes the necessary rapid or gradual adjustments to maintain the desired playback volume level while optimizing the dynamic range. Audyssey Dynamic EQ is integrated into Dynamic Volume so that as the playback volume is adjusted automatically, the perceived bass response, tonal balance, surround impression, and dialog clarity remain the same whether watching movies, flipping between television channels, or changing from stereo to surround sound content.

## Theater-Dimensional Setting

### ■ Listening Angle

#### ▶ **Wide:**

Select if the listening angle is 40 degrees.

#### ▶ **Narrow:**

Select if the listening angle is 20 degrees.

With this setting, you can optimize the Theater-Dimensional listening mode by specifying the angle of the front left and right speakers relative to the listening position. Ideally, the front left and right speakers should be equidistant from the listening position and at an angle close to one of the two available settings.

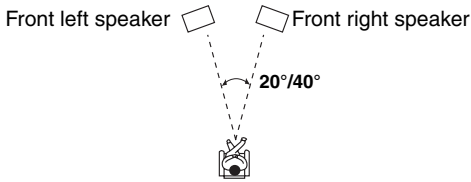

## Name Edit

Menu

Name Edit

You can enter a preset name for each individual input selector for easy identification. When entered, the preset name will appear on the display.

### Preparation

Press the input selector buttons to select an input source.

### ■ Name

▶ - - -, Blu-ray, DVD, HD DVD, VCR, DVR, Tivo, CableSTB, SAT STB, PS3, Wii, Xbox, PC, TV, CD, TAPE, iPod:

To reset to the default, select “- - -”.

#### Note

- Can not set the input selector by the same name.
- This menu cannot be used for the **TUNER** input selector.

## Hardware

Menu

Hardware

## Speaker Settings

**If you change these settings, you must run Audyssey 2EQ® Room Correction and Speaker Setup again (→ 23).**

If the impedance of any speaker is 4 ohms or more but less than 6, set the minimum speaker impedance to 4 ohms.

If you bi-amp the front speakers, you must change the “**Speakers Type**” setting.

For hookup information, see “Bi-amping the Front Speakers” (→ 13).

#### Note

- When bi-amping is used, the AV receiver is able to drive up to 5.1 speakers in the main room.
- Before you change these settings, turn down the volume.

### ■ Sp Impedance

#### ▶ **4ohms:**

Select if the impedance of any speaker is 4 ohms or more but less than 6.

#### ▶ **6ohms:**

Select if the impedances of all speakers are between 6 and 16 ohms.

#### Note

- (**North American models**) Do not support speakers with an impedance of less than 6 ohms.

### ■ Speakers Type

#### ▶ **Normal:**

Select this if you’ve connected your front speakers normally.

#### ▶ **Bi-AMP:**

Select this if you’ve bi-amped your front speakers.

### ■ Front High/Zone2

#### ▶ **Front High:**

Front high speakers can be used.

#### ▶ **Zone2:**

Zone2 speakers can be used.

Select “**Zone2**” if you’ve connected your Zone 2 speakers to **FRONT HIGH OR ZONE 2 SPEAKERS L/R** terminals (→ 46).

#### Note

- If the “**Speakers Type**” setting is set to “**Bi-AMP**”, this setting cannot be selected.

### ■ SurrBk/FrontHigh

#### ▶ **Front High:**

Front high speakers can be used.

#### ▶ **SurrBack:**

Surround back speakers can be used.

Select “**Front High**” if you’ve connected your Zone 2 speakers to **FRONT HIGH OR ZONE 2 SPEAKERS L/R** terminals, and the front high speakers to **SURR BACK OR FRONT HIGH SPEAKERS L/R** terminals.

#### Note

- If the “**Front High/Zone2**” setting is set to “**Front High**”, this setting is set to “**SurrBack**”.
- If the “**Speakers Type**” setting is set to “**Bi-AMP**”, this setting cannot be selected.



## Remote Control Settings

### ■ Remote ID

- ▶ 1, 2, or 3

When several Onkyo components are used in the same room, their remote ID codes may overlap. To differentiate the AV receiver from the other components, you can change its remote ID from “1”, to “2” or “3”.

#### Note

- If you do change the AV receiver’s remote ID, be sure to change the remote controller to the same ID (see below), otherwise, you won’t be able to control it with the remote controller.

### Changing the Remote Controller’s ID

- 1** While holding down **RECEIVER**, press and hold down **SETUP** until the remote indicator lights (about 3 seconds) (→ 34).
- 2** Use the number buttons to enter **ID 1, 2, or 3**. The remote indicator flashes twice.

## FM/AM Frequency Setup Settings

For FM/AM tuning to work properly, you must specify the FM/AM frequency step used in your area. Note that when this setting is changed, all radio presets will be deleted.

### ■ FM/AM Freq Step (North American models)

- ▶ **200k/10kHz:**  
Select if 200k/10kHz steps are used in your area.
- ▶ **50k/9kHz:**  
Select if 50k/9kHz steps are used in your area.

### ■ AM Freq Step (European and Asian models)

- ▶ **10kHz:**  
Select if 10kHz steps are used in your area.
- ▶ **9kHz:**  
Select if 9kHz steps are used in your area.

## SIRIUS Settings (North American models)

See the separate Satellite Radio Guide for more information.

### ■ SAT Radio

If you connect a SIRIUS Satellite Radio antenna to the AV receiver (sold separately), set this setting to “**SIRIUS**”.

### ■ Antenna Aiming

### ■ Parental Lock

These items are for use with SIRIUS Satellite Radio. It’s not available if “**SAT Radio**” is set to “**None**”.

## HDMI Setup

Menu

HDMI Setup

### ■ Audio TV OUT

- ▶ **Off:**  
HDMI audio is not output.
- ▶ **On:**  
HDMI audio is output.

This preference determines whether audio received at the **HDMI IN** is output by the **HDMI OUT**. You may want to turn this preference on if your TV is connected to the **HDMI OUT** and you want to listen to the audio from a component that’s connected to an **HDMI IN**, through your TV’s speakers. Normally, this should be set to “**Off**”.

#### Note

- If “**On**” is selected and the signal can be output by the TV, the AV receiver will output no sound through its speakers.
- If “**On**” is selected, “**TV Sp On**” appears on the display by pressing **DISPLAY**.
- When “**TV Control**” is set to “**On**”, this setting is fixed to “**Auto**”.
- With some TVs and input signals, no sound may be output even when this setting is set to “**On**”.
- When the “**Audio TV OUT**” setting is set to “**On**”, or “**TV Control**” is set to “**On**” and you’re listening through your TV’s speakers (→ 15), if you turn up the AV receiver’s volume control, the sound will be output by the AV receiver’s front left and right speakers. To stop the AV receiver’s speakers producing sound, change the settings, change your TV’s settings, or turn down the AV receiver’s volume.

### ■ LipSync

- ▶ **Disable:**  
HDMI lip sync disabled.
- ▶ **Enable:**  
HDMI lip sync enabled.

The AV receiver can be set to automatically correct any delay between the video and the audio, based on the data from the connected monitor.

#### Note

- This function works only if your HDMI-compatible TV supports HDMI Lip Sync.
- You can check the amount of delay being applied by the HDMI Lip Sync function on the A/V Sync screen.

## ■ HDMI Control (RIHD)

### ▶ Off:

**RIHD** disabled.

### ▶ On:

**RIHD** enabled.

This function allows **RIHD**-compatible components connected via HDMI to be controlled with the AV receiver (→ 15).

### Note

- When set to “**On**” and close the menu, the name of connected **RIHD**-compatible components and “**RIHD On**” are displayed on the AV receiver.  
“**Search...**” → “(name)” → “**RIHD On**”  
When the AV receiver cannot receive the name of the component, it is displayed as “**Player\***” or “**Recorder\***”, etc (“\*” means the number of two or more component).  
When set to “**Off**” and close the menu, “**RIHD Off**” are displayed on the AV receiver.  
“**Disconnect**” → “**RIHD Off**”
- When an **RIHD**-compatible component is connected to the AV receiver via the HDMI cable, the name of the connected component is displayed on the AV receiver display. For example, while you are watching TV broadcasting, if you operate a Blu-ray Disc/DVD player (being powered on) by the remote control of the AV receiver, the name of the Blu-ray Disc/DVD player is displayed on the AV receiver.
- Set to “**Off**” when a connected piece of equipment is not compatible or it is unclear whether the equipment is compatible or not.
- If movement is unnatural when set to “**On**”, change the setting to “**Off**”.
- Refer to the connected component’s instruction manual for details.

## ■ Audio Return Ch (ARC)

### ▶ Off:

Select “**Off**” if you don’t want to use audio return channel (ARC) function.

### ▶ Auto:

The audio signal from your TV tuner can be sent digitally to the **HDMI OUT** of the AV receiver.

Audio return channel (ARC) function enables an HDMI 1.4 capable TV to send the audio stream to the **HDMI OUT** of the AV receiver. To use this function, you must select the **TV/CD** input selector and your TV must support ARC function.

### Note

- The “**Audio Return Ch**” setting can be set only when the above “**HDMI Control**” setting is set to “**On**”.
- This setting is set to “**Auto**” automatically when the above “**HDMI Control**” is set to “**On**” first time.

## ■ Power Control

### ▶ Off:

Power Control disabled.

### ▶ On:

Power Control enabled.

To link the power functions of **RIHD**-compatible components connected via HDMI, select “**On**”.

This setting is set to “**On**” automatically when the above “**HDMI Control**” is set to “**On**” first time.

### Note

- The “**Power Control**” setting can be set only when the above “**HDMI Control**” setting is set to “**On**”.
- HDMI power control only works with **RIHD**-compatible components that support it and may not work properly with some components due to their settings or compatibility.
- When set to “**On**”, power consumption will increase.
- When set to “**On**”, regardless of whether the AV receiver is **On** or in Standby, both audio and video stream from an HDMI input will be output to the TV or other components via HDMI connection (HDMI pass through function). When the HDMI pass through function activates in standby mode, **HDMI THRU** indicator will light.
- The power consumption during standby mode will increase during the HDMI pass through function; however in the following cases, the power consumption can be saved:
  1. The TV is in standby mode.
  2. You are watching a TV program.
- Refer to the connected component’s instruction manual for details.

## ■ TV Control

### ▶ Off:

TV Control disabled.

### ▶ On:

TV Control enabled.

Set to “**On**” when you want to control the AV receiver from an **RIHD**-compatible TV that is connected to HDMI.

### Note

- Do not assign the component connected with the HDMI input to the **TV/CD** selector when you set “**TV Control**” setting to “**On**”. Otherwise, appropriate CEC (Consumer Electronics Control) operation is not guaranteed.
- Set to “**Off**” when the TV is not compatible or when it is unclear whether the TV is compatible or not.
- The “**TV Control**” setting can be set only when the above “**HDMI Control**” and “**Power Control**” settings are both set to “**On**”.
- Refer to the connected component’s instruction manual for details.

After changing the settings of the “**HDMI Control**”, “**Audio Return Ch**”, “**Power Control**”, or “**TV Control**”, turn off the power to all connected pieces of equipment and then turn them on again. Refer to the User’s Manuals for all connected pieces of equipment.

## Using the Audio Settings

You can change various audio settings by pressing **AUDIO**.

### Note

These settings are disabled when:

- a pair of headphones is connected, or
- the “**Audio TV OUT**” setting is set to “**On**” (→ 41) and an input selector other than HDMI is selected.

### 1 Press **RECEIVER** followed by **AUDIO**.

### 2 Use **▲/▼** to select an item, and **◀/▶** to change the setting.

Repeat this step for the other settings.

## Tone Control Settings

You can adjust the bass and treble for the front speakers, except when the Direct or Pure Audio listening mode is selected.

### ■ Bass

- ▶ **-10 dB** to **0 dB** to **+10 dB** in 2 dB steps  
You can boost or cut low-frequency sounds output by the front speakers.

### ■ Treble

- ▶ **-10 dB** to **0 dB** to **+10 dB** in 2 dB steps  
You can boost or cut high-frequency sounds output by the front speakers.

### Note

- To bypass the bass and treble tone circuits, select the Direct or Pure Audio listening mode.
- This procedure can also be performed on the AV receiver by using its **TONE**, **-**, and **+** buttons (→ 45).

## Speaker Levels

You can adjust the volume of each speaker while listening to an input source.

These temporary adjustments are cancelled when the AV receiver is set to Standby. To save the setting you made here, go to “**Level Cal (Level Calibration)**” (→ 37) before setting the AV receiver to Standby.

### ■ Subwoofer

- ▶ **-15 dB** to **0 dB** to **+12 dB** in 1 dB steps

### ■ Center

- ▶ **-12 dB** to **0 dB** to **+12 dB** in 1 dB steps

### Note

- You cannot use this function while the AV receiver is muted.
- Speakers that are set to “**No**” or “**None**” in the “**Sp Config (Speaker Configuration)**” (→ 36) cannot be adjusted.

## Audyssey Settings

### ■ Dynamic EQ

### ■ Dyn Vol (Dynamic Volume)

See “**Dynamic EQ**” and “**Dynamic Volume**” of “**Audio Adjust**” (→ 38).

## Late Night Function

With the Late Night function, you can reduce the dynamic range of Dolby Digital material so that you can still hear quiet parts even when listening at low volume levels—ideal for watching movies late at night when you don’t want to disturb anyone.

### ■ Late Night

For **Dolby Digital** and **Dolby Digital Plus** sources, the options are:

- ▶ **Off:**  
Late Night function off.
- ▶ **Low:**  
Small reduction in dynamic range.
- ▶ **High:**  
Large reduction in dynamic range.

For **Dolby TrueHD** sources, the options are:

- ▶ **Auto:**  
The Late Night function is set to “**On**” or “**Off**” automatically.
- ▶ **Off:**  
Late Night function off.
- ▶ **On:**  
Late Night function on.

### Note

- The effect of the Late Night function depends on the material that you are playing and the intention of the original sound designer, and with some material there will be little or no effect when you select the different options.
- The Late Night function can be used only when the input source is Dolby Digital, Dolby Digital Plus, or Dolby TrueHD.
- The Late Night function is set to “**Off**” when the AV receiver is set to Standby. For Dolby TrueHD sources, it will be set to “**Auto**”.

## Music Optimizer

The Music Optimizer function enhances the sound quality of compressed music files. Use it with music files that use “**lossy**” compression, such as MP3.

### ■ M.Optimizer

- ▶ **Off:**  
Music Optimizer off.
- ▶ **On:**  
Music Optimizer on.

### Note

- The Music Optimizer function only works with PCM digital audio input signals with a sampling rate below 48 kHz and analog audio input signals. The Music Optimizer is disabled when the Direct or Pure Audio listening mode is selected.
- The setting is stored individually for each input selector.
- The **M.Opt** indicator will light (→ 8).

## CinemaFILTER

---

With the CinemaFILTER, you can soften overly bright movie soundtracks, which are typically mixed for reproduction in a movie theater.

CinemaFILTER can be used with the following listening modes: Dolby Digital, Dolby Digital EX, Dolby Digital Plus, TrueHD, Dolby Pro Logic IIx Movie, Dolby Pro Logic II Movie, Dolby Pro Logic IIz Height, Multichannel, DTS, DTS-ES, DTS Neo:6 Cinema, DTS 96/24, Neo:6, DTS-HD High Resolution, DTS-HD Master and DTS Express.

### ■ Cinema Fltr

#### ▶ Off:

CinemaFILTER off.

#### ▶ On:

CinemaFILTER on.

### Note

- The CinemaFILTER may not work when used with certain input sources.

## Audio Selector

---

You can set priorities of audio output when there are both digital and analog inputs.

### ■ AudioSel

#### ▶ ARC:

The audio signal from your TV tuner can be sent digitally to the **HDMI OUT** of the AV receiver.\*1  
With this selection the TV's audio can be automatically selected as a priority among other assignments.

#### ▶ HDMI:

This can be selected when **HDMI IN** has been assigned as an input source. If both HDMI (**HDMI IN**) and digital audio inputs (**COAXIAL IN** or **OPTICAL IN**) have been assigned, HDMI input is automatically selected as a priority.

#### ▶ COAX:

This can be selected when **COAXIAL IN** has been assigned as an input source. If both coaxial and optical inputs have been assigned, coaxial input is automatically selected as a priority.

#### ▶ OPT:

This can be selected when **OPTICAL IN** has been assigned as an input source.

#### ▶ Analog:

The AV receiver always outputs analog signals.

### Note

- The setting is stored individually for each input selector.
- This setting can be made only for the input source that is assigned as **HDMI IN**, **COAXIAL IN**, or **OPTICAL IN**. If both HDMI (**HDMI IN**) and digital audio inputs (**COAXIAL IN** or **OPTICAL IN**) are assigned, HDMI input will be selected as a priority by setting to "ARC" (→ 42). To select the digital audio input, see "Digital Audio (Digital Audio Input)" (→ 35).

\*1 You can select "ARC" if you select the **TV/CD** input selector.  
But you cannot select it if you've selected "Off" in the "Audio Return Ch" setting (→ 42).

## A/V Sync

---

When using progressive scanning on your Blu-ray Disc/DVD player, you may find that the picture and sound are out of sync. With this setting, you can correct this by delaying the audio signals.

### ■ A/V Sync

▶ 0 ms to 100 ms in 10 ms steps

### Note

- A/V Sync is disabled when the Pure Audio or Direct listening mode is used with an analog input source.
- The setting is stored individually for each input selector.

## Digital Input Signal Formats

The digital input signal formats are available only for the input sources that you have assigned a digital input jack (→ 35).

Normally, the AV receiver detects the signal format automatically. However, if you experience either of the following issues when playing PCM or DTS material, you can manually set the signal format to PCM or DTS.

### Note

- If the beginnings of tracks from a PCM source are cut off, try setting the format to PCM.
- If noise is produced when fast forwarding or reversing a DTS CD, try setting the format to DTS.
- The setting is stored individually for each input selector.
- The setting will be reset to “Auto” when you change the setting in the “Audio Selector” (→ 44).

**1** Press **RECEIVER**, and then press and hold **AUDIO** for about 8 seconds.

**2** While “Auto” lights (about 3 seconds), press ◀/▶ to select:

▶ **Auto:**

The format is detected automatically. If no digital input signal is present, the corresponding analog input is used instead.

▶ **PCM:**

Only 2-channel PCM format input signals will be heard. If the input signal is not PCM, the PCM indicator will flash and noise may also be produced.

▶ **DTS:**

Only DTS (but not DTS-HD) format input signals will be heard. If the input signal is not DTS, the DTS indicator will flash and there will be no sound.

## Adjusting the Bass & Treble

You can adjust the bass and treble for the front speakers, except when the Direct, Pure Audio listening mode is selected.

**1** Press **TONE** on the AV receiver repeatedly to select either “Bass” or “Treble”.

**2** Use **TONE +/-** on the AV receiver to adjust.

### ■ Bass

### ■ Treble

See “Bass” and “Treble” of “Tone Control Settings” (→ 43).

### Note

- To bypass the bass and treble tone circuits, select the Direct or Pure Audio listening mode.
- This procedure can also be performed on the remote controller by using **AUDIO** (→ 43).

# Zone 2

In addition to your main listening room, you can also enjoy playback in the other room, or as we call Zone 2. And, you can select a different source for each room.

## Connecting Zone 2

There are two ways you can connect Zone 2 speakers:

1. Connect them directly to the AV receiver.
2. Connect them to an amp in Zone 2.

### Connecting Your Zone 2 Speakers Directly to the AV receiver

This setup allows 5.1-channel playback in your main room and 2-channel stereo playback in Zone 2, with a different source in each room. This is called Powered Zone 2, as the Zone 2 speakers are powered by the AV receiver. Note that when Powered Zone 2 is turned off, you can enjoy 7.1-channel playback in your main room.

To use this setup, you must set the “Front High/Zone2” setting to “Zone2” (→ 47).

#### Hookup

- Connect your Zone 2 speakers to the AV receiver’s **FRONT HIGH OR ZONE2 L/R** speaker terminals.

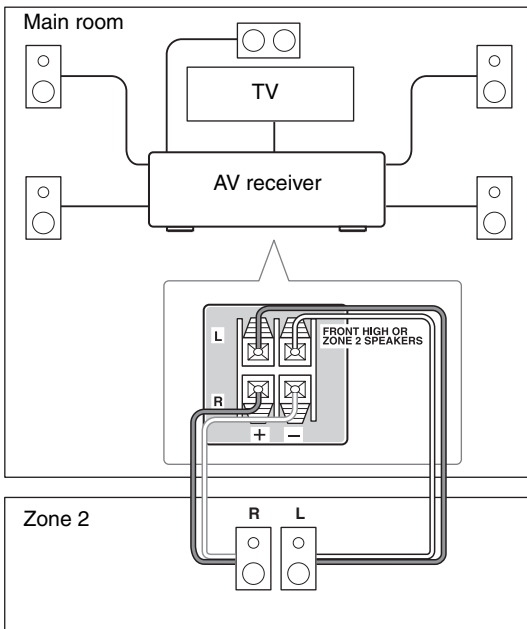

#### Note

- With this setup, the Zone 2 volume is controlled by the AV receiver.
- Powered Zone 2 cannot be used if “Speakers Type” is set to “Bi-AMP” (→ 40).

### Connecting Your Zone 2 Speakers to an Amp in Zone 2

This setup allows 7.1-channel playback in your main listening room and 2-channel stereo playback in Zone 2, with a different source in each room.

#### Hookup

- Use an RCA audio cable to connect the AV receiver’s **ZONE 2 LINE OUT L/R** jacks to an analog audio input on your Zone 2 amp.
- Connect your Zone 2 speakers to the speaker terminals on your Zone 2 amp.

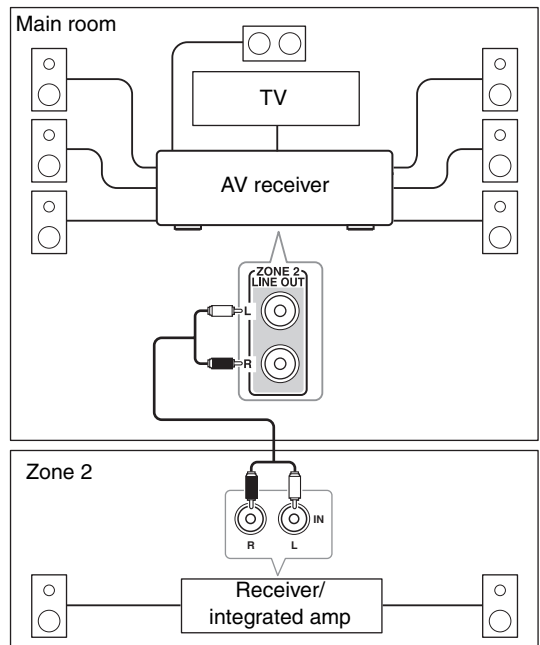

#### Note

- The Zone 2 volume must be set on the Zone 2 amp.

## Setting the Powered Zone 2

If you've connected your Zone 2 speakers to the AV receiver, as explained in "Connecting Your Zone 2 Speakers Directly to the AV receiver" (→ 46), you must set the "Front High/Zone2" setting to "Zone2".

Menu	Hardware
<b>1</b>	Press <b>RECEIVER</b> followed by <b>SETUP</b> . The setup menu appears.
<b>2</b>	Use <b>▲/▼</b> to select "Hardware", and then press <b>ENTER</b> .
<b>3</b>	Use <b>▲/▼</b> to select "FrontHigh/Zone2", and <b>◀/▶</b> to select "Zone2". ▶ <b>Zone2:</b> <b>FRONT HIGH OR ZONE2 L/R</b> speaker terminals activated (Powered Zone 2 enabled).

### Note

- When "Zone2" is selected and Zone 2 turned on, the Zone 2 speakers connected to the **FRONT HIGH OR ZONE2 L/R** speaker terminals output sound, but the surround back or front high speakers connected to the **SURR BACK OR FRONT HIGH L/R** speaker terminals do not. When "Zone2" is selected and Zone 2 turned off, the surround back or front high speakers output sound as normal.
- When the "Front High/Zone2" setting is set to "Zone2" and the input selector of Zone 2 is selected, power consumption on standby mode slightly increases.
- Powered Zone 2 cannot be used if "Speakers Type" is set to "Bi-AMP" (→ 40).

## Using Zone 2

This section explains how to turn Zone 2 on and off, how to select an input source for Zone 2, and how to adjust the volume for Zone 2.

### Controlling Zone 2 from the AV receiver

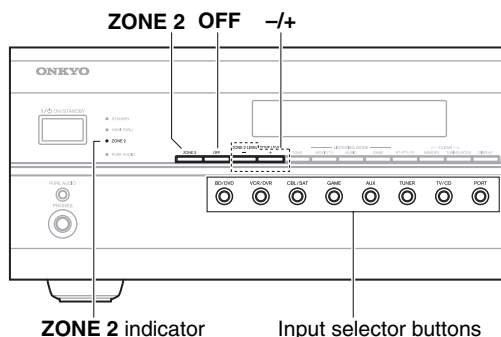

- 1** To turn on Zone 2 and select an input source, press **ZONE 2** on the AV receiver followed by an input selector button within 8 seconds.

Zone 2 turns on, the **ZONE 2** indicator lights.

To select AM or FM press the **TUNER** input selector button repeatedly.

(North American models) You can also select SIR-IUS.

To select the same source as that of the main room, press **ZONE 2** repeatedly until "**Z2 Selector: Source**" appears on the display.

### Note

- You cannot select different AM or FM radio stations for your main room and Zone 2. The same FM/AM radio station will be heard in each room.

- 2** To turn off Zone 2, press **OFF** on the AV receiver.

### Note

- While Powered Zone 2 is being used, listening modes that require surround back and front high speakers (6.1/7.1), such as Dolby Pro Logic IIz Height, Dolby Digital EX, and DTS-ES are unavailable.
- When the "Front High/Zone2" setting is set to "Zone2" and the input selector of Zone 2 is selected, power consumption on standby mode slightly increases.

## Controlling Zone 2 with the Remote Controller

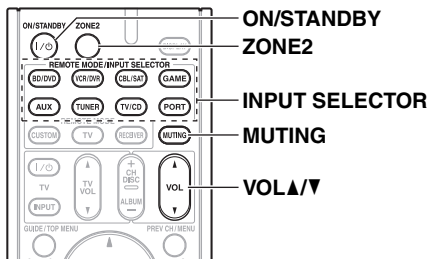

**1** Press **ZONE2**, and then press **ON/STANDBY**.  
Zone 2 turns on, the **ZONE 2** indicator lights.

**2** To select an input source for Zone 2, press **ZONE2**, followed by an **INPUT SELECTOR**.  
To select AM or FM press the **TUNER** input selector repeatedly.  
(North American models) You can also select **SIR-IUS**.

### Note

- You cannot select different AM or FM radio stations for your main room and Zone 2. The same FM/AM radio station will be heard in each room.

**3** To turn off Zone 2, press **ZONE2** followed by **ON/STANDBY**.

### Note

- To control Zone 2, you must press the remote controller's **ZONE2** first.

## Adjusting the Volume for Zone 2

### ■ Operating with the remote controller

**1** Press **ZONE2**

**2** Use **VOL ▲/▼**

### ■ Operating on the AV receiver

**1** Press **ZONE 2** (the **ZONE 2** indicator and **Zone 2** selector on the display flashes)

**2** Use **-/+** within 8 seconds

If your Zone 2 speakers are connected to a receiver or integrated amp in Zone 2, use its volume control to adjust the volume.

## Muting Zones

### ■ Operating with the remote controller

**1** Press **ZONE2**

**2** Press **MUTING**

To unmute a zone

**1** Press **ZONE2**

**2** Press **MUTING** again

### Note







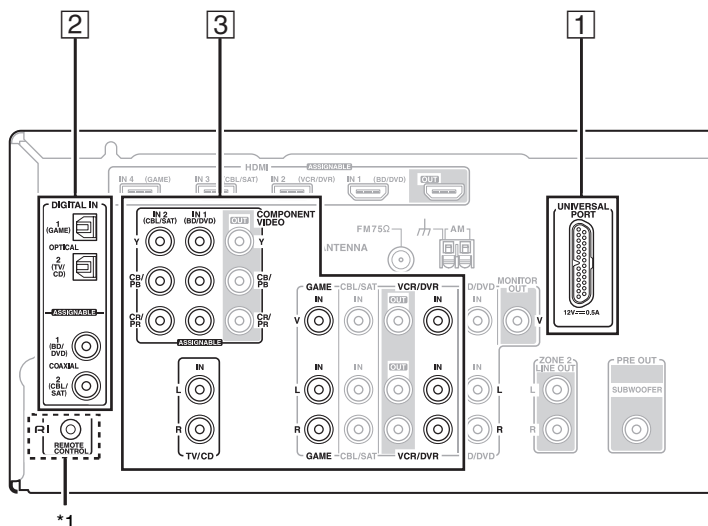

- Only analog input sources are output by the **ZONE 2 LINE OUT** and **FRONT HIGH OR ZONE2 L/R** speaker terminals. Digital input sources are not output. If no sound is heard when an input source is selected, check if it's connected to an analog input.
- While Powered Zone 2 is being used, listening modes that require surround back and front high speakers (6.1/7.1), such as Dolby Pro Logic IIz Height, Dolby Digital EX, and DTS-ES are unavailable.
- While Zone 2 is on, **RI** functions will not work.
- You cannot select different AM or FM radio stations for your main room and Zone 2. The same FM/AM radio station will be heard in each room. For example, if you have an FM station for the main room, that station will also be used in Zone 2.
- Zones can also be unmuted by adjusting the volume.

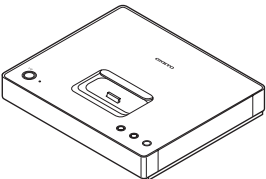

# Controlling iPod

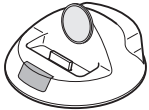
## Connecting an Onkyo Dock

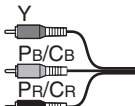

No.	Onkyo Dock	Cable	Note	Page
1	UP-A1 Dock (Universal Port Option Dock) 	—	<ul style="list-style-type: none"> <li>When UP-A1 Dock that seated iPod is connected, the power consumption on standby mode slightly increases.</li> <li>You can control your iPod when “PORT” is selected as the input source.</li> <li>See the UP-A1 Dock’s instruction manual for more information.</li> </ul>	(→ 50)
2	ND-S1 	Optical digital audio  Coaxial digital audio  RI cable  *1	<ul style="list-style-type: none"> <li>See the ND-S1’s instruction manual for more information.</li> <li>*1 The ND-S1’s audio outputs are digital outputs. If the digital audio input on your AV receiver cannot be assigned to an input selector whose Input Display can be set to “DOCK”, do not connect the RI cable, otherwise a malfunction may occur.</li> </ul>	(→ 50)
3	RI Dock  	Analog audio (RCA)  Component video  Composite video  RI cable  *1	<ul style="list-style-type: none"> <li>See the RI Dock’s instruction manual for more information.</li> <li>*1 To use RI (Remote Interactive), you must make an analog audio connection (RCA) between the AV receiver and the RI Dock.</li> </ul>	(→ 51)

Models sold are different depending on the region.

## Using the Onkyo Dock

Dock is sold separately.

For the latest information on the Onkyo Dock components, see the Onkyo web site at:  
<http://www.onkyo.com>

Before using the Onkyo Dock components, update your iPod with the latest software, available from the Apple web site.

For supported iPod models, see the instruction manual of the Onkyo Dock.

### UP-A1 Dock

With the UP-A1 Dock, you can easily play the music, photo, or movie stored on your Apple iPod through the AV receiver and enjoy great sound.

You can use the AV receiver's remote controller to operate your iPod.

#### Basic Operation

The AV receiver may take several seconds to startup, so you might not hear the first few seconds of the first song.

#### Auto Power On

If you start iPod playback while the AV receiver is on Standby, the AV receiver will automatically turn on and select your iPod as the input source.

#### Direct Change

If you start iPod playback while listening to another input source, the AV receiver will automatically select your iPod as the input source.

#### Using the AV receiver's Remote Controller

You can use the AV receiver's remote controller to control basic iPod functions (→ 51).

#### Operating Notes

- Functionality depends on your iPod model and generation.
- Before selecting a different input source, stop iPod playback to prevent the AV receiver from selecting the iPod input source by mistake.
- If any accessories are connected to your iPod, the AV receiver may not be able to select the input source properly.
- When connecting UP-A1 Dock to the radio tuner UP-HT1 (North American models)/UP-DT1 (European and Asian models) with AUTO selected by the tuner's Mode Selector switch, you can switch the input source between UP-A1 Dock and the tuner, by pressing **PORT** repeatedly on the front panel.
- While your iPod is in the UP-A1 Dock, its volume control has no effect. If you adjust your iPod models volume control while it's in the UP-A1 Dock, make sure it's not set too high before you reconnect your headphones.
- The Auto Power On function will not work if you set your iPod in the UP-A1 Dock while it is playing.
- When Zone 2 is turned on, you can't use Auto Power On and Direct Change functions.
- Do not turn off the power with the iPod still connected to this unit via the UP-A1 Dock.
- Set your iPod in the UP-A1 Dock after the AV receiver turns on.

#### Using Your iPod models Alarm Clock

You can use your iPod models Alarm Clock function to automatically turn on your iPod and the AV receiver at a specified time. The AV receiver's input source will automatically be set to the **PORT** selector.

#### Note

- To use this function, your iPod must be in the UP-A1 Dock, and the UP-A1 Dock must be connected to the AV receiver.
- This function only works when the Standard mode is set to **On**.
- When you use this function, be sure to set the AV receiver's volume control to a suitable level.
- When Zone 2 is turned on, you can't use this function.
- You cannot use this function for sound effects on your iPod.

#### Charging Your iPod models Battery

The UP-A1 Dock charges your iPod models battery while your iPod is in the UP-A1 Dock and connected to the **UNIVERSAL PORT** jack on the AV receiver. While your iPod is seated in the UP-A1 Dock, its battery will be charged when the AV receiver is set to "On" or "Standby".

#### Note

- When UP-A1 Dock that seated iPod is connected, the power consumption on standby mode slightly increases.

#### Status Messages

##### PORT Reading

The AV receiver is checking the connection with the dock.

##### PORT Not Support

The AV receiver do not support the connected dock.

##### PORT UP-A1

UP-A1 Dock is connected.

#### Note

- The AV receiver displays the message "**UP-A1**" for several seconds after recognizing the UP-A1.
- When the status message is not displayed on the AV receiver's display, check the connection to your iPod.

### ND-S1

With the ND-S1 Digital Media Transport, you can easily play the music stored on your iPod through the AV receiver and enjoy great sound.

The ND-S1 processes the digital audio signal directly from your iPod for high-quality digital audio output (optical or coaxial).

#### Note

- Set the ND-S1 iPod/PC Mode to "iPod".
- Set the AV receiver's Input Display to "**DOCK**" (→ 22).

## RI Dock

---

With the RI Dock, you can easily play the music stored on your Apple iPod through the AV receiver and enjoy great sound, and watch iPod slideshows and videos on your TV. In addition, the onscreen display (OSD) allows you to view, navigate, and select your iPod's contents on your TV, and with the supplied remote controller, you can control your iPod from the comfort of your sofa. You can even use the AV receiver's remote controller to operate your iPod.

### Note

- Enter the appropriate remote control code before using the AV receiver's remote controller for the first time (→ 53).
- Connect the RI Dock to the AV receiver with an **RI** cable (→ 49).
- Set the RI Dock's RI MODE switch to "**HDD**" or "**HDD/DOCK**".
- Set the AV receiver's Input Display to "**DOCK**" (→ 22).

## System Function

### System On

When you turn on the AV receiver, the ND-S1, RI Dock and iPod turn on automatically. In addition, when the ND-S1, RI Dock and iPod are on, the AV receiver can be turned on by pressing **ON/STANDBY**.

### Auto Power On

If you press the remote controller's ► while the AV receiver is on Standby, the AV receiver will automatically turn on, select your iPod as the input source, and your iPod will start playback.

### Direct Change

If you start iPod playback while listening to another input source, the AV receiver will automatically switch to the input to which the ND-S1 and RI Dock is connected.

### Other Remote Controllers

You can use the remote controller that came with the AV receiver to control other iPod functions. The available functionality depends on the AV receiver.

### iPod Alarm

If you use the Alarm function on your iPod to start playback, the AV receiver will turn on at the specified time and select your iPod as the input source automatically.

### Note

- Linked operations do not work with video playback or when the alarm is set to play a sound.
- If you use your iPod with any other accessories, iPod playback detection may not work.
- This function only works when the Standard mode is set to **On**.

## Operating Notes

- Use the AV receiver's volume control to adjust the playback volume.
- While your iPod is inserted in the ND-S1 and RI Dock, its volume control has no effect.
- If you do adjust the volume control on your iPod while it's inserted in the ND-S1 and RI Dock, be careful that it's not set too loud before you reconnect your earphones.

### Note

- On the 5th generation iPod and iPod nano, the click wheel is disabled during playback. For ND-S1, use **iPod** to start and stop playback and the remote controller to control other iPod functions.

## Controlling Your iPod

By pressing **REMOTE MODE** that's been programmed with the remote control code for your Dock, you can control your iPod in the Dock with the following buttons. See "Entering Remote Control Codes" for details on entering a remote control code (→ 53).

See the Dock's instruction manual for more information.

### UP-A1 Dock

**PORT** is preprogrammed with the remote control code for controlling a Dock with Universal Port connector.

You can control your iPod when "**PORT**" is selected as the input source.

## Without the RI Control

---

You must enter a remote control code **82990** first (→ 53).

### ND-S1

- Set the ND-S1 iPod/PC mode to "iPod".

### RI Dock

- Set the RI Dock's RI MODE switch to "**HDD**" or "**HDD/DOCK**".
- **ON/STANDBY** may not work with a remote control code (without **RI**). In this case, make an **RI** connection and enter a remote control code **81993** (with **RI**).

## With the RI Control

---

In this case, make an **RI** connection and enter a remote control code **81993** (with **RI**).

- Set the AV receiver's Input Display to "**DOCK**" (→ 22).

Press the appropriate **REMOTE MODE** first.

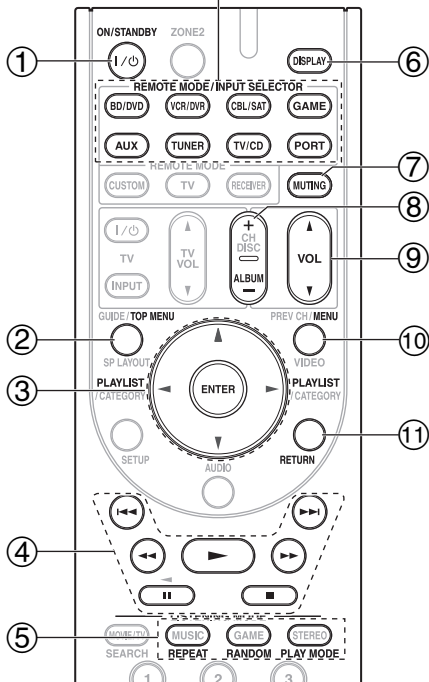

✓: Available buttons

Models sold are different depending on the region.

	Onkyo Dock	UP-A1 Dock	ND-S1	RI Dock
<b>Buttons</b>				
① ON/STANDBY I/⏻			✓	✓*1
② TOP MENU			✓*5	✓*6
③ ▲/▼/◀/▶ ENTER	✓		✓*5	✓
PLAYLIST ◀/▶		✓*3	✓	✓
④ ▶,   , ■, ◀◀, ▶▶, ◀◀, ▶▶	✓		✓	✓
⑤ REPEAT	✓		✓	✓
RANDOM	✓		✓	✓
PLAY MODE	✓*4		✓*5	✓*4
⑥ DISPLAY*7	✓*2		✓*5	✓
⑦ MUTING	✓		✓*5	✓
⑧ ALBUM +/-	✓		✓	✓
⑨ VOL ▲/▼	✓		✓*5	✓
⑩ MENU			✓*5	✓
⑪ RETURN	✓			

**Note**

- With some iPod models, generations and RI Docks, certain buttons may not work as expected.
- For detailed operation of the iPod, please refer to the instruction manual of RI Dock.

\*1 This button does not turn the Onkyo DS-A2 or DS-A2X RI Dock on or off. Your iPod may not respond the first time you press this button, in which case you should press it again.

This is because the remote controller transmits the On and Standby commands alternately, so if your iPod is already on, it will remain on when the remote controller transmits an On command.

Similarly, if your iPod is already off, it will remain off when the remote controller transmits an Off command.

\*2 Press **DISPLAY** to change the following modes:

**Standard mode**

Nothing is displayed on your TV and you navigate and select your contents by using your iPod models display.

Only this mode can playback the video.

**Extended mode**

Playlists (artists, albums, songs, and so on) are displayed on your TV, and you can navigate and select your music while looking at your TV.

\*3 In Extended mode (see \*2), **PLAYLIST** is used as the page jump button.

With the page modes, you can quickly locate your favorite songs even when your song lists, artist lists, and so on are very long.

\*4 **Resume mode**

With the Resume function, you can resume playback of the song that was playing when you removed your iPod from the RI Dock or changed the OSD mode to Off.

\*5 Operation can be performed if you connect ND-S1 via **RI** inputting the RI cable.

\*6 **TOP MENU** works as a Mode button when used with a DS-A2 RI Dock.

\*7 **DISPLAY** turns on backlight for 30 seconds.

**Note**

- In Extended mode (see \*2), the playback will be continued even if the AV receiver is turned off.
- In Extended mode (see \*2), you cannot operate your iPod directly.
- In Extended mode (see \*2), it may take some time to acquire the contents.
- In Extended mode (see \*2), video contents can not display on your TV.

# Controlling Other Components

You can use the AV receiver's remote controller (RC-764M) to control your other AV components. This section explains how to enter the remote control code (with the default underlined) for a component that you want to control: DVD, TV, CD, etc.

## Preprogrammed Remote Control Codes

The following **REMOTE MODE** are preprogrammed with remote control codes for controlling the components listed. You do not need to enter a remote control code to control these components.

For details on controlling these components, see the pages indicated.

**BD/DVD** Onkyo Blu-ray Disc player (→ 54)

**TV/CD** Onkyo CD player (→ 54)

**PORT** Onkyo Universal Port Option (→ 51)

## Entering Remote Control Codes

You'll need to enter a code for each component that you want to control.

### 1 Look up the appropriate remote control code in the separate Remote Control Codes list.

The codes are organized by category (e.g., DVD player, TV, etc.).

### 2 While holding down **REMOTE MODE** to which you want to enter a code, press and hold down **DISPLAY** until the remote indicator lights (about 3 seconds).

#### Note

- Remote control codes cannot be entered for **RECEIVER** and **ZONE 2**.
- Only TV remote control codes can be entered for **TV**.
- Apart from **RECEIVER**, **TV**, and **ZONE 2**, remote control codes from any category can be entered for **REMOTE MODE**. However, these buttons also work as input selector buttons (→ 21), so choose a **REMOTE MODE** that corresponds with the input to which you connect your component. For example, if you connect your CD player to the CD input, choose **TV/CD** when entering its remote control code.

### 3 Within 30 seconds, use the number buttons to enter the 5-digit remote control code.

The remote indicator flashes twice.

If the remote control code is not entered successfully, the remote indicator will flash once slowly.

#### Note

- The remote control codes provided are correct at the time of printing, but are subject to change.

## Remote Control Codes for Onkyo Components Connected via RI

Onkyo components that are connected via **RI** are controlled by pointing the remote controller at the AV receiver, not the component. This allows you to control components that are out of view, in a rack, for example.

### 1 Make sure the Onkyo component is connected with an **RI** cable and an analog audio cable (RCA).

See "Connecting Onkyo **RI** Components" for details (→ 17).

### 2 Enter the appropriate remote control code for **REMOTE MODE**.

#### • **BD/DVD**

##### ▶ **31612**:

Onkyo DVD player with **RI**

#### • **TV/CD**

##### ▶ **71327**:

Onkyo CD player with **RI**

##### ▶ **42157**:

Onkyo cassette recorder with **RI**

#### • **PORT**

##### ▶ **81993**:

Onkyo Dock

See the previous section for how to enter remote control codes.

#### Note

- When using a cassette tape deck connected via **RI**, press and hold **TV/CD** to switch to **TAPE**.

### 3 Press **REMOTE MODE**, point the remote controller at the AV receiver, and operate the component.

If you want to control an Onkyo component by pointing the remote controller directly at it, or you want to control an Onkyo component that's not connected via **RI**, use the following remote control codes:

#### • **BD/DVD**

##### ▶ **30627**:

Onkyo DVD player without **RI**

#### • **TV/CD**

##### ▶ **71817**:

Onkyo CD player without **RI**

##### ▶ **11807**:

Onkyo TV

If you want to control an Onkyo component by pointing the remote controller directly at it, use the following remote control codes:

- ▶ **32900:**  
Onkyo Blu-ray Disc player
- ▶ **32901:**  
Onkyo HD-DVD player
- ▶ **70868:**  
Onkyo MD recorder
- ▶ **71323:**  
Onkyo CD recorder
- ▶ **82990:**  
Onkyo Dock

#### Note

- If you connect an cassette tape deck to the **TV/CD IN** jack, or connect an RI Dock to the **TV/CD IN** or **VCR/DVR IN** or **GAME IN** jacks, for **RI** to work properly, you must set the Input Display accordingly (→ 22).

## Resetting REMOTE MODE Buttons

You can reset a **REMOTE MODE** to its default remote control code.

- 1** While holding down **REMOTE MODE** that you want to reset, press and hold down **AUDIO** until the remote indicator lights (about 3 seconds).
- 2** Within 30 seconds, press **REMOTE MODE** again.  
The remote indicator flashes twice, indicating that the button has been reset.  
Each of **REMOTE MODE** is preprogrammed with a remote control code. When a button is reset, its pre-programmed code is restored.

## Resetting the Remote Controller

You can reset the remote controller to its default settings.

- 1** While holding down **RECEIVER**, press and hold down **AUDIO** until the remote indicator lights (about 3 seconds).
- 2** Within 30 seconds, press **RECEIVER** again.  
The remote indicator flashes twice, indicating that the remote controller has been reset.

## Controlling Other Components

By pressing **REMOTE MODE** that's been programmed with the remote control code for your component, you can control your component as below.

For details on entering a remote control code for a different component (→ 53).

### Controlling a TV

**TV** is preprogrammed with the remote control code for controlling a TV that supports the **RIHD**\*1. The TV must be able to receive remote control commands via **RIHD** and be connected to the AV receiver via HDMI. If controlling your TV via **RIHD** doesn't work very well, program your TV's remote control code into **TV** and use the TV remote mode to control your TV.

### Controlling a Blu-ray Disc/DVD Player, HD DVD Player or DVD Recorder

**BD/DVD** is preprogrammed with the remote control code for controlling an Onkyo Blu-ray Disc/DVD player.

**BD/DVD** is preprogrammed with the remote control code for controlling a component that supports the **RIHD**. The component must be able to receive remote control commands via **RIHD** and be connected to the AV receiver via HDMI.

Press the appropriate **REMOTE MODE** first.

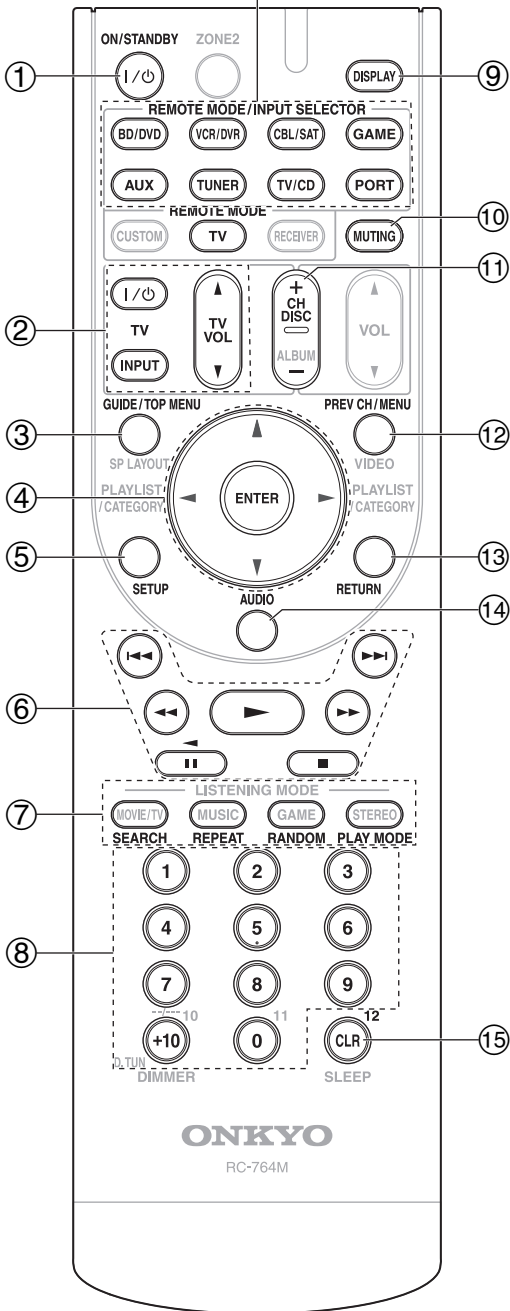

✓: Available buttons

Buttons	Components						
	TV	DVD player/DVD recorder	Blu-ray Disc player HD DVD player	VCR/PVR	Satellite receiver Cable receiver	CD player/CD recorder MD recorder	Cassette tape deck
① ON/STANDBY I/⏻	✓	✓		✓	✓	✓	✓
② I/⏻, INPUT, TV VOL ▲/▼	✓						
③ GUIDE TOP MENU	✓			✓	✓		
④ ▲/▼/◀/▶ ENTER	✓	✓		✓	✓	✓	
⑤ SETUP	✓			✓	✓	✓	
⑥ ▶, ⏸, ■, ◀◀, ▶▶, ▶▶, ◀◀, ▶▶▶	✓*1	✓		✓	✓	✓	✓*3
⑦ SEARCH	✓*1*2	✓*1	✓*2		✓*2	✓	
REPEAT	✓*1*2	✓	✓*2		✓*2	✓	
RANDOM	✓*1*2	✓*1	✓*2		✓*2	✓	
PLAY MODE	✓*1*2	✓*1	✓*2		✓*2	✓	
⑧ Number: 1 to 9, 0	✓	✓		✓	✓	✓	
Number: +10	✓*1	✓*1		✓	✓	✓	
⑨ DISPLAY	✓	✓		✓	✓	✓	
⑩ MUTING	✓	✓		✓	✓	✓	✓
⑪ CH +/- DISC +/-	✓	✓		✓	✓	✓	
⑫ PREV CH MENU	✓			✓	✓		
⑬ RETURN	✓	✓		✓	✓		
⑭ AUDIO	✓*1	✓*1			✓		
⑮ CLR	✓	✓		✓	✓	✓	

\*1 The **RIHD** function is not supported. The **RIHD** supported by the AV receiver is the CEC system control function of the HDMI standard.

\*2 These buttons function as colored buttons or A, B, C, D buttons.

\*3 **⏸** (Pause) functions as reverse playback.

#### Note

- See the “Controlling Your iPod” about the operation of iPod (→ 51).

#### Note

- With some components, certain buttons may not work as expected, and some may not work at all.

# Troubleshooting

If you have any trouble using the AV receiver, look for a solution in this section. If you can't resolve the issue yourself, contact your Onkyo dealer.

If you can't resolve the issue yourself, try resetting the AV receiver before contacting your Onkyo dealer.

**To reset the AV receiver to its factory defaults, turn it on and, while holding down VCR/DVR, press ON/STANDBY. "Clear" will appear on the display and the AV receiver will enter Standby mode.**



Note that resetting the AV receiver will delete your radio presets and custom settings.

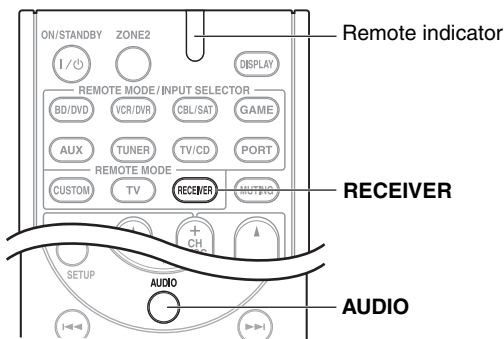

To reset the remote controller to its factory defaults, while holding down **RECEIVER**, press and hold down **AUDIO** until the remote indicator lights (about 3 seconds). Within 30 seconds, press **RECEIVER** again.

The on-screen setup menus appear only on a TV that is connected to the **HDMI OUT**. If your TV is connected to the **MONITOR OUT V** or the **COMPONENT VIDEO OUT**, use the AV receiver's display when changing settings.

## Power

### ■ Can't turn on the AV receiver

Make sure that the power cord is properly plugged into the wall outlet. —

Unplug the power cord from the wall outlet, wait five seconds or more, then plug it in again. —

### ■ The STANDBY indicator flashes red

The protection circuit has been activated. Remove the power cord from the wall outlet immediately. Disconnect all speaker cables and input sources, and leave the AV receiver with its power cord disconnected for 1 hour. After that, reconnect the power cord and set the volume to maximum. If the AV receiver stays on, set the volume to minimum, disconnect the power cord, and reconnect your speakers and input sources. If the AV receiver turns off when you set the volume to maximum, disconnect the power cord, and contact your Onkyo dealer. —

## Audio

### ■ There's no sound, or it's very quiet

Make sure that the digital input source is selected properly. **35**

Make sure that all audio connecting plugs are pushed in all the way. **14**

Make sure that the inputs and outputs of all components are connected properly. **15-17**

Make sure that the polarity of the speaker cables is correct, and that the bare wires are in contact with the metal part of each speaker terminal. **11**

Make sure that the input source is properly selected. **21**

Make sure that the speaker cables are not shorting. **11**

Check the volume. The AV receiver is designed for home theater enjoyment. It has a wide volume range, allowing precise adjustment. —

While a pair of headphones is connected to the **PHONES** jack, no sound is output by the speakers. **22**

If there's no sound from a DVD player connected to an **HDMI IN**, check the DVD player's output settings, and be sure to select a supported audio format. —

Check the digital audio output setting on the connected device. On some game consoles, such as those that support DVD, the default setting is off. —

With some DVD-Video discs, you need to select an audio output format from a menu. —

If your turntable uses an MC cartridge, you must connect an MC head amp, or an MC transformer. —

Make sure that none of the connecting cables are bent, twisted, or damaged. —

Not all listening modes use all speakers. **30**

Specify the speaker distances and adjust the individual speaker levels. **37**

Make sure that the speaker setup microphone is not still connected. —

The input signal format is set to PCM or DTS. Set it to Auto. **45**

### ■ Only the front speakers produce sound

When the Stereo or Mono listening mode is selected, only the front speakers and subwoofer produce sound. —

Check the Speaker Configuration. **36**



## ■ Only the center speaker produces sound

If you use the Dolby Pro Logic IIx Movie, Dolby Pro Logic IIx Music, or Dolby Pro Logic IIx Game listening mode with a mono source, such as an AM radio station or mono TV program, the sound is concentrated in the center speaker.

Make sure the speakers are configured correctly. **36**

## ■ The surround speakers produce no sound

When the T-D (Theater-Dimensional), Stereo or Mono listening mode is selected, the surround speakers produce no sound.

Depending on the source and current listening mode, not much sound may be produced by the surround speakers. Try selecting another listening mode.

Make sure the speakers are configured correctly. **36**

## ■ The center speaker produces no sound

When the Stereo or Mono listening mode is selected, the center speaker produces no sound.

Make sure the speakers are configured correctly. **36**

## ■ The front high or surround back speakers produce no sound

Depending on the current listening mode, no sound may be produced by the front high or surround back speakers. Select another listening mode. **30**

Not much sound may be produced by the front high or surround back speakers with some sources.

Make sure the speakers are configured correctly. **36**

While Powered Zone 2 is being used, playback in the main room is reduced to 5.1-channels and the front high or surround back speakers produce no sound. **46**

## ■ The subwoofer produces no sound

When you play source material that contains no information in the LFE channel, the subwoofer produces no sound.

Make sure the speakers are configured correctly. **36**

## ■ There's no sound with a certain signal format

Check the digital audio output setting on the connected device. On some game consoles, such as those that support DVD, the default setting is off.

With some DVD-Video discs, you need to select an audio output format from a menu.

Depending on the input signal, some listening modes cannot be selected. **30-33**

## ■ Can't select the Pure Audio listening mode

(European and Asian models) The Pure Audio listening mode cannot be selected while Zone 2 is on.

## ■ Can't get 6.1/7.1 playback

If no surround back speakers or front high speakers are connected, or the Zone 2 speakers are being used, 6.1/7.1 playback is not possible.

You can not always select all of the listening modes, depending on the number of the speakers connected. **30-33**

## ■ The volume cannot be set to 79

Check to see if a maximum volume has been set. **21**

If the volume level of each individual speaker has been adjusted to high positive values, then the maximum master volume possible may be reduced. Note that the individual speaker volume levels are set automatically after the Audyssey 2EQ® Room Correction and Speaker Setup function has been completed. **23, 37**

## ■ Noise can be heard

Using cable ties to bundle audio cables with power cords, speaker cables, and so on may degrade the audio performance, so don't do it.

An audio cable may be picking up interference. Try repositioning your cables.

## ■ The Late Night function doesn't work

Make sure the source material is Dolby Digital, Dolby Digital Plus, and Dolby TrueHD. **43**

## ■ About DTS signals

When DTS program material ends and the DTS bitstream stops, the AV receiver remains in DTS listening mode and the DTS indicator remains on. This is to prevent noise when you use the pause, fast forward, or fast reverse function on your player. If you switch your player from DTS to PCM, because the AV receiver does not switch formats immediately, you may not hear any sound, in which case you should stop your player for about three seconds, and then resume playback.

With some CD and LD players, you won't be able to playback DTS material properly even though your player is connected to a digital input on the AV receiver. This is usually because the DTS bitstream has been processed (e.g., output level, sampling rate, or frequency response changed) and the AV receiver doesn't recognize it as a genuine DTS signal. In such cases, you may hear noise.

When playing DTS program material, using the pause, fast forward, or fast reverse function on your player may produce a short audible noise. This is not a malfunction.

## ■ The beginning of audio received by an HDMI IN can't be heard

Since it takes longer to identify the format of an HDMI signal than it does for other digital audio signals, audio output may not start immediately.

## Video

### ■ There's no picture

Make sure that all video connecting plugs are pushed in all the way. **14**

Make sure that each video component is properly connected. **15, 16, 49**

If the video source is connected to a component video input, you must assign that input to an input selector, and your TV must be connected to **COMPONENT VIDEO MONITOR OUT**. **16, 35**

If the video source is connected to a composite video input, your TV must be connected to the corresponding composite video output.	<b>16</b>
If the video source is connected to an HDMI input, you must assign that input to an input selector, and your TV must be connected to the HDMI OUT.	<b>15, 35</b>
While the Pure Audio listening mode is selected, the video circuitry is turned off and only video signals input through HDMI IN can be output.	—
On your TV, make sure that the video input to which the AV receiver is connected is selected.	—

### ■ There's no picture from a source connected to an HDMI IN

Reliable operation with an HDMI-to-DVI adapter is not guaranteed. In addition, video signals from a PC are not guaranteed.	<b>62</b>
--	-----------

### ■ The on-screen menus don't appear

On your TV, make sure that the video input to which the AV receiver is connected is selected.	—
When the AV receiver doesn't connect TV with HDMI, onscreen menus are not displayed.	—

## Tuner

### ■ Reception is noisy, FM stereo reception is noisy, or the FM STEREO indicator doesn't light

Relocate your antenna.	—
Move the AV receiver away from your TV or computer.	—
Listen to the station in mono.	<b>25</b>
When listening to an AM station, operating the remote controller may cause noise.	—
Passing cars and airplanes can cause interference.	—
Concrete walls weaken radio signals.	—
If nothing improves the reception, install an outdoor antenna.	—

## Remote Controller

### ■ The remote controller doesn't work

Before operating this unit, be sure to press <b>RECEIVER</b> .	—
Make sure that the batteries are installed with the correct polarity.	<b>4</b>
Install new batteries. Don't mix different types of batteries, or old and new batteries.	<b>4</b>
Make sure that the remote controller is not too far away from the AV receiver, and that there's no obstruction between the remote controller and the AV receiver's remote control sensor.	<b>4</b>
Make sure that the AV receiver is not subjected to direct sunshine or inverter-type fluorescent lights. Relocate if necessary.	—
If the AV receiver is installed in a rack or cabinet with colored-glass doors, the remote controller may not work reliably when the doors are closed.	—
Make sure you've selected the correct remote controller mode.	<b>9, 54</b>
When using the remote controller to control other manufacturers' AV components, some buttons may not work as expected.	—

Make sure you've entered the correct remote control code.	<b>53</b>
---	-----------

Make sure to set the same ID on both the AV receiver and remote controller.	<b>41</b>
---	-----------

### ■ Can't control other components

If it's an Onkyo component, make sure that the <b>RI</b> cable and analog audio cable are connected properly. Connecting only an <b>RI</b> cable won't work.	<b>17</b>
--	-----------

Make sure you've selected the correct remote controller mode.	<b>9, 54</b>
---	--------------

If you've connected a cassette tape deck, to the <b>TV/ CD IN</b> jack, or an RI Dock to the <b>TV/CD IN</b> or <b>GAME IN</b> or <b>VCR/DVR IN</b> jacks, for the remote controller to work properly, you must set the display.	<b>22</b>
--	-----------

If you cannot operate it, you will need to enter the appropriate remote control code.	<b>53</b>
---	-----------

To control another manufacturer's component, point the remote controller at that component.	<b>53</b>
---	-----------

To control an Onkyo component that's connected via <b>RI</b> , point the remote controller at the AV receiver. Be sure to enter the appropriate remote control code first.	<b>53</b>
--	-----------

To control an Onkyo component that's not connected via <b>RI</b> , point the remote controller at the component. Be sure to enter the appropriate remote control code first.	<b>53</b>
--	-----------

The entered remote control code may not be correct. If more than one code is listed, try each one.	—
--	---

## UP-A1 Dock for iPod

### ■ There's no sound

Make sure your iPod is actually playing.	—
Make sure your iPod is inserted properly in the Dock.	—
Make sure the UP-A1 Dock is connected to the <b>UNI-VERSAL PORT</b> jack on the AV receiver.	—
Make sure the AV receiver is turned on, the correct input source is selected, and the volume is turned up.	—
Make sure the plugs are pushed in all the way.	—
Try resetting your iPod.	—

### ■ There's no video

Make sure that your iPod's TV OUT setting is set to On.	—
Make sure the correct input is selected on your TV or the AV receiver.	—
Some versions of the iPod do not output video.	—

### ■ The AV receiver's remote controller doesn't control your iPod

Make sure your iPod is properly inserted in the Dock. If your iPod is in a case, it may not connect properly to the Dock. Always remove your iPod from the case before inserting it into the Dock.	—
The iPod cannot be operated while it's displaying the Apple logo.	—
Make sure you've selected the right remote mode.	—
When you use the AV receiver's remote controller, point it toward your AV receiver.	—

When connecting UP-A1 Dock to the radio tuner UP-HT1 (North American models)/UP-DT1 (European and Asian models) with AUTO selected by the tuner's Mode Selector switch, you can switch the input source between UP-A1 Dock and the tuner, by pressing **PORT** repeatedly on the front panel.

If you still can't control your iPod, start playback by pressing your iPod's Play button. Remote operation should then be possible.

Try resetting your iPod.

Depending on your iPod, some buttons may not work as expected.

## ■ The AV receiver unexpectedly selects your iPod as the input source

Always pause iPod playback before selecting a different input source. If playback is not paused, the Direct Change function may select your iPod as the input source by mistake during the transition between tracks.

## Recording

### ■ Can't record

On your recorder, make sure the correct input is selected.

When the Pure Audio listening mode is selected, recording is not possible because no video signals are output. Select another listening mode.

## Zone 2

### ■ There's no sound

Only components connected to analog inputs can be played in Zone 2.

## Others

### ■ The sound changes when I connect my headphones

When a pair of headphones is connected, the listening mode is set to Stereo, unless it's already set to Stereo, Mono, Direct, or Pure Audio. (Pure Audio listening mode is not available for North American models.)

### ■ The display doesn't work

The display is turned off when the Pure Audio listening mode is selected.

### ■ How do I change the language of a multiplex source

Use the "Multiplex" setting on the "Audio Adjust" 37 menu to select "Main" or "Sub".

### ■ The RI functions don't work

To use **RI**, you must make an **RI** connection and an analog audio connection (RCA) between the component and AV receiver, even if they are connected digitally. 17

### ■ The functions and Direct Change don't work for components connected via RI

These functions don't work when Zone 2 is turned on. 17

### ■ When performing "Audyssey 2EQ® Room Correction and Speaker Setup", the measurement fails showing the message "Ambient noise is too high."

This can be caused by any malfunction in your speaker unit. Check if the unit produces normal sounds.

### ■ The following settings can be made for the composite video inputs

You must use the buttons on the unit to make these settings.

1. While holding down the input selector button for the input source that you want to set, press **SETUP**.
2. Use **◀/▶** to change the setting.
3. Press the input selector button for the input source that you want to set when you've finished.

#### • Video Attenuation

This setting can be made for the **BD/DVD**, **VCR/DVR**, **CBL/SAT**, **GAME**, or **AUX** input.

If you have a games console connected to the composite video input, and the picture isn't very clear, you can attenuate the gain.

**Video ATT:OFF:** (default).

**Video ATT:ON:** Gain is reduced by 2 dB.

The AV receiver contains a microcomputer for signal processing and control functions. In very rare situations, severe interference, noise from an external source, or static electricity may cause it to lockup. In the unlikely event that this happens, unplug the power cord from the wall outlet, wait at least five seconds, and then plug it back in again.

Onkyo is not responsible for damages (such as CD rental fees) due to unsuccessful recordings caused by the unit's malfunction. Before you record important data, make sure that the material will be recorded correctly.

Before disconnecting the power cord from the wall outlet, set the AV receiver to Standby.

# Specifications

## Amplifier Section

**Rated Output Power**  
All channels: (North American)  
80 watts minimum continuous power per channel, 8 ohm loads, 2 channels driven from 20 Hz to 20 kHz, with a maximum total harmonic distortion of 0.08% (FTC)  
90 watts minimum continuous power per channel, 8 ohm loads, 2 channels driven at 1 kHz, with a maximum total harmonic distortion of 0.7% (FTC)  
100 watts minimum continuous power per channel, 6 ohm loads, 2 channels driven at 1 kHz, with a maximum total harmonic distortion of 0.1% (FTC)  
(Others)  
7 ch × 130 W at 6 ohms, 1 kHz, 1 ch driven (IEC)

**Maximum Effective Output Power**  
(Asian)  
7 ch × 160 W at 6 ohms, 1 kHz, 1 ch driven (JEITA)

**Dynamic Power**  
180 W (3 Ω, Front)  
160 W (4 Ω, Front)  
100 W (8 Ω, Front)

**THD (Total Harmonic Distortion)**  
(North American)  
0.08% (Power Rated)  
(Others)  
0.08% (1 kHz, 1 W)

**Damping Factor** 60 (Front, 1 kHz, 8 Ω)

**Input Sensitivity and Impedance**  
200 mV/47 kΩ (LINE)

**Output Level and Impedance**  
200 mV/2.2 kΩ (REC OUT)

**Frequency Response** 5 Hz - 100 kHz/+1 dB, -3 dB (DSP bypass)

**Tone Control Characteristics**  
±10 dB, 50 Hz (BASS)  
±10 dB, 20 kHz (TREBLE)

**Signal to Noise Ratio** 106 dB (LINE, IHF-A)

**Speaker Impedance** (North American) 6 Ω - 16 Ω  
(Others) 4 Ω - 16 Ω

## Video Section

**Input Sensitivity/Output Level and Impedance**  
1 V<sub>p-p</sub>/75 Ω (Component Y)  
0.7 V<sub>p-p</sub>/75 Ω (Component P<sub>B</sub>/C<sub>B</sub>, P<sub>R</sub>/C<sub>R</sub>)  
1 V<sub>p-p</sub>/75 Ω (Composite)

**Component Video Frequency Response**  
5 Hz - 100 MHz/+0 dB, -3 dB

## Tuner Section

**FM Tuning Frequency Range**  
(North American) 87.5 MHz - 107.9 MHz  
(European) 87.50 MHz - 108.00 MHz, RDS  
(Others) 87.5 MHz - 108.0 MHz, RDS

**AM Tuning Frequency Range**  
(North American) 530 kHz - 1710 kHz  
(Others) 522/530 kHz - 1611/1710 kHz

**Preset Channel** 40

**Digital Tuner (North American models)**  
SIRIUS

## General

**Power Supply** (North American) AC 120 V, 60 Hz  
(European) AC 230 V, 50 Hz  
(Others) AC 220 - 240 V, 50/60 Hz

**Power Consumption** (North American) 4.9 A  
(European) 450 W  
(Others) 500 W

**Stand-by Power Consumption**  
(North American) 0.2 W  
(Others) 0.3 W

**Dimensions**  
(W × H × D) 435 mm × 151.5 mm × 328.5 mm  
17-1/8" × 5-15/16" × 12-15/16"

**Weight** (North American)  
8.6 kg (19.0 lbs.)  
(Others)  
9.4 kg (20.7 lbs.)

### ■ HDMI

**Input** IN 1, IN 2, IN 3, IN 4  
**Output** OUT  
**Video Resolution** 1080p  
**Audio Format** Dolby True HD, DTS Master Audio, DVD-Audio, DSD  
**Supported** 3D, Audio Return Channel, Deep Color, x.v.Color, LipSync, CEC

### ■ Video Inputs

**Component** IN 1, IN 2  
**Composite** BD/DVD, VCR/DVR, CBL/SAT, GAME, AUX

### ■ Video Outputs

**Component** OUT  
**Composite** MONITOR OUT, VCR/DVR OUT

### ■ Audio Inputs

**Digital** Optical: 2  
Coaxial: 2  
**Analog** BD/DVD, VCR/DVR, CBL/SAT, GAME, TV/CD, AUX

### ■ Audio Outputs

**Analog** VCR/DVR, ZONE2 Line Out  
**Subwoofer Pre Output** 1  
**Speaker Outputs** Main (L, R, C, SL, SR, SBL, SBR) + ZONE2 / Front High (L, R)  
**Phones** 1 (6.3 ø)

### ■ Others

**Mic** 1  
**Universal Port** 1  
**RI** 1

Specifications and features are subject to change without notice.

# About HDMI

---

Designed to meet the increased demands of digital TV, HDMI (High Definition Multimedia Interface) is a new digital interface standard for connecting TVs, projectors, Blu-ray Disc players/DVD players, set-top boxes, and other video components. Until now, several separate video and audio cables have been required to connect AV components. With HDMI, a single cable can carry control signals, digital video, and up to eight channels of digital audio (2-channel PCM, multichannel digital audio, and multichannel PCM).

The HDMI video stream (i.e., video signal) is compatible with DVI (Digital Visual Interface)\*1, so TVs and displays with a DVI input can be connected by using an HDMI-to-DVI adapter cable. (This may not work with some TVs and displays, resulting in no picture.)

The AV receiver uses HDCP (High-bandwidth Digital Content Protection)\*2, so only HDCP-compatible components can display the picture.

The AV receiver's HDMI interface is based on the following:  
Audio Return Channel, 3D, x.v.Color, Deep Color, Lip Sync, DTS-HD Master Audio, DTS-HD High Resolution Audio, Dolby TrueHD, Dolby Digital Plus, DSD and Multichannel PCM

---

## Supported Audio Formats

---

- 2-channel linear PCM (32–192 kHz, 16/20/24 bit)
- Multichannel linear PCM (up to 7.1 ch, 32–192 kHz, 16/20/24 bit)
- Bitstream (DSD, Dolby Digital, Dolby Digital Plus, Dolby TrueHD, DTS, DTS-HD High Resolution Audio, DTS-HD Master Audio)

Your Blu-ray Disc player/DVD player must also support HDMI output of the above audio formats.

---

## About Copyright Protection

---

The AV receiver supports HDCP (High-bandwidth Digital Content Protection)\*2, a copy-protection system for digital video signals. Other devices connected to the AV receiver via HDMI must also support HDCP.

\*1 DVI (Digital Visual Interface): The digital display interface standard set by the DDWG\*3 in 1999.

\*2 HDCP (High-bandwidth Digital Content Protection): The video encryption technology developed by Intel for HDMI/DVI. It's designed to protect video content and requires a HDCP-compatible device to display the encrypted video.

\*3 DDWG (Digital Display Working Group): Lead by Intel, Compaq, Fujitsu, Hewlett Packard, IBM, NEC, and Silicon Image, this open industry group's objective is to address the industry's requirements for a digital connectivity specification for high-performance PCs and digital displays.

### Note

- The HDMI video stream is compatible with DVI (Digital Visual Interface), so TVs and displays with a DVI input can be connected by using an HDMI-to-DVI adapter cable. (Note that DVI connections only carry video, so you'll need to make a separate connection for audio.) However, reliable operation with such an adapter is not guaranteed. In addition, video signals from a PC are not supported.
- The HDMI audio signal (sampling rate, bit length, etc.) may be restricted by the connected source component. If the picture is poor or there's no sound from a component connected via HDMI, check its setup. Refer to the connected component's instruction manual for details.

# Using an RIHD-compatible TV, Player, or Recorder

**RIHD**, which stands for Remote Interactive over HDMI, is the name of the system control function found on Onkyo components. The AV receiver can be used with CEC (Consumer Electronics Control), which allows system control over HDMI and is part of the HDMI standard. CEC provides interoperability between various components, however, operation with components other than **RIHD**-compatible components cannot be guaranteed.

## ■ About **RIHD**-compatible components

The following components are **RIHD**-compatible. (As of February 2010) See the Onkyo web site for latest information.

### TV

- Panasonic VIERA Link compatible TV
- Toshiba REGZA-LINK compatible TV
- Sharp TV (See Onkyo web site for latest information on compatible models.)

### Players/Recorders

- Onkyo and Integra **RIHD**-compatible players
- Panasonic VIERA Link compatible players and recorders (only when used together with Panasonic VIERA Link compatible TV)
- Toshiba REGZA-LINK compatible players and recorders (only when used together with Toshiba REGZA-LINK compatible TV)
- Sharp players and recorders (only when used together with Sharp TV)

\* Models other than those mentioned above may have some interoperability if compatible with CEC which is part of the HDMI Standard, but operation cannot be guaranteed.

### Note

- Do not connect the **RIHD**-compatible component more than the following number to the HDMI input terminal so that the linked operations work properly.
  - Blu-ray Disc/DVD player is up to three.
  - Blu-ray Disc recorder/DVD recorder/Digital Video Recorder is up to three.
  - Cable/Satellite Set-top box is up to four.
- Do not connect the AV receiver to the other AV receiver/AV amplifier via HDMI.
- When the **RIHD**-compatible component more than the above-mentioned is connected, the linked operations are not guaranteed.

## ■ Operations that can be performed with **RIHD** connection

### For **RIHD**-compatible TV

The following linked operation is possible by connecting the AV receiver to an **RIHD**-compatible TV.

- The AV receiver will enter Standby mode when the power of the TV is turned to Standby.
- You can set on the menu screen of the TV to either output the audio from the speakers connected to the AV receiver, or from the speakers of the TV.
- It is possible to output the video/audio from the antenna or from the input jack of the TV from the speakers connected to the AV receiver. (A connection such as optical digital cable or similar is required above the HDMI cable.)
- Input to the AV receiver can be selected with the remote controller of the TV.
- Operations such as volume adjustment or similar for the AV receiver can be performed from the remote controller of the TV.

### For **RIHD**-compatible players/recorders

The following link operation is possible by connecting the AV receiver to an **RIHD**-compatible player/recorder.

- When the playback is started on the player/recorder, input of the AV receiver will switch to the HDMI input of the player/recorder that is playing back.
- Operation of the player/recorder is possible with the remote controller supplied with the AV receiver.

\* Not all functions may operate depending on the model.

## ■ How to connect and setup

### 1 Confirm the connecting and setting.

1. Connect the **HDMI OUT** jack to the HDMI input jack of the TV.

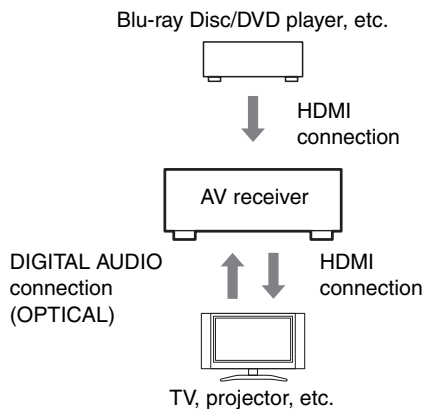

2. Connect the audio output from the TV to the **OPTICAL IN 2** jack of the AV receiver using an optical digital cable.

#### Note

- When the audio return channel (ARC) function is used with TV for HDMI 1.4, it should not be this connection (→ 42).
3. Connect the HDMI output of the Blu-ray Disc/DVD player/recorder to the **HDMI IN 1** jack of the AV receiver.

#### Note

- It is necessary to assign the HDMI input when connecting the Blu-ray Disc/DVD player/recorder to other jacks (→ 35). Do not assign the components connected to the HDMI IN to the TV/CD input at this time. Appropriate CEC (Consumer Electronics Control) operation can not be guaranteed.

### 2 Each of the “HDMI Setup” is changed to the following setting.

- HDMI Control (RIHD): On
- Audio Return Ch (ARC): Auto
- Power Control: On
- TV Control: On

See for details of each setting (→ 42).

### 3 Confirm the settings.

1. Turn on the power for all connected components.
2. Turn off the power of the TV, and confirm that the power of the connected components is turned off automatically with the link operation.
3. Turn on the power of the Blu-ray Disc/DVD player/recorder.
4. Start playback of the Blu-ray Disc/DVD player/recorder, and confirm the following.
  - The power of the AV receiver is turned on automatically, and input with the Blu-ray Disc/DVD player/recorder connected is selected.
  - The power of the TV is turned on automatically, and input with the AV receiver connected is selected.
5. Following the operating instructions of the TV, select “Use the TV speakers” from the menu screen of the TV, and confirm that the audio is output from the speakers of the TV, and not from the speakers connected to the AV receiver.
6. Select “Use the speakers connected from the AV receiver” from the menu screen of the TV, and confirm that the audio is output from the speakers connected to the AV receiver, and not from the TV speakers.

#### Note

- Perform the above operations when you initially use the AV receiver, when the settings of each component are changed, when the main power of each component is turned off, when the power cable is disconnected from the power supply, or when there has been a power outage.

### 4 Operate with the remote controller.

For buttons that can be operated (→ 54).

#### Note

- Audio from DVD-Audio or Super Audio CD may not output from the TV speakers. You will be able to output the audio from the TV speakers by setting the audio output of the DVD player to 2ch PCM. (It may not be possible depending on the player models.)
- Even if you set to output audio on the TV speakers, audio will be output from the speakers connected to the AV receiver when you adjust the volume or switch the input on the AV receiver. To output audio from the TV speakers, re-do the operations on the TV.
- Do not connect the **RI** cable when connecting to the **RI** and **RI** audio control compatible components.
- When you select anything other than the HDMI jack where the AV receiver is connected as the input on the TV, input on the AV receiver will be switched to “TV/CD”.
- The AV receiver will automatically power on in conjunction when it determines it to be necessary. Even if the AV receiver is connected to an **RIHD** compatible TV or player/recorder, it will not power on if it is not necessary. It may not power on in conjunction when the TV is set to output audio from the TV.
- Linked functions with the AV receiver may not work depending on the model. Operate the AV receiver directly in such cases.

## **ONKYO CORPORATION**

Sales & Product Planning Div. : 2-1, Nisshin-cho, Neyagawa-shi, OSAKA 572-8540, JAPAN  
Tel: 072-831-8023 Fax: 072-831-8163

### **ONKYO U.S.A. CORPORATION**

18 Park Way, Upper Saddle River, N.J. 07458, U.S.A.  
Tel: 800-229-1687, 201-785-2600 Fax: 201-785-2650 <http://www.us.onkyo.com/>

### **ONKYO EUROPE ELECTRONICS GmbH**

Liegnitzerstrasse 6, 82194 Groebenzell, GERMANY  
Tel: +49-8142-4401-0 Fax: +49-8142-4401-555 <http://www.eu.onkyo.com/>

### **ONKYO EUROPE ELECTRONICS GmbH (UK BRANCH)**

The Coach House 81A High Street, Marlow, Buckinghamshire, SL7 1AB, UK  
Tel: +44-(0)1628-473-350 Fax: +44-(0)1628-401-700

### **ONKYO CHINA LIMITED**

Unit 1 & 12, 9/F, Ever Gain Plaza Tower 1, 88, Container Port Road, Kwai Chung,  
N.T., Hong Kong. Tel: 852-2429-3118 Fax: 852-2428-9039  
<http://www.ch.onkyo.com/>

Y1002-1

SN 29400388

(C) Copyright 2010 ONKYO CORPORATION Japan. All rights reserved.



\* 2 9 4 0 0 3 8 8 \*