

ONKYO

Power Amplifier

M-5010

Instruction Manual

Thank you for purchasing an Onkyo Power Amplifier. Please read this manual thoroughly before making connections and plugging in the unit. Following the instructions in this manual will enable you to obtain optimum performance and listening enjoyment from your new Power Amplifier. Please retain this manual for future reference.

Contents

Introduction2

Connections.....7

Advanced Operations9

Others.....10

WARNING:

TO REDUCE THE RISK OF FIRE OR ELECTRIC SHOCK, DO NOT EXPOSE THIS APPARATUS TO RAIN OR MOISTURE.

CAUTION:

TO REDUCE THE RISK OF ELECTRIC SHOCK, DO NOT REMOVE COVER (OR BACK). NO USER-SERVICEABLE PARTS INSIDE. REFER SERVICING TO QUALIFIED SERVICE PERSONNEL.



WARNING
RISK OF ELECTRIC SHOCK
DO NOT OPEN

AVIS
RISQUE DE CHOC ELECTRIQUE
NE PAS OUVRIR



The lightning flash with arrowhead symbol, within an equilateral triangle, is intended to alert the user to the presence of uninsulated “dangerous voltage” within the product’s enclosure that may be of sufficient magnitude to constitute a risk of electric shock to persons.



The exclamation point within an equilateral triangle is intended to alert the user to the presence of important operating and maintenance (servicing) instructions in the literature accompanying the appliance.

Important Safety Instructions

1. Read these instructions.
2. Keep these instructions.
3. Heed all warnings.
4. Follow all instructions.
5. Do not use this apparatus near water.
6. Clean only with dry cloth.
7. Do not block any ventilation openings. Install in accordance with the manufacturer’s instructions.
8. Do not install near any heat sources such as radiators, heat registers, stoves, or other apparatus (including amplifiers) that produce heat.
9. Do not defeat the safety purpose of the polarized or grounding-type plug. A polarized plug has two blades with one wider than the other. A grounding type plug has two blades and a third grounding prong. The wide blade or the third prong are provided for your safety. If the provided plug does not fit into your outlet, consult an electrician for replacement of the obsolete outlet.
10. Protect the power cord from being walked on or pinched particularly at plugs, convenience receptacles, and the point where they exit from the apparatus.
11. Only use attachments/accessories specified by the manufacturer.
12. Use only with the cart, stand, tripod, bracket, or table specified by the manufacturer, or sold with the apparatus. When a cart is used, use caution when moving the cart/apparatus combination to avoid injury from tip-over.
13. Unplug this apparatus during lightning storms or when unused for long periods of time.
14. Refer all servicing to qualified service personnel. Servicing is required when the apparatus has been damaged in any way, such as power-supply cord or plug is damaged, liquid has been spilled or objects have fallen into the apparatus, the apparatus has been exposed to rain or moisture, does not operate normally, or has been dropped.
15. Damage Requiring Service
Unplug the apparatus from the wall outlet and refer servicing to qualified service personnel under the following conditions:
 - A. When the power-supply cord or plug is damaged,
 - B. If liquid has been spilled, or objects have fallen into the apparatus,
 - C. If the apparatus has been exposed to rain or water,
 - D. If the apparatus does not operate normally by following the operating instructions. Adjust only those controls that are covered by the operating instructions as an improper adjustment of other controls may result in damage and will often require extensive work by a qualified technician to restore the apparatus to its normal operation,
 - E. If the apparatus has been dropped or damaged in any way, and
 - F. When the apparatus exhibits a distinct change in performance this indicates a need for service.
16. Object and Liquid Entry
Never push objects of any kind into the apparatus through openings as they may touch dangerous voltage points or short-out parts that could result in a fire or electric shock.
The apparatus shall not be exposed to dripping or splashing and no objects filled with liquids, such as vases shall be placed on the apparatus.
Don’t put candles or other burning objects on top of this unit.
17. Batteries
Always consider the environmental issues and follow local regulations when disposing of batteries.
18. If you install the apparatus in a built-in installation, such as a bookcase or rack, ensure that there is adequate ventilation.
(Leave 20 cm (8”) of free space at the top and sides and 10 cm (4”) at the rear. When a shelf is located above the unit, the rear edge of the shelf shall be set 10 cm (4”) away from the backboard to improve ventilation.)

PORTABLE CART WARNING



S3125A

Precautions

1. **Recording Copyright**—Unless it's for personal use only, recording copyrighted material is illegal without the permission of the copyright holder.
2. **AC Fuse**—The AC fuse inside the unit is not user-serviceable. If you cannot turn on the unit, contact your Onkyo dealer.

3. **Care**—Occasionally you should dust the unit all over with a soft cloth. For stubborn stains, use a soft cloth dampened with a weak solution of mild detergent and water. Dry the unit immediately afterwards with a clean cloth. Don't use abrasive cloths, thinners, alcohol, or other chemical solvents, because they may damage the finish or remove the panel lettering.

4. Power

WARNING

BEFORE PLUGGING IN THE UNIT FOR THE FIRST TIME, READ THE FOLLOWING SECTION CAREFULLY.

AC outlet voltages vary from country to country. Make sure that the voltage in your area meets the voltage requirements printed on the unit's rear panel (e.g., AC 230 V, 50 Hz or AC 120 V, 60 Hz).

The power cord plug is used to disconnect this unit from the AC power source. Make sure that the plug is readily operable (easily accessible) at all times.

For models with [POWER] button, or with both [POWER] and [ON/STANDBY] buttons: Pressing the [POWER] button to select OFF mode does not fully disconnect from the mains. If you do not intend to use the unit for an extended period, remove the power cord from the AC outlet.

For models with [ON/STANDBY] button only: Pressing the [ON/STANDBY] button to select Standby mode does not fully disconnect from the mains. If you do not intend to use the unit for an extended period, remove the power cord from the AC outlet.

5. Preventing Hearing Loss

Caution

Excessive sound pressure from earphones and headphones can cause hearing loss.

6. Batteries and Heat Exposure

Warning

Batteries (battery pack or batteries installed) shall not be exposed to excessive heat as sunshine, fire or the like.

7. **Never Touch this Unit with Wet Hands**—Never handle this unit or its power cord while your hands are wet or damp. If water or any other liquid gets inside this unit, have it checked by your Onkyo dealer.

8. Handling Notes

- If you need to transport this unit, use the original packaging to pack it how it was when you originally bought it.
- Do not leave rubber or plastic items on this unit for a long time, because they may leave marks on the case.

- This unit's top and rear panels may get warm after prolonged use. This is normal.
- If you do not use this unit for a long time, it may not work properly the next time you turn it on, so be sure to use it occasionally.

For U.S. models

FCC Information for User

CAUTION:

The user changes or modifications not expressly approved by the party responsible for compliance could void the user's authority to operate the equipment.

NOTE:

This equipment has been tested and found to comply with the limits for a Class B digital device, pursuant to Part 15 of the FCC Rules. These limits are designed to provide reasonable protection against harmful interference in a residential installation.

This equipment generates, uses and can radiate radio frequency energy and, if not installed and used in accordance with the instructions, may cause harmful interference to radio communications. However, there is no guarantee that interference will not occur in a particular installation. If this equipment does cause harmful interference to radio or television reception, which can be determined by turning the equipment off and on, the user is encouraged to try to correct the interference by one or more of the following measures:

- Reorient or relocate the receiving antenna.
- Increase the separation between the equipment and receiver.
- Connect the equipment into an outlet on a circuit different from that to which the receiver is connected.
- Consult the dealer or an experienced radio/TV technician for help.

For Canadian Models

NOTE: THIS CLASS B DIGITAL APPARATUS COMPLIES WITH CANADIAN ICES-003.

For models having a power cord with a polarized plug:

CAUTION: TO PREVENT ELECTRIC SHOCK, MATCH WIDE BLADE OF PLUG TO WIDE SLOT, FULLY INSERT.

Modèle pour les Canadien

REMARQUE: CET APPAREIL NUMÉRIQUE DE LA CLASSE B EST CONFORME À LA NORME NMB-003 DU CANADA.

Sur les modèles dont la fiche est polarisée:

ATTENTION: POUR ÉVITER LES CHOCS ÉLECTRIQUES, INTRODUIRE LA LAME LA PLUS LARGE DE LA FICHE DANS LA BORNE CORRESPONDANTE DE LA PRISE ET POUSSER JUSQU'AU FOND.

Features

M-5010 Power Amplifier

- 75 W/ch (1kHz, 8 ohms, 0.08% THD, 2ch Driven FTC)
- WRAT (Wide Range Amplifier Technology)
- High Current Low Impedance Drive
- 10,000 μ F Capacitor x 2
- Three Stage Inverted Darlington Circuitry
- Copper Bus Plate for Low Impedance Drive
- 1/16" (16mm) Full-flat Chassis
- Aluminum Front Panels
- 12V Trigger in/out
- Impedance Switch (4 ~ 8 ohms and 8 ~ 16 ohms)
- Auto Power-on Function by Receiving Audio Signal
- Auto Standby Function
- OUTPUT (RCA, Through Out)

Installing the Power Amplifier

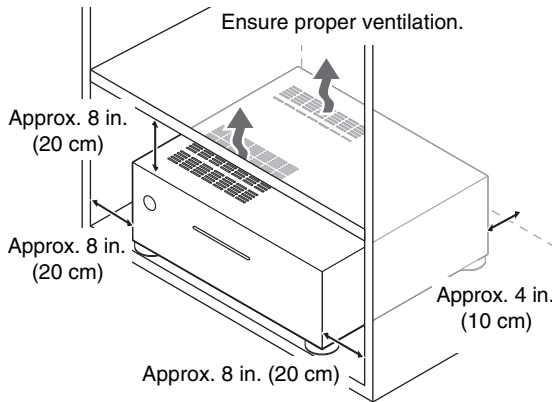

Install the power amplifier on a sturdy rack or shelf. Position it so that its weight is evenly dispersed on its four legs. Do not install the power amplifier in a place with vibration or an unstable location.

The power amplifier is designed to have high conversion efficiency, however, its temperature will become much higher than other audio equipment. Therefore, make sure not to hamper heat dissipation by ensuring proper ventilation.

Contents

Introduction

Important Safety Instructions	2
Precautions	3
Features	4
Installing the Power Amplifier	4
Getting to Know the Power Amplifier	5
Front Panel	5
Rear Panel	6

Connections

Connections	7
Cable and Jacks	7
Connecting the AV Receiver	7
Connecting Your Speakers	8
Connecting the Power Cord	8

Advanced Operations

Custom Setup	9
Setting the TRIGGER	9
Setting the Auto Standby Function	9
Setting the Speaker Impedance	9

Others

Operations	10
Troubleshooting	10
Specifications	11

Getting to Know the Power Amplifier

Front Panel

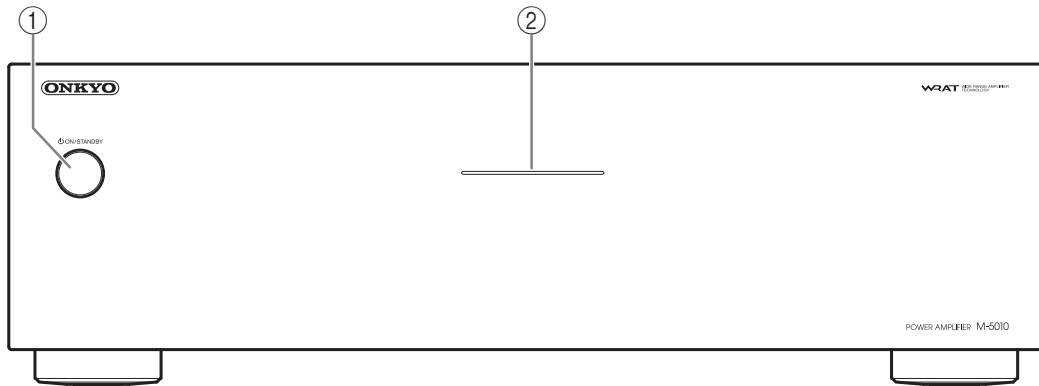

For detailed information, see the pages in parentheses.

① **ON/STANDBY button**

This button is used to turn the main power on/off.

② **Power indicator**

The power indicator will be lit blue when the main power of M-5010 is turned on.

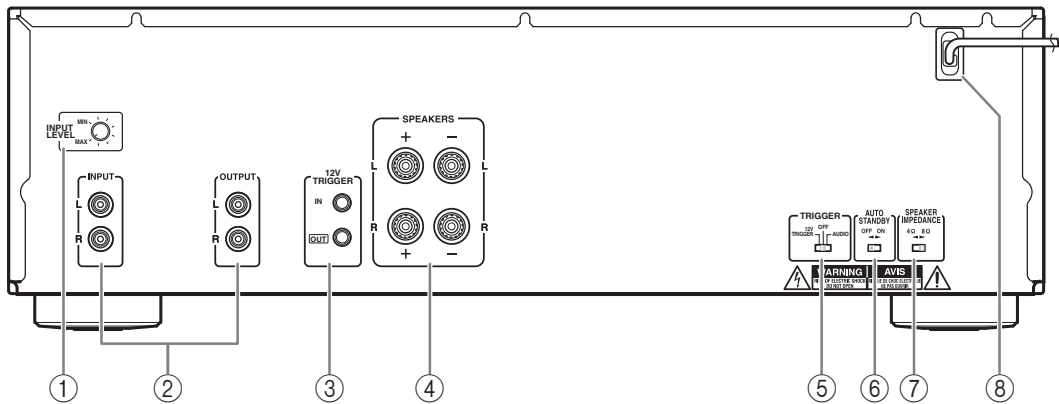

① INPUT LEVEL knob

Turn this INPUT LEVEL knob to adjust the input level of the signal from the INPUT jacks. Normally, set to MAX.

② INPUT/OUTPUT jacks

These are the analog audio inputs and outputs. Use an RCA-type audio connection cable to connect the output jacks of the device to the INPUT jacks on the M-5010. When connecting a control amplifier or preamplifier, connect the PRE OUT jacks to the INPUT jacks.

If you connect the OUTPUT jacks of the M-5010 to the INPUT jacks of another M-5010, the signal input at the INPUT jacks of the M-5010 is also output from the OUTPUT jacks (Input/Output Link Function).

③ 12V TRIGGER IN/OUT jacks

Connect the 12V TRIGGER IN jack to an AV Receiver that has a 12V TRIGGER output jack. This jack works on between 5 to 12 volts DC.

If you want another component to be activated/deactivated by turning on/off the AV receiver connected to the 12V TRIGGER IN jack of the M-5010, connect the 12V TRIGGER input jack of that component to the 12V TRIGGER OUT jack of the M-5010. In this state, the 12V TRIGGER is output when the M-5010 is turned on.

Devices can be connected in series using these jacks. Use 1/8-inch (3.5mm) monaural-type mini-jack connectors or the supplied stereo mini-plug cable. The tip polarity of the connector is positive.

④ SPEAKERS terminals

Connect Speakers.

⑤ TRIGGER selector

Set this TRIGGER switch before turning on the M-5010.

To turn on the M-5010 with the signal input from the 12V TRIGGER IN jack, set the TRIGGER switch to 12V TRIGGER.

To turn on the M-5010 with the signal input from the INPUT jack, set the TRIGGER switch to AUDIO (Auto Power On Function). If you do not use Auto Power On Function, set the TRIGGER switch to OFF.

⑥ AUTO STANDBY selector

Enables or disables the Auto standby function.

⑦ SPEAKER IMPEDANCE selector

Switches the speaker impedance to 4 Ω or 8 Ω.

⑧ POWER CORD

Connections

Cable and Jacks

Analog audio (RCA)

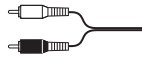

L White
R Red

Analog audio connections (RCA) carry analog audio.

Note

- Push plugs in all the way to make good connections (loose connections can cause noise or malfunctions).
- To prevent interference, keep audio cables away from power cords and speaker cables.

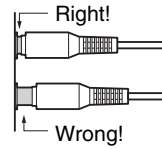

Connecting the AV Receiver

When connecting the M-5010 to AV Receiver, connect the INPUT jacks of the M-5010 to the PRE OUT jacks of the AV Receiver, and connect the front speakers to the SPEAKERS terminals of the M-5010.

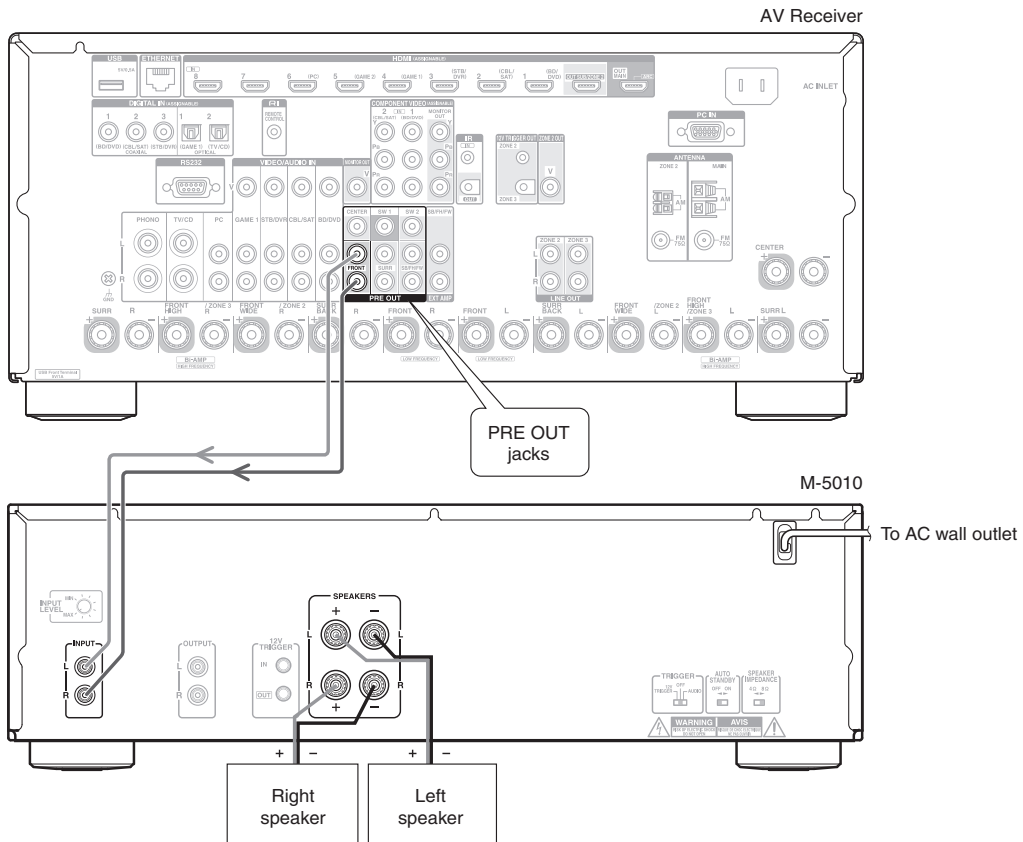

Connecting Your Speakers

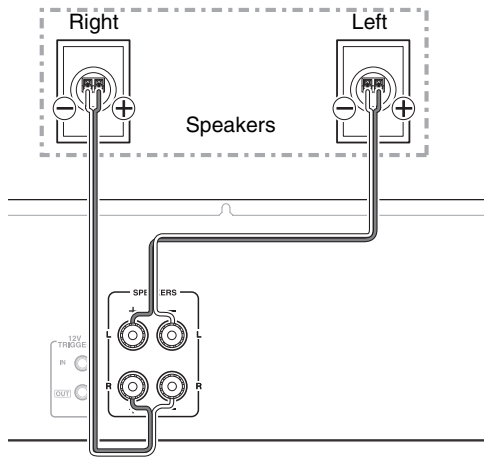

■ Screw-type speaker terminals

Strip 1/2" to 5/8" (12 to 15 mm) of insulation from the ends of the speaker cables, and twist the bare wires tightly, as shown.

1/2" to 5/8" (12 to 15 mm)

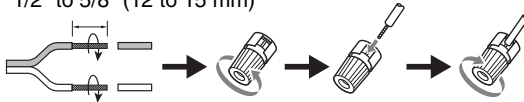

■ Banana Plugs

- If you are using banana plugs, tighten the speaker terminal before inserting the banana plug.
- Do not insert the speaker code directly into the center hole of the speaker terminal.

Note

- Pay close attention to speaker wiring polarity. In other words, connect positive (+) terminals only to positive (+) terminals, and negative (–) terminals only to negative (–) terminals. If you get them the wrong way around, the sound will be out of phase and will feel unnatural.
- Be careful not to short the positive and negative wires. Doing so may damage the power amplifier.
- Make sure the metal core of the wire does not have contact with the power amplifier's rear panel. Doing so may damage the power amplifier.

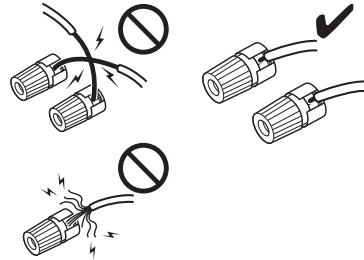

- Don't connect more than one speaker wire to a single speaker terminal. Doing so could damage the power amplifier or cause it to malfunction.

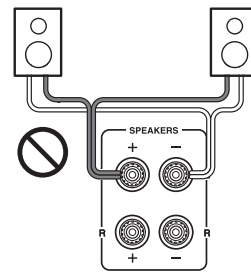

Connecting the Power Cord

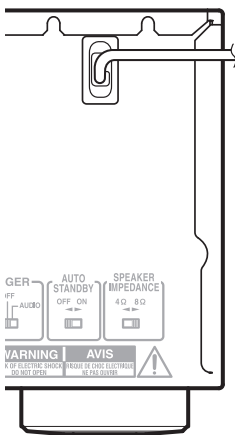

Tip

- To reduce noise, do not tie signal cables together with the power cable. Wire them so that they are away from each other.
- Depending on the country, the power amplifier may be polarity-sensitive. In this case, plug the power cord in a way that provides the best sound quality.

Note

- Turning on the power amplifier may cause a momentary power surge that might interfere with other electrical equipment on the same circuit. If this is a problem, plug the power amplifier into a different branch circuit.

- 1 Connect all of your speakers and components.
- 2 Plug the power cord into an AC wall outlet.

Custom Setup

Setting the TRIGGER

Make TRIGGER selector settings if you want to turn the power on and off along with other equipment.

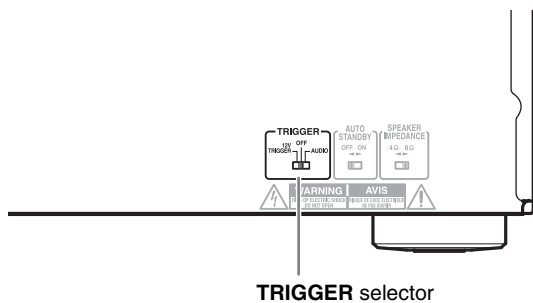

1 Switch the TRIGGER selector on the unit's rear panel.

- ▶ [12V TRIGGER]
The M-5010 will be turned on when the 12V TRIGGER jacks are provided with power.
- ▶ [AUDIO]
The M-5010 will be turned on when the INPUT jacks are provided with an audio signal.

Note:

The power will not be turned off automatically if the TRIGGER selector is set to AUDIO.

Use the Auto Standby function if you want to turn off the power automatically.

- ▶ [OFF] (default)
Set the TRIGGER selector to OFF if you want to turn the M-5010 on or off independently from other equipment.

Setting the Auto Standby Function

When the Auto Standby (ASb) function is activated, the power amplifier will automatically enter Standby mode if there is no operation for 3 hours with no audio signal input.

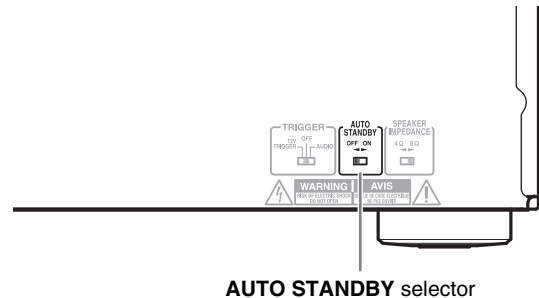

1 Switch the AUTO STANDBY selector on the unit's rear panel.

- ▶ [ON]
Enables auto standby.
- ▶ [OFF] (default)
Disables auto standby.

Setting the Speaker Impedance

You can set the impedance of the speakers that you connect to the unit.

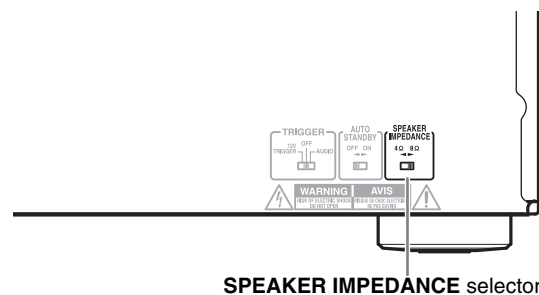

1 Switch the SPEAKER IMPEDANCE selector on the unit's rear panel.

- ▶ [4 Ω or more and less than 8 Ω]
Sets the impedance to 4 Ω.
- ▶ [8 Ω or more and 16 Ω or less]
Sets the impedance to 8 Ω. (default)

Caution

- Settings will not be enabled even when the selector is changed in the Standby mode.
To change a setting, be sure to turn on the unit prior to making any changes.

Operations

To listen to music or view your favorite movies, follow the operations below.

The procedures given below assume that the other system components are already connected. (For example, that the source components are already connected to the control amplifier or the preamplifier.)

1 Lower the volume at the control amplifier or preamplifier.

Lower the volume of the control amplifier or preamplifier to the minimum so that when the M-5010 is turned on, you do not hear loud unwanted sounds.

2 Turn on the M-5010 and select the input on the control amplifier or preamplifier.

Select the proper input on the control amplifier or preamplifier.

3 Slowly increase the volume of the control amplifier or preamplifier.

Now all that remains is to control the control amplifier or preamplifier and the other connected system components to enjoy your music or movies.

Troubleshooting

The Standby/On indicator does not light when the ON/STANDBY button is pressed.

- Bad connections or wiring.
 - ➔ Check if the power cord is properly connected. If the indicator still does not light, turn off the M-5010, disconnect the power cord, and contact the dealer from whom you purchased this unit.

The Power indicator lights blue, but no sound comes from the speaker or the volume is very low.

- Bad connections or wiring.
 - ➔ Check connections, speaker cables, etc.
- The INPUT LEVEL control is set to MIN.
 - ➔ Turn the INPUT LEVEL control to adjust the input level.
- The settings on the control amplifier or preamplifier are wrong.
 - ➔ Check the settings on the control amplifier or preamplifier.

The left and right sounds are unbalanced or reversed.

- Bad connections or wiring.
 - ➔ Check connections, RCA-type audio connection cable, etc.
- The polarity of the speaker cable is wrong.
 - ➔ Check the polarity of the speaker cable.

The TRIGGER switch does not react.

- ➔ Check that the TRIGGER switch is effective.
- ➔ Turn on the power supply once.

Specifications

Rated Output Power (FTC) 75 watts minimum continuous power per channel, 8 ohm loads, 2 channels driven at 1 kHz, with a maximum total harmonic distortion of 0.08 %
(FTC) 65 watts minimum continuous power per channel, 4 ohm loads, 2 channels driven at 1 kHz, with a maximum total harmonic distortion of 0.08 %

THD+N (Total Harmonic Distortion+N)
0.08 % (Rated Output Power)

Damping Factor 60 (Front, 1 kHz, 8 Ω)

Input Sensitivity and Impedance (Unbalance)
870 mV/20 k Ω (INPUT)

Rated RCA Output Level and Impedance
0.87 V/270 Ω (OUTPUT)

Frequency Response 10 Hz - 100 kHz/+0 dB, -3 dB (INPUT)

Signal to Noise Ratio 110 dB (INPUT, IHF-A)

Speaker Impedance 4 Ω - 16 Ω

Power Supply AC 120 V, 60 Hz

Power Consumption 160 W

No-sound Power Consumption
45 W

Stand-by Power Consumption
0.5 W

Dimensions (W \times H \times D)
435 mm \times 139 mm \times 311 mm
17-1/8" \times 5-1/2" \times 12-1/4"

Weight 8.0 kg (17.6 lbs)

Specifications and features are subject to change without notice.

ONKYO

Onkyo Corporation

2-1, Nisshin-cho, Neyagawa-shi, OSAKA 572-8540, JAPAN

Tel: 072-831-8023 Fax: 072-831-8163

<http://www.onkyo.com/>

Onkyo U.S.A. Corporation

18 Park Way, Upper Saddle River, N.J. 07458, U.S.A.

Tel: 800-229-1687, 201-785-2600 Fax: 201-785-2650

<http://www.us.onkyo.com/>

Onkyo Europe Electronics GmbH

Liegnitzerstrasse 6, 82194 Groebenzell, GERMANY

Tel: +49-8142-4401-0 Fax: +49-8142-4208-213

<http://www.eu.onkyo.com/>

Onkyo Europe Electronics GmbH (UK Branch)

Unit 19, Building 6, Croxley Green Business Park, Hatters Lane, Watford, WD18 8YH, UK

Tel: +44-(0)1628-473-350 Fax: +44-(0)1628-401-700

Onkyo China Limited

Unit 1033, 10/F, Star House, No 3, Salisbury Road, Tsim Sha Tsui Kowloon, Hong Kong.

Tel: 852-2429-3118 Fax: 852-2428-9039

<http://www.onkyochina.com/>

Onkyo China PRC

1301, 555 Tower, No.555 West NanJin Road, Jin an, Shanghai,

China 200041, Tel: 86-21-52131366 Fax: 86-21-52130396

<http://www.cn.onkyo.com/>

SN 29401276

(C) Copyright 2012 Onkyo Corporation Japan. All rights reserved.

C1210-1



* 2 9 4 0 1 2 7 6 *