

**O N K Y O**

# ICON SERIES

---

*Preamplifier P-80*

Instruction Manual  
PREAMPLIFIER P-80

**En**



|   |           |  |           |
|---|-----------|--|-----------|
| <b>What's in the box</b>  | <b>4</b>  | Transmitting audio from this unit to Bluetooth wireless technology enabled devices | 25        |
| <b>Part Names</b>   | <b>5</b>  | <b>Using MY INPUT</b>  | <b>26</b> |
| Front Panel   | 6         | <b>Playing music files saved on a USB storage device</b>                           | <b>27</b> |
| Rear Panel  | 7         | <b>Using Headphones</b>  | <b>28</b> |
| Remote Controller   | 8         | <b>Spotify</b>   | <b>29</b> |
| <b>Connections</b>  | <b>9</b>  | <b>AirPlay®</b>  | <b>30</b> |
| <b>Connecting a Turntable</b>   | <b>10</b> | Basic Operations   | 30        |
| <b>Connecting a CD Player</b>   | <b>11</b> | <b>Amazon Music</b>  | <b>31</b> |
| <b>Connecting the TV</b>  | <b>12</b> | Registering This Unit with Amazon Music  | 31        |
| <b>Connecting a Power Amplifier</b>   | <b>13</b> | Playing Amazon Music using the Onkyo Controller                                    | 31        |
| Connection using an unbalanced RCA cable  | 13        | <b>TIDAL</b>   | <b>32</b> |
| Connection using a balanced XLR cable   | 14        | <b>TuneIn</b>  | <b>33</b> |
| <b>Connect the Subwoofer</b>  | <b>15</b> | Playing Back   | 33        |
| <b>Network Connection</b>   | <b>16</b> | <b>Music Server</b>  | <b>34</b> |
| <b>12V TRIGGER OUT jack</b>   | <b>17</b> | Music Server notes   | 34        |
| <b>Connecting the Power Cord</b>  | <b>18</b> | Windows Media® Player 12 settings  | 34        |
| <b>Playback</b>   | <b>19</b> | Playing Back   | 34        |
| <b>Basic Operations</b>   | <b>20</b> | <b>Setup</b>   | <b>35</b> |
| Turning the power on  | 20        | <b>Setup Flow</b>  | <b>36</b> |
| Selecting a source to play  | 20        | <b>Onkyo Controller</b>  | <b>37</b> |
| Adjusting the volume  | 21        | <b>Network settings</b>  | <b>38</b> |
| Mute  | 21        | <b>Level Calibration</b>   | <b>39</b> |
| <b>Adjusting the Bass, Treble and Balance</b>                                   | <b>22</b> | Level Calibration for Fidelity IQ  | 39        |
| <b>Using the Direct Function</b>  | <b>23</b> | <b>Measuring with Dirac Live</b>   | <b>40</b> |
| <b>Bluetooth® Playback</b>  | <b>24</b> | Using Dirac Live   | 41        |
| Playing audio from Bluetooth wireless technology enabled devices with this unit | 24        | <b>Firmware Update</b>   | <b>42</b> |

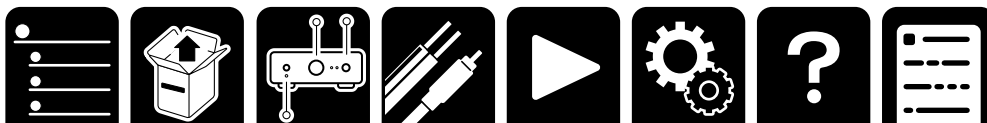

|   |           |
|---|-----------|
| <b>Settings Affecting Power Consumption and Standby Power</b> | <b>43</b> |
| <b>Web Setup</b>  | <b>44</b> |
| Menu operations   | 44        |
| <b>Troubleshooting</b>  | <b>45</b> |
| <b>General Specifications</b>                                 | <b>47</b> |
| North America and Japan models                                | 47        |
| Europe models   | 48        |
| Asia and Oceania models                                       | 49        |
| Common to all destinations                                    | 50        |
| License and Trademark   | 51        |

### Supplementary Information

Features, etc. released in firmware updates



### Settings Affecting Power Consumption and Standby Power

( →[p43](#))



# What's in the box

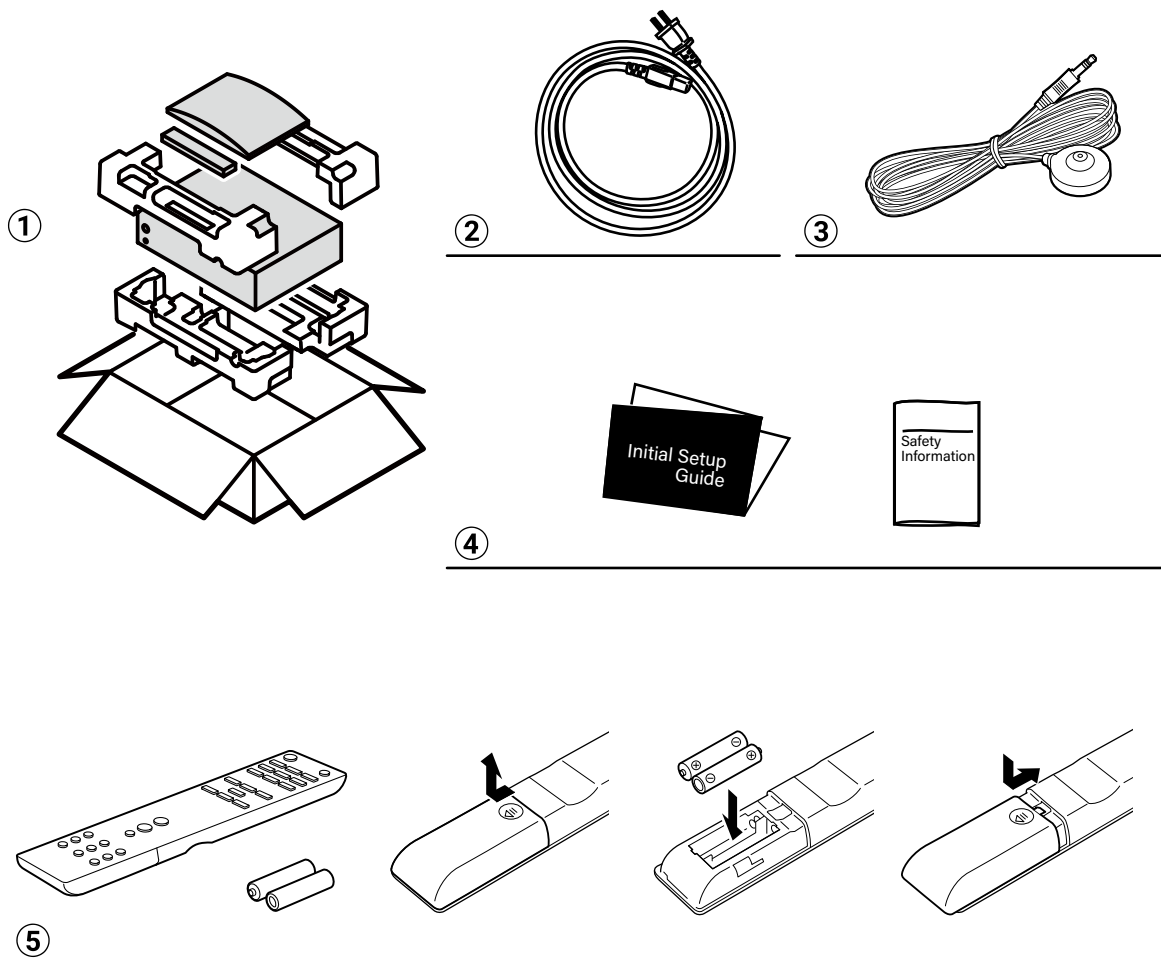

- ① **Main unit**
- ② **Power cord (1)** \*Depending on the model, 2 or more Power Cords are supplied. Use the type of cord suited to your area.
- ③ **Speaker setup microphone**
- ④ **Initial Setup Guide, Safety Information**
- ⑤ **Remote controller(RC-991S) (1)**  
**Batteries (AAA/R03) (2)** (Some models only)

\* This is an online user manual. This is not supplied with the product.



|                   |   |
|-------------------|---|
| Front Panel       | 6 |
| Rear Panel        | 7 |
| Remote Controller | 8 |

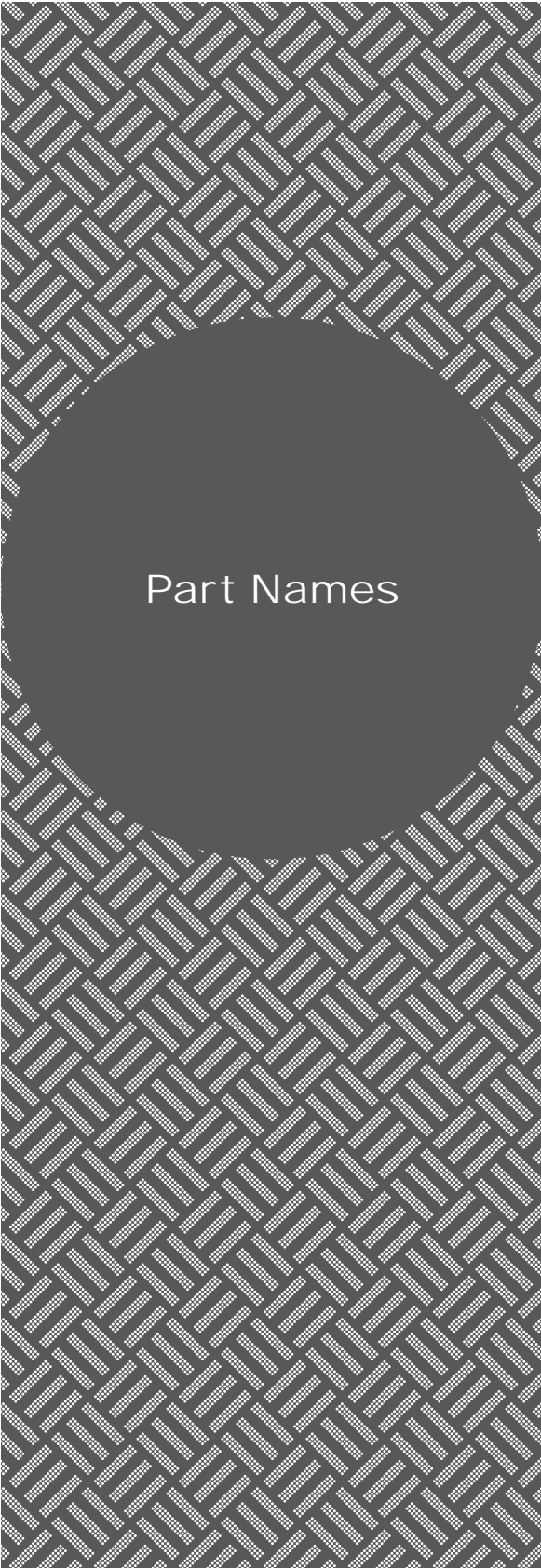

# Front Panel

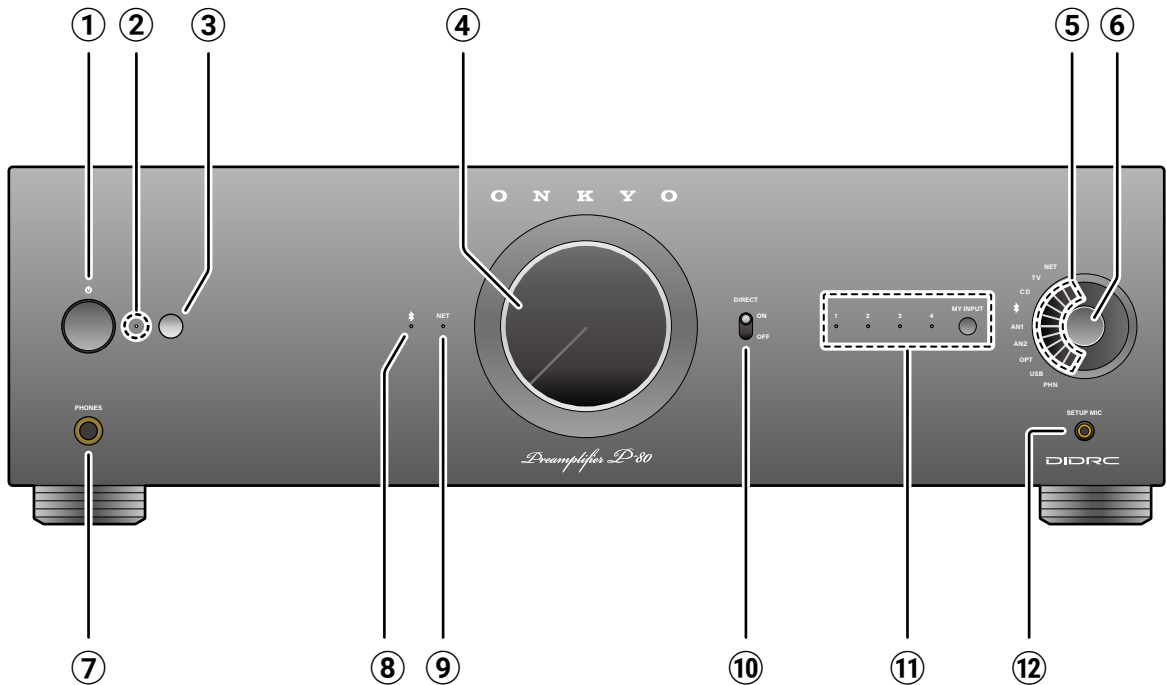

① ON/STANDBY button ( →p20)

② Power indicator

③ Remote control sensor

④ MASTER VOLUME ( →p21)

⑤ Selector indicator

⑥ Selector knob ( →p20)

⑦ PHONES jack ( →p28)

⑧ BLUETOOTH indicator ( →p24)

⑨ NET indicator

• When the main unit is connected to the network, the status of this indicator changes from blinking to lighting.  
When the network standby function ( →p43) is enabled, this indicator is lit even in the standby mode.

⑩ DIRECT switch ( →p23)

⑪ MY INPUT indicator ( →p26)

MY INPUT button ( →p26)

⑫ SETUP MIC jack ( →p40)



## Rear Panel

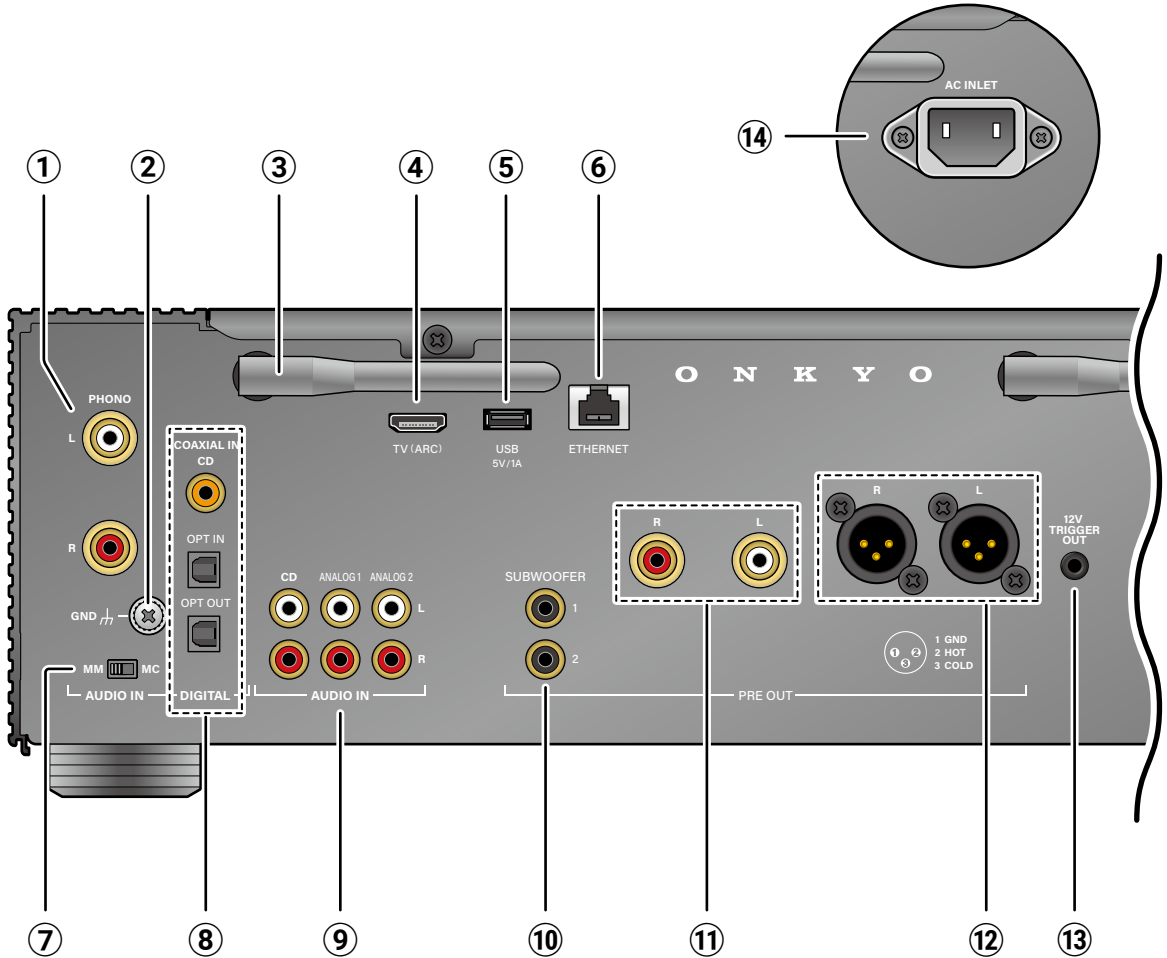

- ① PHONO jacks ( →p10)
- ② GND terminal ( →p10)
- ③ Wireless antenna
- ④ HDMI ARC terminal ( →p12)
- ⑤ USB port ( →p27)
- ⑥ ETHERNET port ( →p16)
- ⑦ MM/MC selector switch ( →p10)
- ⑧ Digital terminals ( →p11)
  - Digital coaxial input terminal ×1
  - Digital optical input terminal ×1
  - Digital optical output terminal ×1
- ⑨ AUDIO IN jacks ( →p11)
- ⑩ SUBWOOFER PRE OUT jacks
- ⑪ PRE OUT L/R jacks (unbalanced RCA output terminal)
- ⑫ PRE OUT L/R jacks (balanced XLR output terminal)
- ⑬ 12V TRIGGER OUT jack ( →p17)
- ⑭ AC IN terminal ( →p18)



# Remote Controller

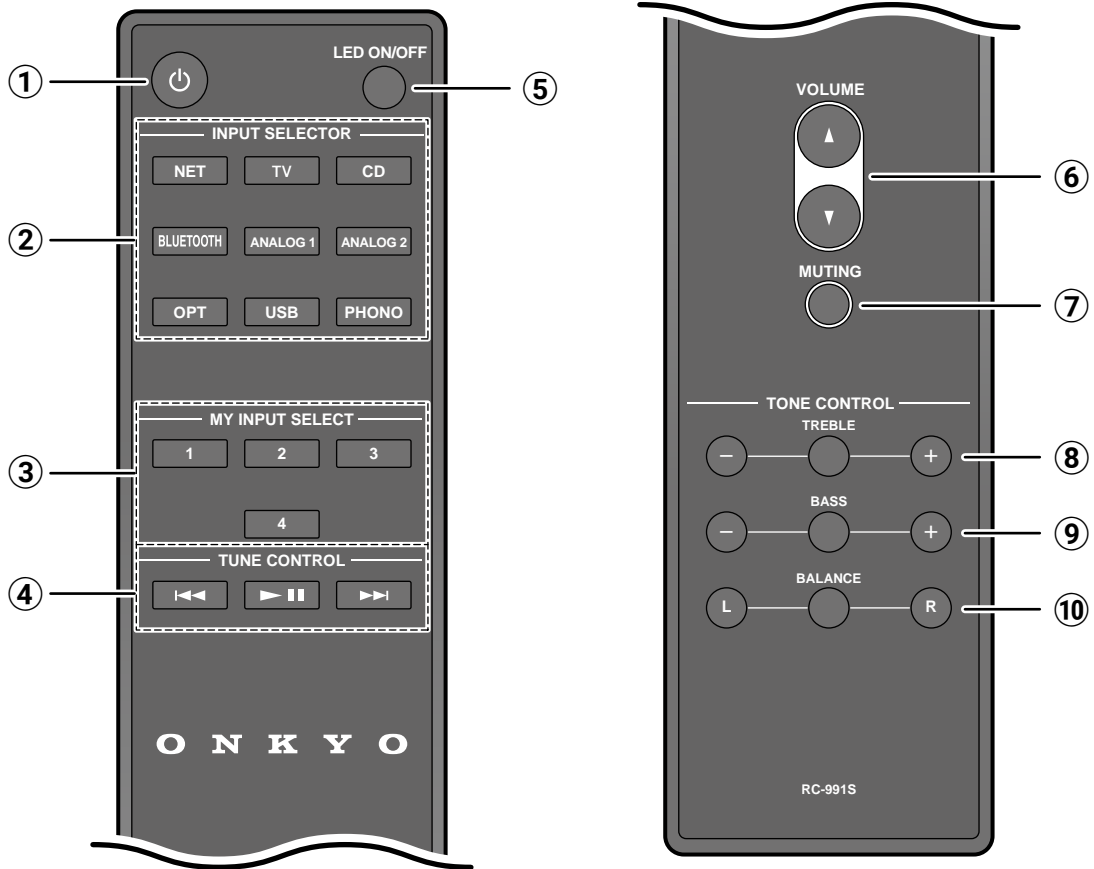

- ① ON/STANDBY button ( → [p20](#) )
- ② Input selector buttons ( → [p20](#) )
- ③ MY INPUT 1/2/3/4 buttons ( → [p26](#) )
- ④ TUNE CONTROL buttons
- ⑤ LED ON/OFF button
- ⑥ Volume buttons ( → [p21](#) )
- ⑦ MUTE button ( → [p21](#) )
- ⑧ TREBLE +/- buttons ( → [p22](#) )
- ⑨ BASS +/- buttons ( → [p22](#) )
- ⑩ BALANCE L/R buttons ( → [p22](#) )



|                              |    |
|------------------------------|----|
| Connecting a Turntable       | 10 |
| Connecting a CD Player       | 11 |
| Connecting the TV            | 12 |
| Connecting a Power Amplifier | 13 |
| Connect the Subwoofer        | 15 |
| Network Connection           | 16 |
| 12V TRIGGER OUT jack         | 17 |
| Connecting the Power Cord    | 18 |

**Note**

- The illustration of the power amplifier uses M-80, the separately sold ONKYO power amplifier. When connecting another power amplifier, also check the instruction manual of the equipment to be connected.

## Connections



# Connecting a Turntable

1. Remove the short pin (a), and connect the cable of the turntable.
  - If your turntable has a built-in phono preamp, you can connect the turntable to other analog inputs such as **ANALOG 1**.
  - If your turntable has a ground wire, connect it to the **GND** screw (b). With some turntables, connecting the ground wire may produce an audible hum. If this happens, disconnect it.
2. According to the type of cartridge of the turntable, switch between MM and MC.

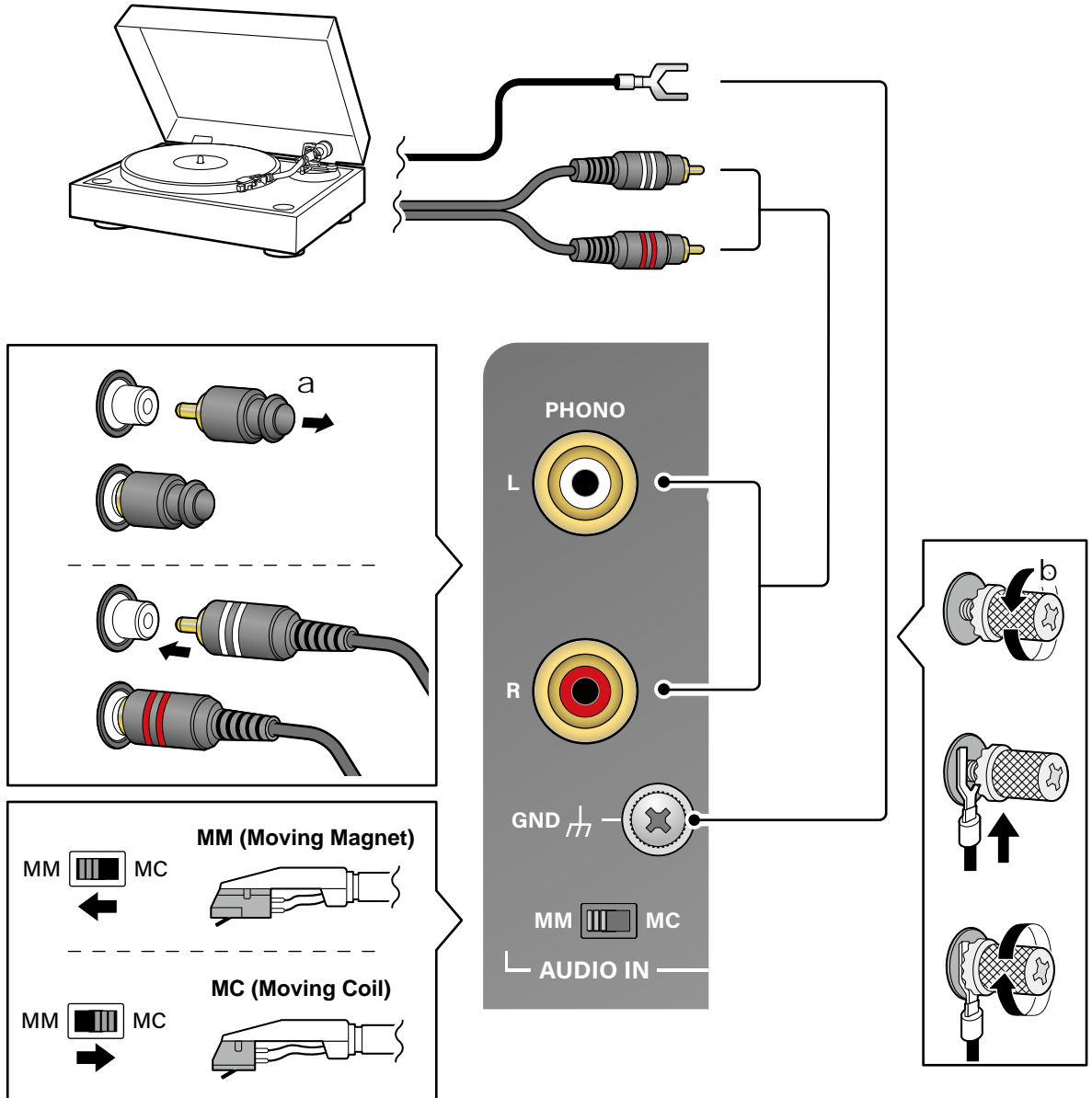

## Connecting a CD Player

Connect a CD player using an analog cable or digital cable (digital optical cable or digital coaxial cable).

### Note

DAC (Digital Analog converter) to be used differs depending on the connection method. DAC is an electronic circuit that converts digital signals to analog signals (audio).

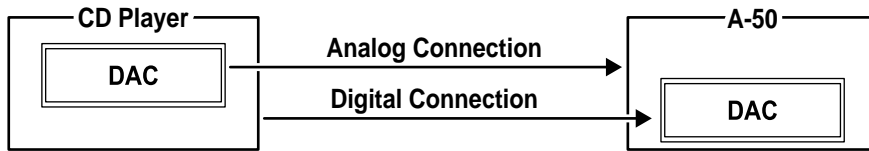

### ■ Analog Connection

Connect the CD Player to either of the following jacks: AUDIO IN (CD, ANALOG 1, ANALOG 2).

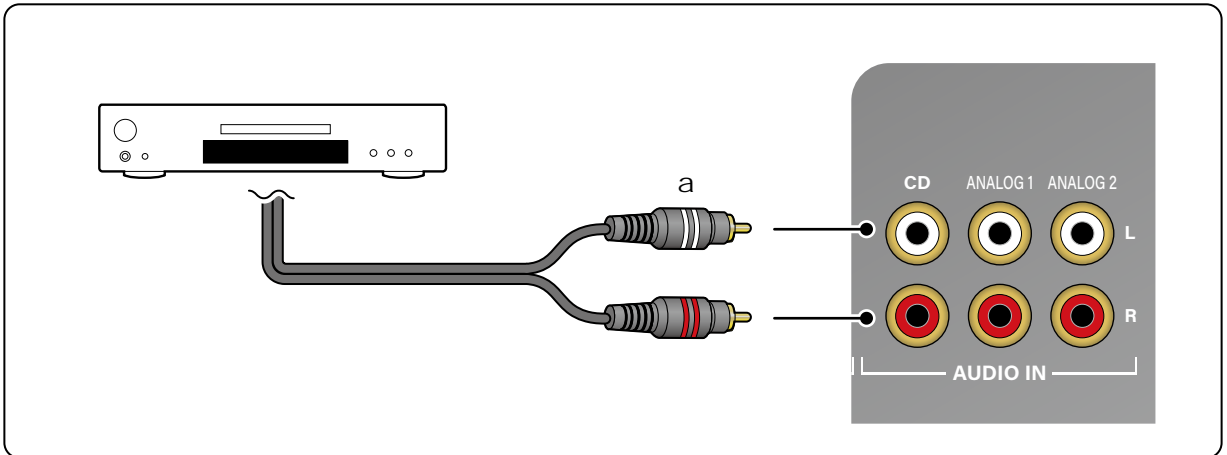

a Analog audio cable

### ■ Digital Connection (Coaxial or Optical)

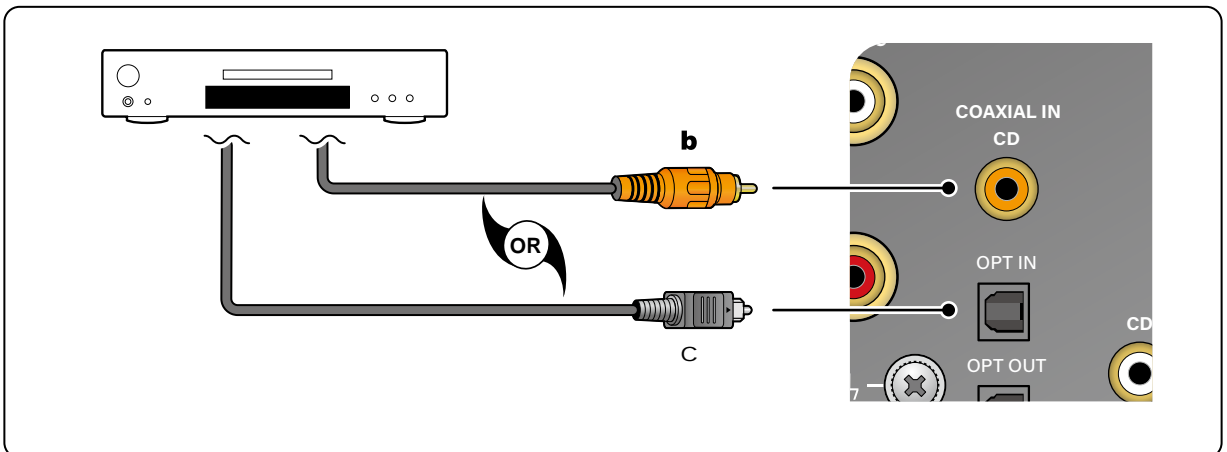

b Digital coaxial cable, c Digital optical cable

• When audio is input into the AUDIO IN COAXIAL CD jack, the audio of the AUDIO IN CD jack is turned off.



## Connecting the TV

### ■ To ARC TV

If the TV supports the ARC (Audio Return Channel) function(\*), use only the HDMI cable to connect with the TV. Use the ARC-compatible HDMI IN jack of the TV for connection.

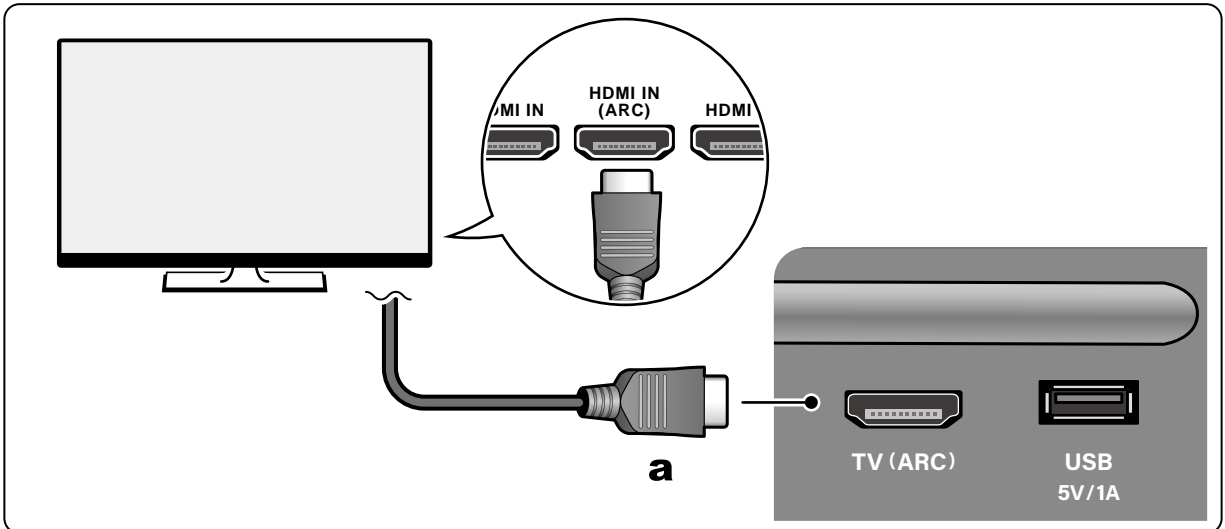

a HDMI cable

### **Note**

When the audio of the TV is not reproduced from the speakers connected to this unit, check that the audio output destination is set to an external device on the ARC setting of the TV. Also, check that the HDMI cable supports the ARC.

### ■ To Non-ARC TV

When the TV does not support the ARC (Audio Return Channel) function(\*), connect a digital optical cable.

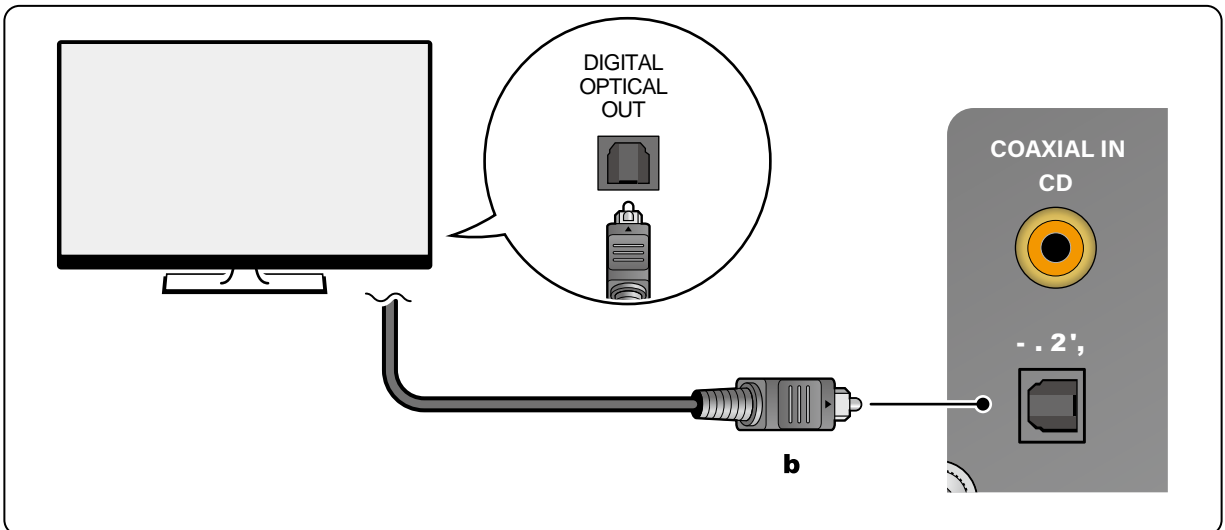

b Digital optical cable

(\* ) The ARC function transmits audio signals of a TV via an HDMI cable to reproduce the audio of the TV on this unit. To check if the TV supports the ARC function, see the instruction manual of the TV or relevant documents.



# Connecting a Power Amplifier

## Connection using an unbalanced RCA cable

An unbalanced RCA cable (a) is a typical analog audio cable widely used for connection of audio equipment.

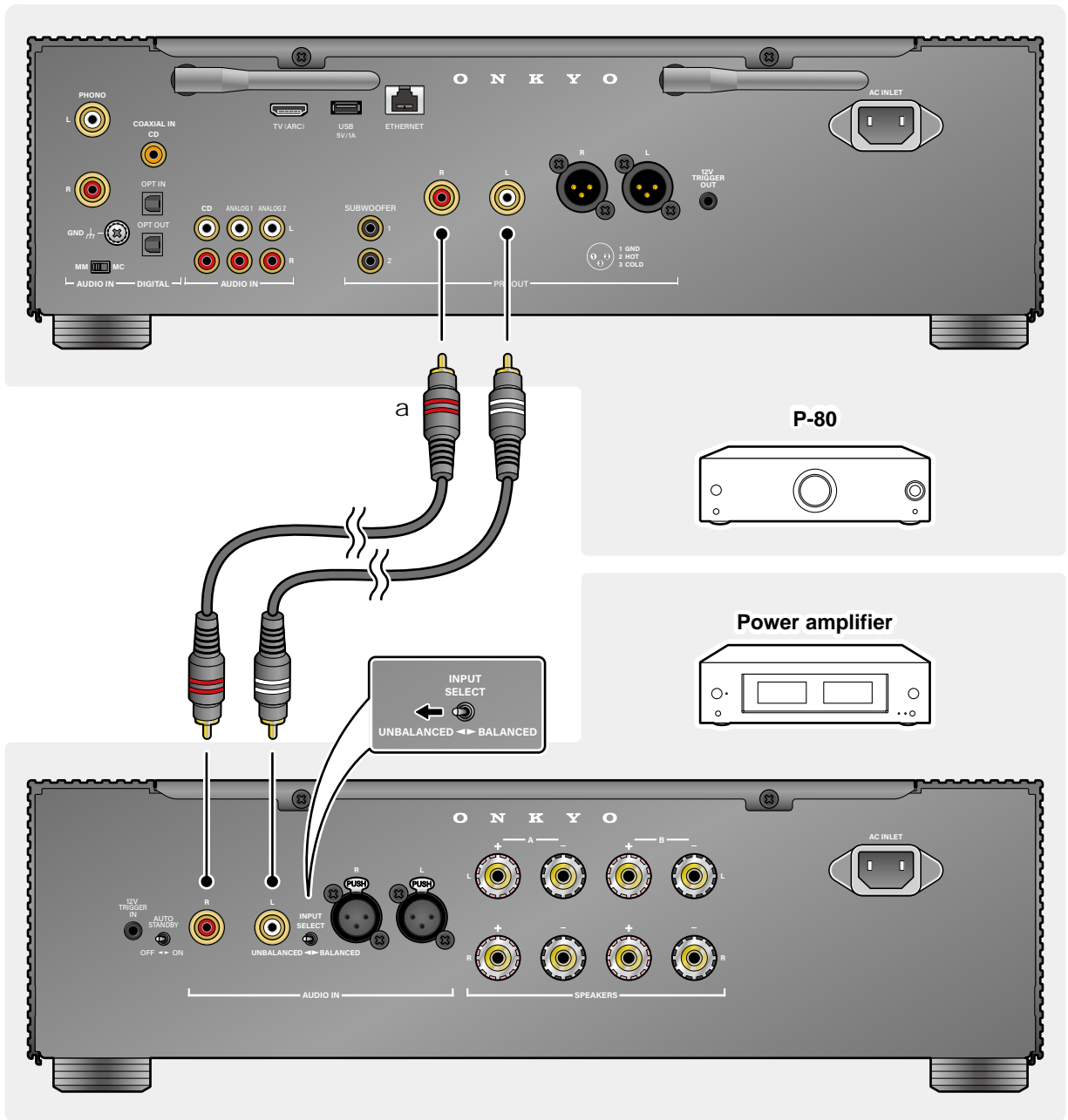

## Connection using a balanced XLR cable

A balanced XLR cable (a) attenuates audio signals less than an unbalanced RCA cable, minimizing noise. This cable is suited when a long cable is required to connect to equipment remotely located.

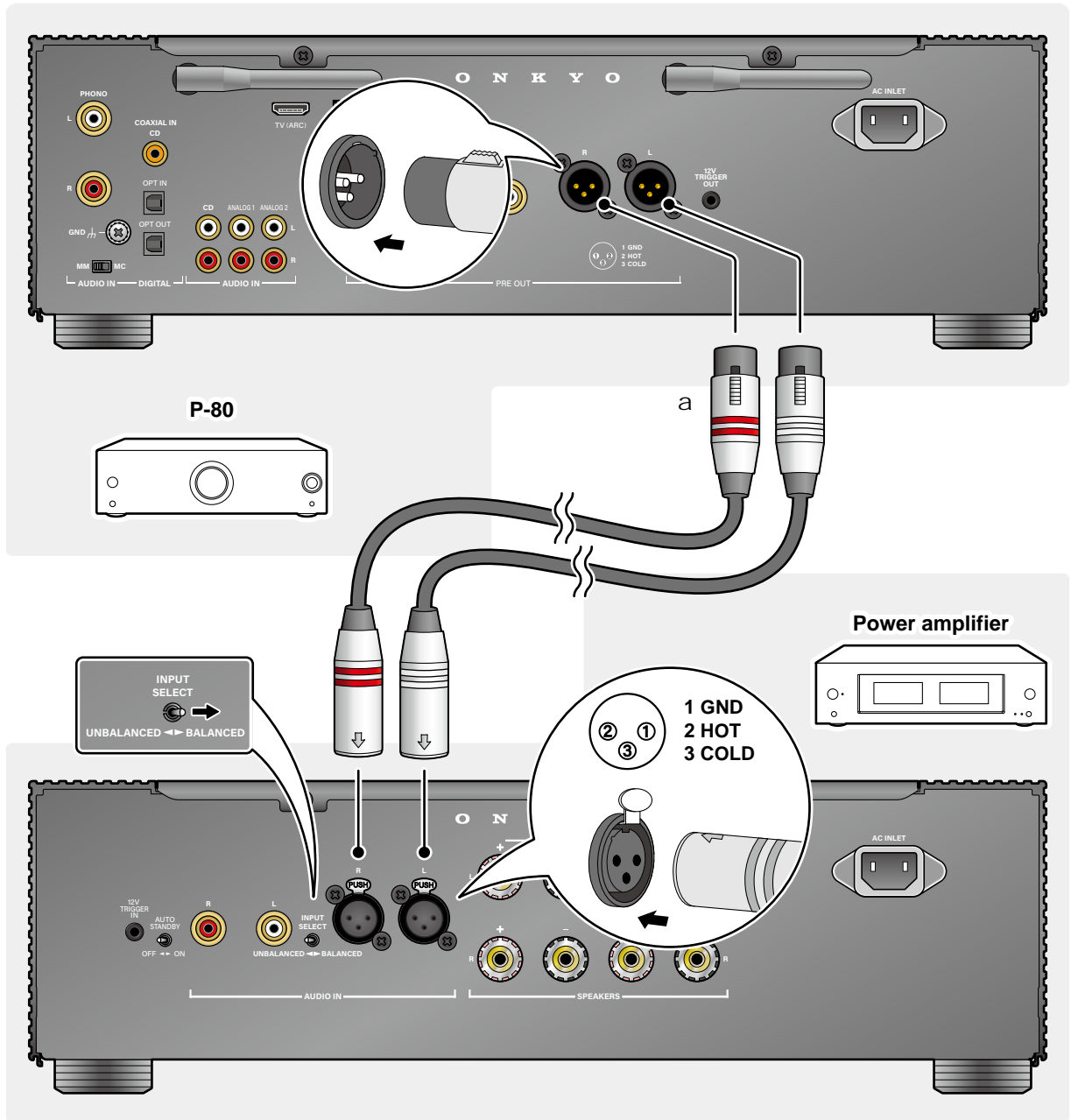

• To remove the XLR cable from this unit, press and hold the connector button (b), and pull the cable.

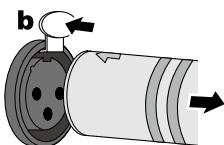

## Connect the Subwoofer

Connect a powered subwoofer with this unit using a subwoofer cable. Up to two powered subwoofers can be connected. The same signal is output from each SUBWOOFER PRE OUT jack.

### Note

Configure the setting to use the subwoofer. Download Onkyo Controller ( →[p37](#) ), select "Speaker Settings" - "Subwoofer" on the menu screen, and select "1ch" or "2ch".

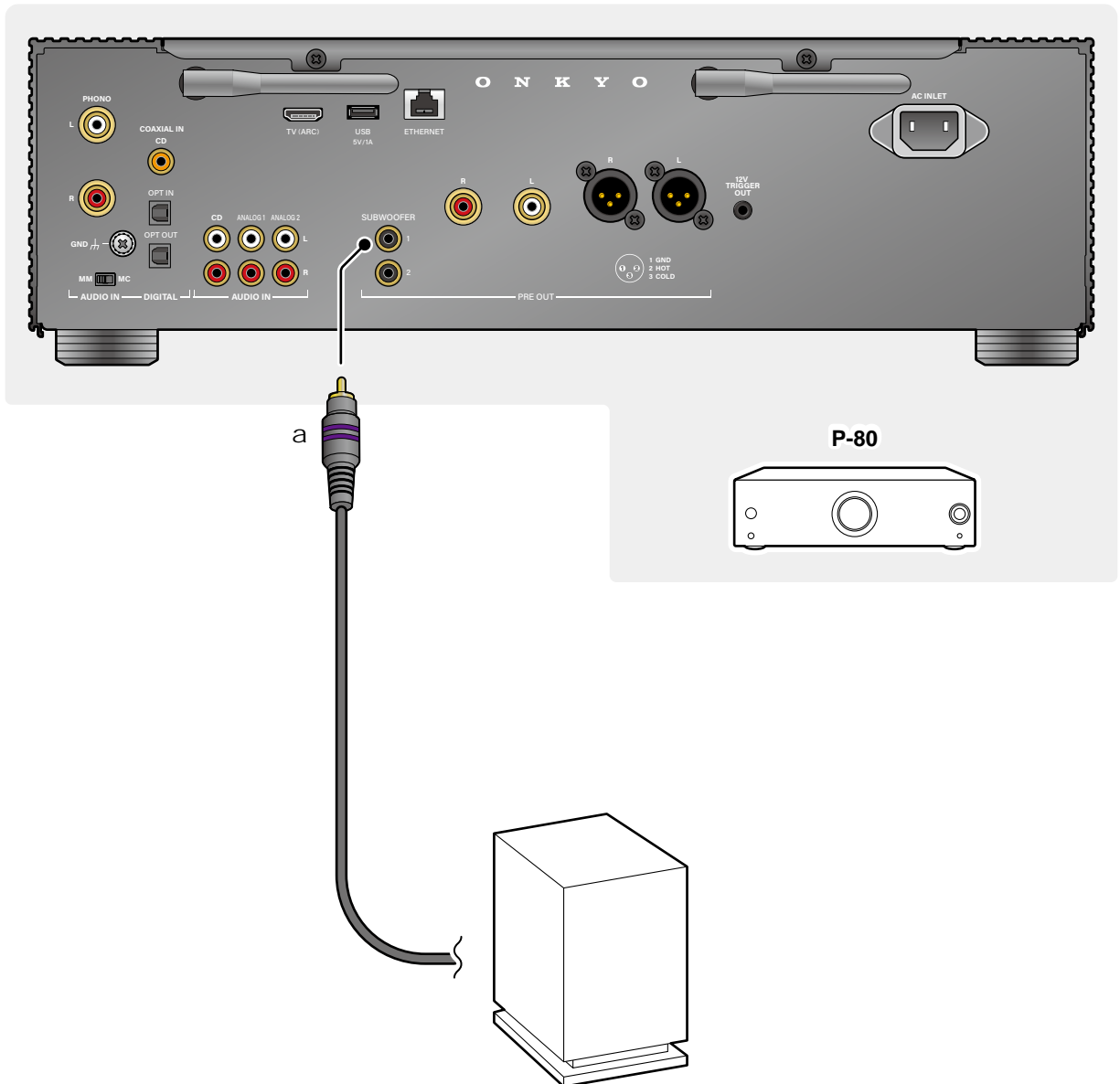

## Network Connection

This unit can be connected to the network using a wired LAN or Wi-Fi (wireless LAN).

Connecting to the network enables playback of an Internet radio, or various operations and settings using Onkyo Controller ( →p37). If connection is made by the wired LAN, connect the router and the ETHERNET jack with the Ethernet cable as shown in the illustration. If connection is made via Wi-Fi, stand the wireless antenna on the rear side, install Onkyo Controller on the mobile device, and configure the setting according to the on-screen instruction.

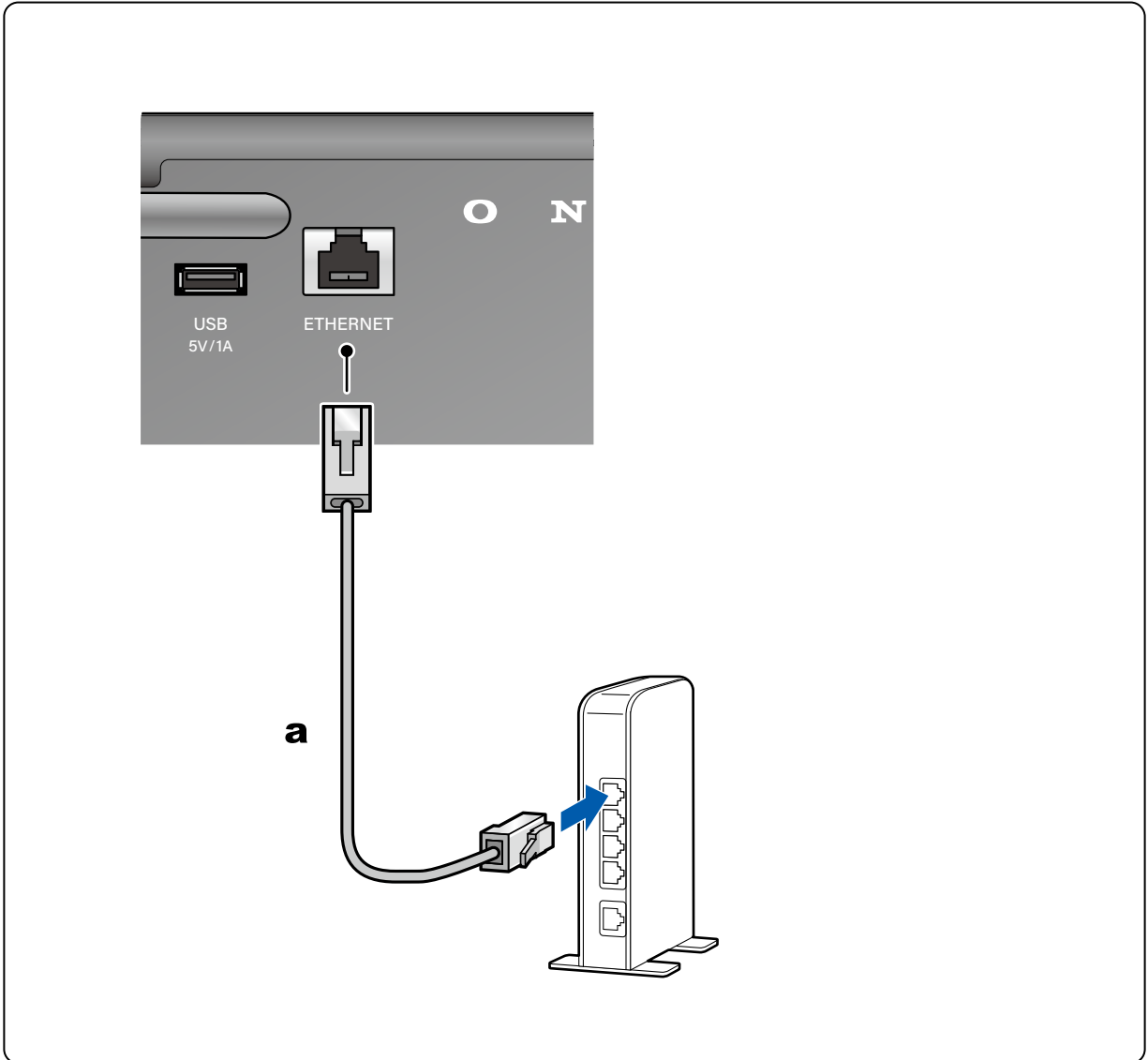

a Ethernet cable

### Note

For security reasons, always connect via a router, etc., when connecting this unit to the Internet. Do not directly connect to the communication circuits (including public wireless LAN) of a telecommunications provider (mobile communications company, fixed-line communications company, Internet provider, etc.).



## 12V TRIGGER OUT jack

When connecting a device equipped with a TRIGGER IN jack such as a power amplifier to this unit, the device can be turned on or set to standby by interlocking the operation on this unit.

- Use the supplied monaural mini-plug cable (a) for connection.
- When using a commercially available cable, use a monaural mini-plug cable ( $\phi 3.5$  mm) without resistance. Do not use a stereo mini-plug cable.

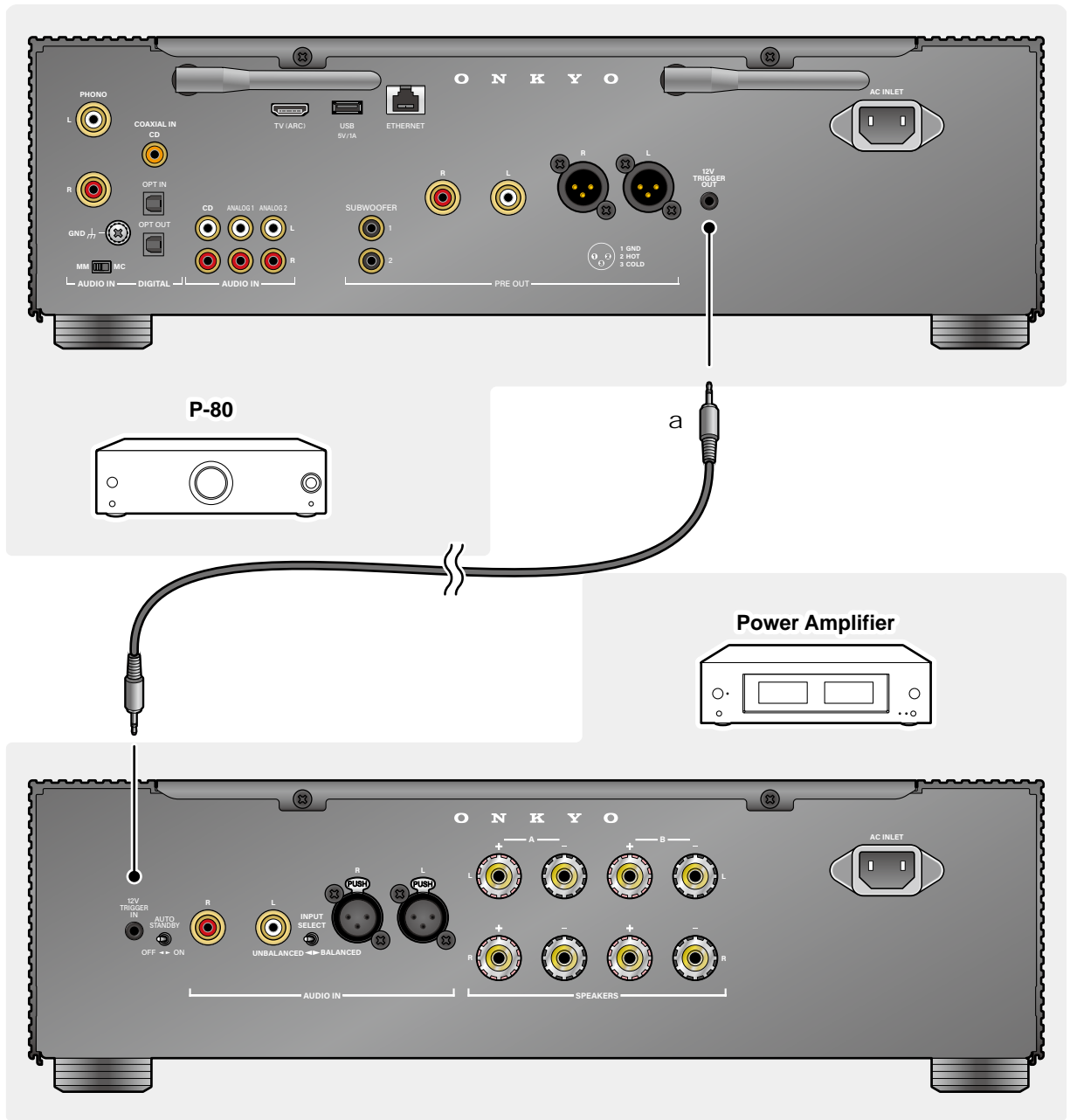

## Connecting the Power Cord

Connect the power cord after all the connections are completed.

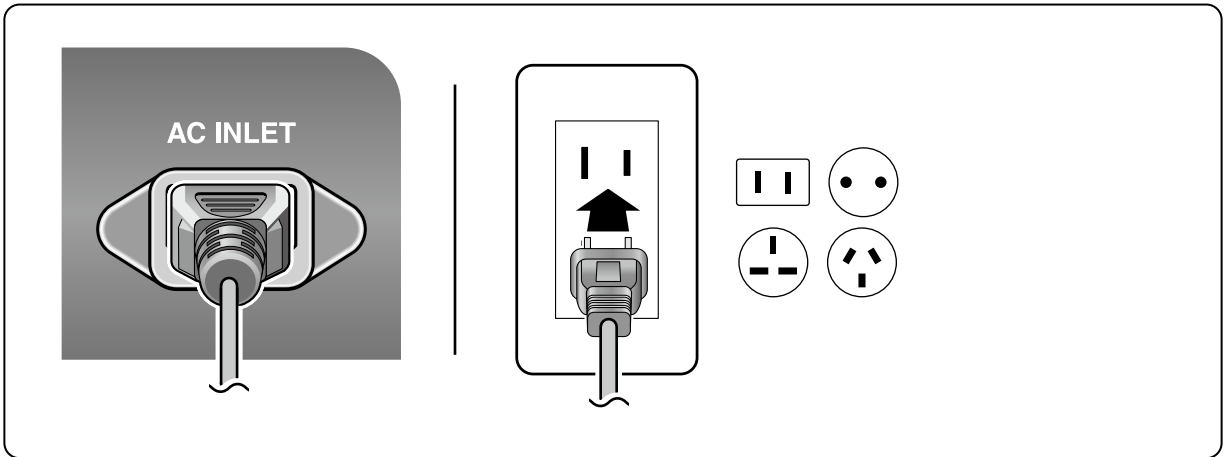

### Note

Japan model: Adapt the power source polarity for enhancement of the sound quality. Align the N-printed side of the power plug supplied with this unit with the longer groove of the outlet, and insert the power plug. If both grooves of the outlet are the same in length, either side can be connected.

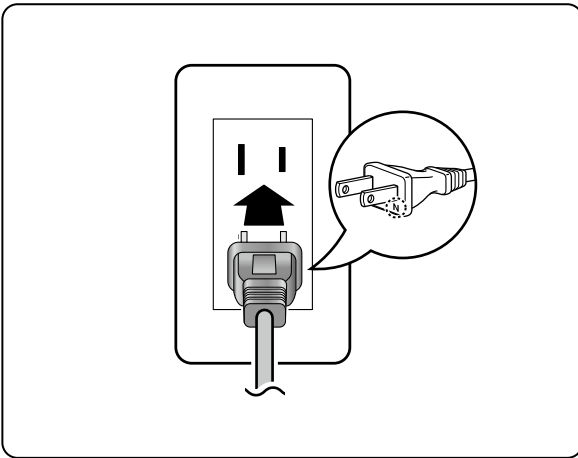

## Basic Operations

|   |    |
|---|----|
| Basic Operations                                  | 20 |
| Adjusting the Bass, Treble and Balance            | 22 |
| Using the Direct Function                         | 23 |
| Bluetooth® Playback                               | 24 |
| Using MY INPUT                                    | 26 |
| Playing music files saved on a USB storage device | 27 |
| Using Headphones                                  | 28 |

## Network Services

|              |    |
|--------------|----|
| Spotify      | 29 |
| AirPlay®     | 30 |
| Amazon Music | 31 |
| TIDAL        | 32 |
| TuneIn       | 33 |
| Music Server | 34 |

**Note**

To use the network service, Onkyo Controller (→[p37](#)) is necessary.

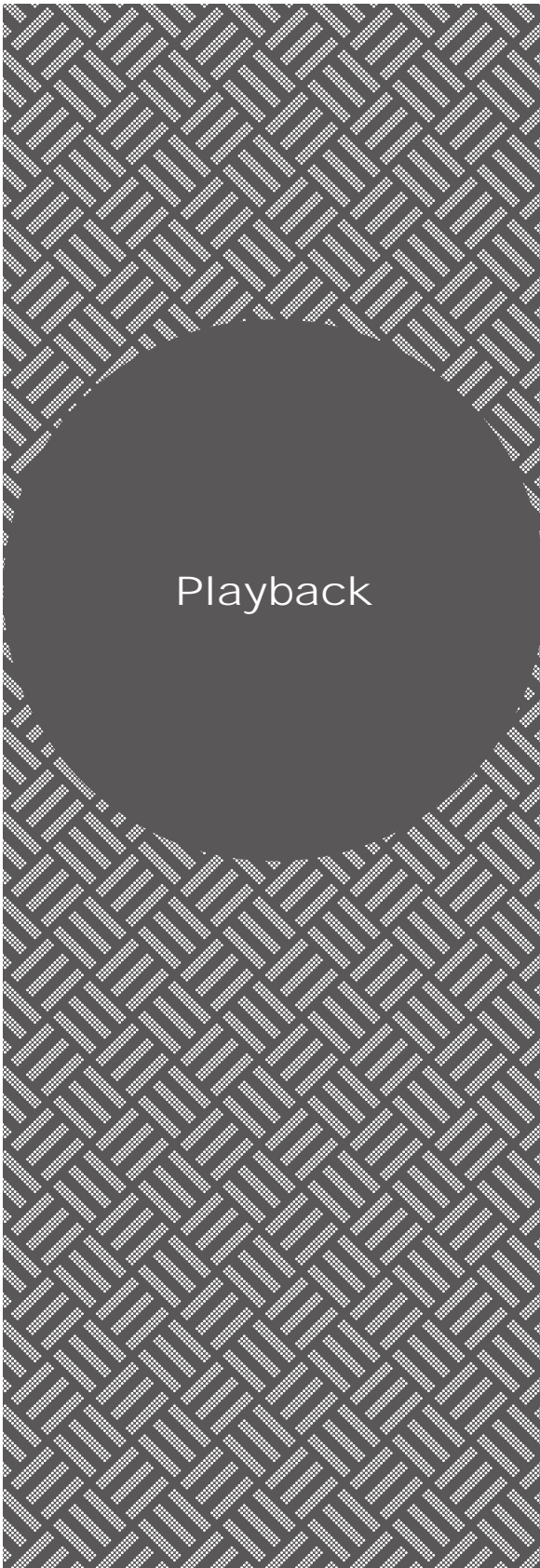

## Basic Operations

### Turning the power on

1. Press  ON/STANDBY on the remote controller to turn on the power of the unit.

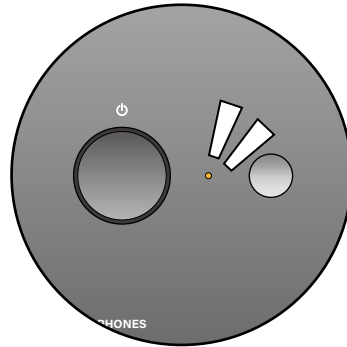
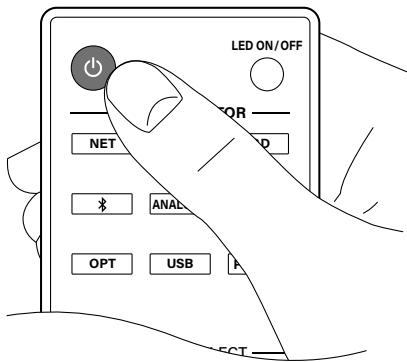

You can also turn on the power of the unit with the following operations:

- Pressing  ON/STANDBY on the main unit.
- Using the Onkyo Controller ( → [p37](#) )

### Selecting a source to play

1. Press an input selector button on the remote controller to select a source.

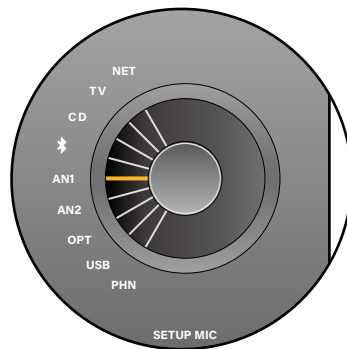
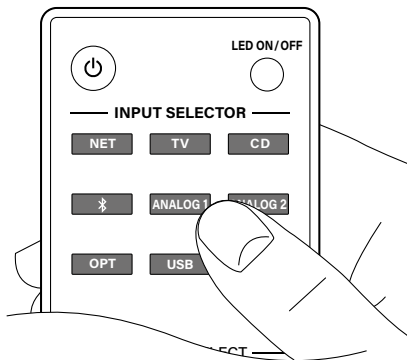

You can also select a source to play with the following operations:

- Turn the selector knob of the main unit.
- Using the Onkyo Controller ( → [p37](#) )



## Adjusting the volume

---

1. Press the VOLUME buttons on the remote controller to adjust the volume.

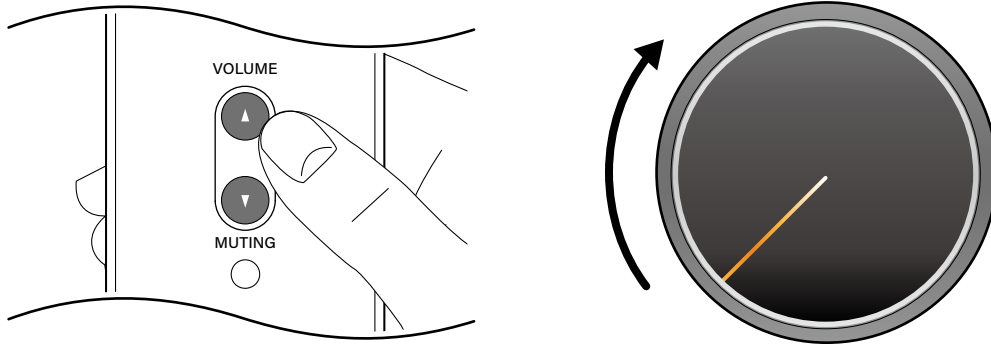

You can also adjust the volume with the following operations:

- Using the VOLUME dial on the main unit
- Using the Onkyo Controller ( → [p37](#) )

## Mute

---

1. To temporarily turn off the sound, press the MUTING button. Press again to cancel.
  - In the muting state, the volume indicator slowly blinks.

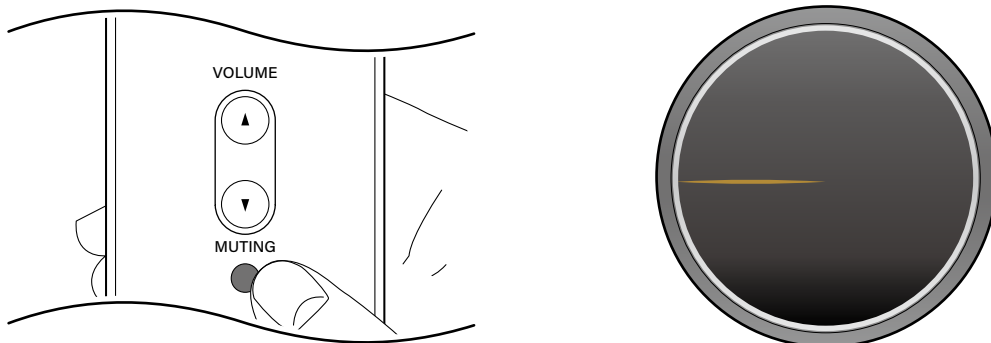

You can also adjust the volume with the following operations:

- Using the Onkyo Controller ( → [p37](#) )



## Adjusting the Bass, Treble and Balance

You can adjust the bass, treble and left/right output balance respectively.

**TREBLE:** Enhance or moderate the high pitched range.

**BASS:** Enhance or moderate the low pitched range.

**BALANCE:** Adjust the balance of the sounds output from the left and right speakers.

• When the DIRECT function ( →[p23](#)) is turned on, "TREBLE" and "BASS" are disabled.

1. Press the TONE CONTROL button ("TREBLE" or "BASS" or "BALANCE") of the remote controller once.
  - When the adjustment is made for the first time, the indicator of "AN 1" as the point of origin ( $\pm 0$ ) blinks.

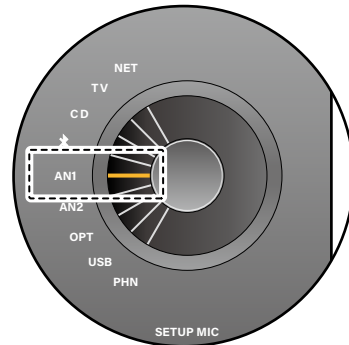
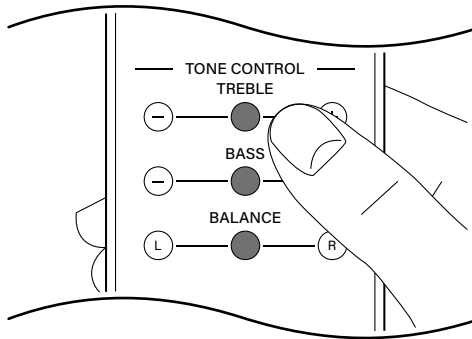

2. Press the "+/-" button or "L/R" button to adjust the level.

The level can be adjusted in 10 stages. TREBLE and BASS can be adjusted up to +10 or -10. BALANCE can be adjusted up to +10 on the R side, or +10 on the L side. When the level adjustment reaches the upper limit, all displayed indicators blink.

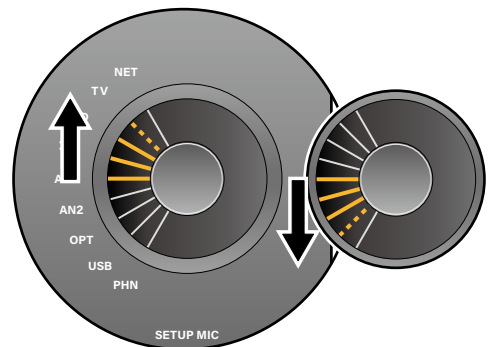
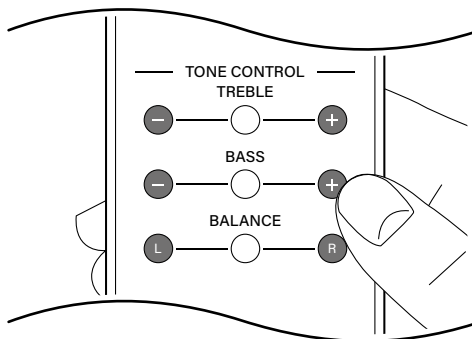

TREBLE, BASS, and BALANCE can also be set using the following operation.

– Using the Onkyo Controller ( →[p37](#))



## Using the Direct Function

When the DIRECT function is turned on, the sound does not pass through the Tone Control circuit that adjusts treble and bass, but passes through the shortest route in favor of sound quality. The output balance between right and left can be adjusted since it uses a method that does not affect the sound quality.

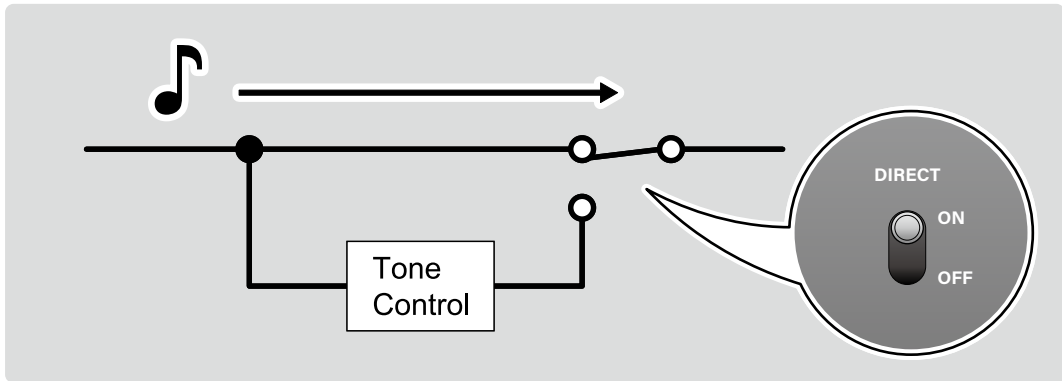

## Bluetooth® Playback

You can wirelessly play music on a smartphone or other Bluetooth wireless technology enabled device through the speakers connected to this unit. It is also possible to transmit the audio from this unit to Bluetooth enabled headphones, wireless speakers, etc.

### Playing audio from Bluetooth wireless technology enabled devices with this unit

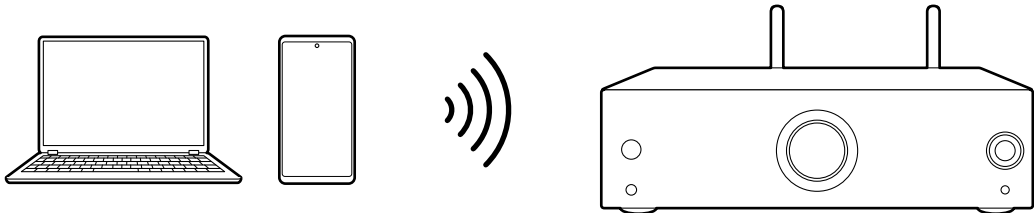

#### ■ Pairing

1. Press the ON/STANDBY button to turn on the unit.
2. Press the BLUETOOTH button to switch to the BLUETOOTH selector. The BLUETOOTH indicator blinks, and the unit enters the pairing standby state.
  - When the BLUETOOTH-enabled device is already connected, the unit enters the pairing standby state again by canceling the connection or pressing and holding the selector knob of this unit for a few seconds.

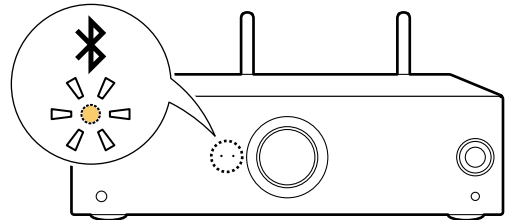
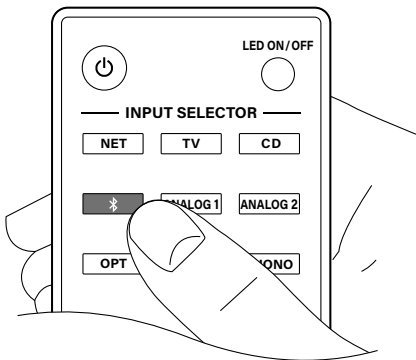

3. Turn on the BLUETOOTH function of the BLUETOOTH-supported device.
4. Operate the BLUETOOTH-enabled device, and select this unit. When the pairing is successful, the BLUETOOTH indicator status changes from blinking to lighting.

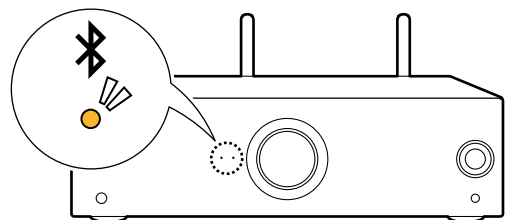
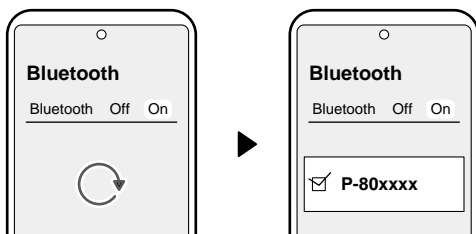

- When multiple BLUETOOTH-enabled devices are connected, the unit needs to be put into the pairing standby state again.

Set the input source to "Bluetooth" and then press and hold the selector tab for a few seconds. Then the BLUETOOTH indicator blinks, and the unit enters the pairing standby state.



## Transmitting audio from this unit to Bluetooth wireless technology enabled devices

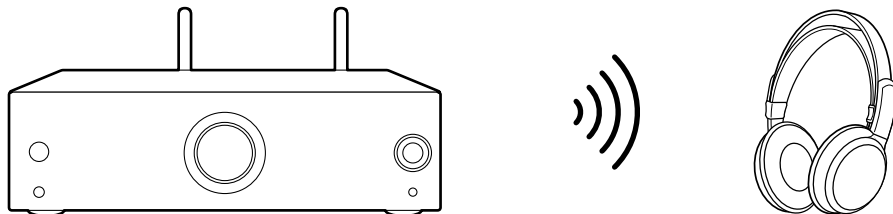

### ■ Pairing

To use this feature, the Onkyo Controller is required.

1. Launch the Onkyo Controller, select " ⋮ " - "Bluetooth Transmitter", and select either "On (Tx)" or "On (Main + Tx)" in "Bluetooth Transmitter". (Default value is "Off")
2. The search for available Bluetooth-enabled devices begins, and compatible devices will be displayed in a list. Select the device you wish to output audio to and perform pairing.
  - Depending on the Bluetooth wireless technology enabled device, you may need to pair manually. If the device name does not appear in the list, check the settings of the Bluetooth wireless technology enabled device.

### Note

- You cannot transmit audio to multiple Bluetooth wireless technology enabled devices from this unit.
  - The coverage area is approx. 48 ~ /15 m. Note that connection is not always guaranteed with all Bluetooth enabled devices.
  - Audio cannot be output from a Bluetooth wireless technology enabled device in the following cases:
    - When the audio file is DSD format
    - When playing audio from one of the following network services: Chromecast built-in, Amazon Music, AirPlay, Qobuz Connect, Roon Ready
- \*The services may not be available, depending on your area of residence.



## Using MY INPUT

Up to four settings such as the current input source, sound adjustment, and Network Service (for NET selector) can be registered to MY INPUT, and the registered settings can be invoked easily.

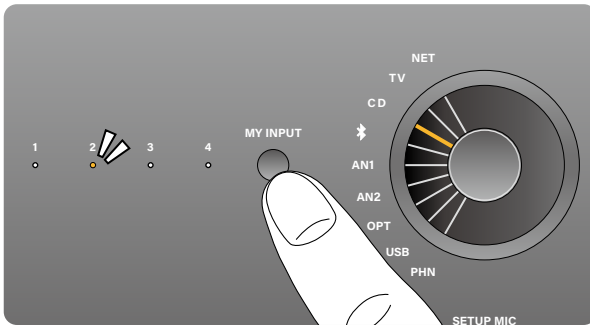

MY INPUT registration is performed on the main unit.

1. Press and hold the MY INPUT button for a few seconds. When the indicator blinks, release your finger.
2. Press the MY INPUT button repeatedly, and select a registration destination for the setting from among 1 to 4.
3. Press and hold the MY INPUT button. When the indicator status changes from blinking to lighting, the registration is complete.

Content is overwritten if there was any already registered.

- Onkyo Controller ( → [p37](#) ) can also be used to perform MY INPUT registration or invoke settings. Also, the settings registered on MY INPUT can be checked.

### Regarding the settings that can be registered

- Input Selector
- Volume level ("82" is the upper limit)
- BASS, TREBLE, VOCAL/Dialog, BALANCE, Fidelity IQ
- Network Service
  - Spotify, TuneIn, Amazon Music



## Playing music files saved on a USB storage device

Using Onkyo Controller ( →[p37](#)) allows music files stored on the USB storage device to be played.

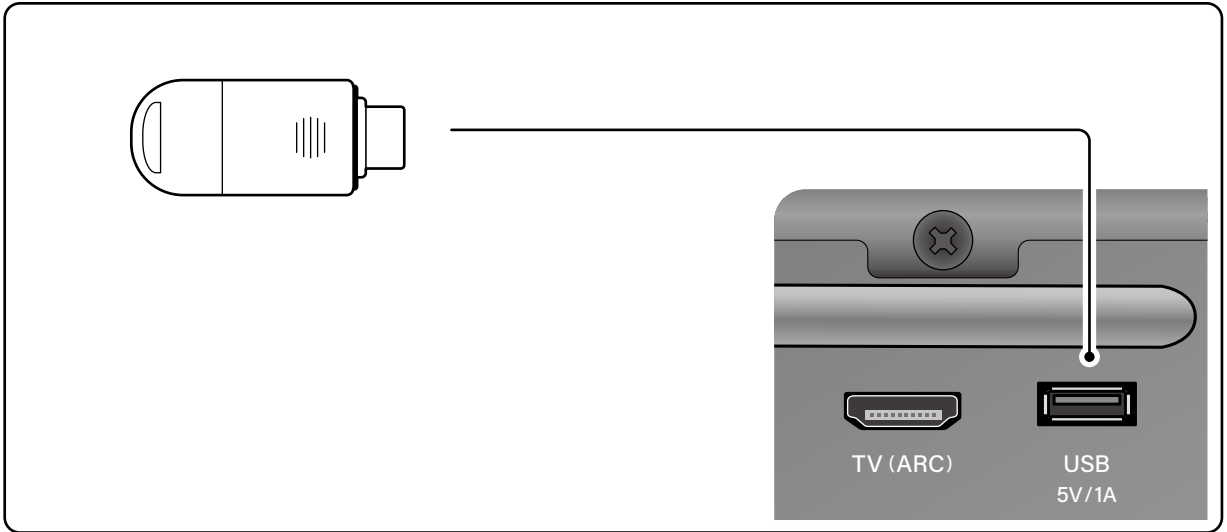

• Supported Audio Formats ( →[p50](#))



## Using Headphones

This unit supports headphones with the standard plug (6.3 mm).

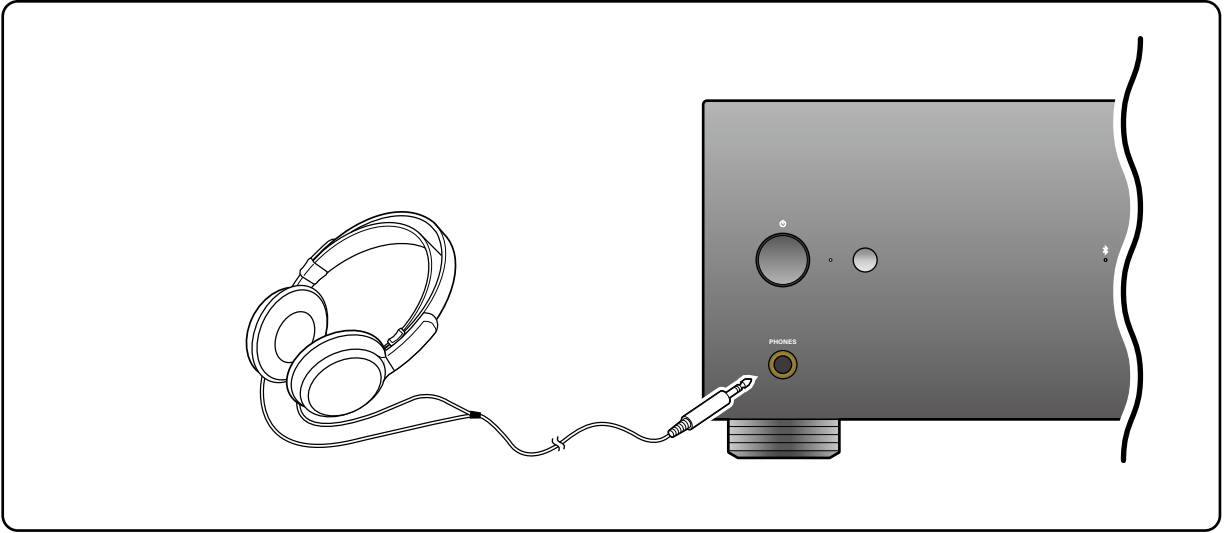

- While headphones are connected, no sound is output from the speakers and PRE OUT jacks.
- When headphones are used, the right and left balance adjustment is disabled.



# Spotify



Use your phone, tablet or computer as a remote control for Spotify.  
Go to [spotify.com/connect](https://spotify.com/connect) to learn how.

The Spotify software is subject to third party licenses found here:  
<https://www.spotify.com/connect/third-party-licenses>



## AirPlay®

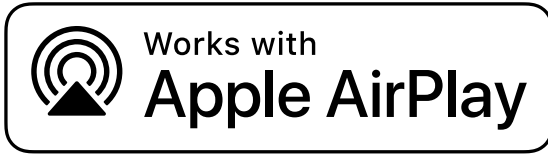

By connecting this unit to the same network as that of iOS devices such as iPhone®, iPod touch® and iPad®, you can enjoy music files on iOS devices wirelessly.

- Depending on the iOS version, operation screens or operation procedures on the iOS device may be different. For details, refer to the operating instructions for the iOS device.

## Basic Operations

---

1. Connect the iOS device to the access point where this unit is connected via network.
2. Tap the AirPlay icon  in the play screen of the music app on an iOS device that supports AirPlay and select this unit from the list of devices displayed.
3. Play the music file on the iOS device.
  - Due to the characteristics of AirPlay wireless technology, the sound produced on this unit may slightly be behind the sound played on the AirPlay-enabled device.

### Note

- AirPlay and AirPlay2 allow for playback of music files stored on a PC with iTunes (Ver. 12.8 or later) installed. Click the AirPlay icon  of iTunes, select this unit and an AirPlay or AirPlay2-enabled device to play from the displayed devices, and play a music file.
- Due to the characteristics of AirPlay wireless technology, the sound produced on this unit may slightly be behind the sound played on the AirPlay-enabled device.



# Amazon Music



Registering this unit with Amazon Music allows you to enjoy the music distribution service provided by Amazon.

- To play Amazon Music, you need to have your Amazon account and sign up for Amazon Prime or Amazon Music Unlimited. For more information, see the Amazon website.

Amazon Music is now available in several countries. If Amazon Music is not available in your country, please visit <https://music.amazon.com/> for more info.

## Registering This Unit with Amazon Music

1. Register with the Amazon account on Onkyo Controller ( → [p37](#)). This cannot be set with operations on this unit.
2. Start Onkyo Controller and tap the unit when displayed.
3. Operate Onkyo Controller, and switch to the NET selector. Then tap the "Amazon Music" icon to display the login screen of Amazon Music. (Depending on the model, the icon names may be different.)
  - If the login screen is not displayed but an update or installation screen is displayed instead, perform the update or installation according to the on-screen instructions.

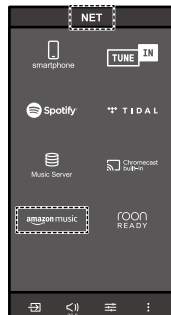

Available services may differ depending on your area.

4. Enter the Amazon account information such as email address and password to log in to Amazon. When the login is successful and this unit is registered, the Amazon Music menu is displayed. For playback, proceed to step 3 in the next section.

## Playing Amazon Music using the Onkyo Controller

1. Start up Onkyo Controller. This unit is automatically displayed after startup. Then, tap and select this unit displayed.
2. Operate Onkyo Controller, and switch to the NET selector. Then tap the "Amazon Music" icon.
3. Select the content to play from the menu screen of Amazon Music to start playback.



TIDAL



Use your phone, tablet or computer as a remote control for TIDAL.  
Go to <https://tidal.com/> to learn how.



## TuneIn



By connecting this unit to an Internet-connected network, you can enjoy Internet radio services such as TuneIn Radio.

- Use Onkyo Controller ( →[p37](#)) to play the Internet radio.
- Depending on the Internet radio service, a user registration may be required on your PC beforehand. For details of each service, visit the website of each service.

## Playing Back

---

1. Start up Onkyo Controller.
2. Select "NET" - "Tune In" from the input source.

### TuneIn Radio account

When you create an account on the website of TuneIn Radio ([tunein.com](http://tunein.com)) and log into the website from this unit, your favorite radio stations or programs you follow on the website are automatically added to "My Presets" on this unit. "My Presets" is displayed on the top list of TuneIn Radio. To log into the website, select "Login" - "I have a TuneIn account" on the top list of "TuneIn Radio" displayed on Onkyo Controller, and enter the user name and password.

- Selecting "Login" displays a registration code. Using this registration code, associate the device on my page on the TuneIn Radio website. Then, selecting "Login" - "Login with a registration code" allows you to log in without entering the user name and password.



## Music Server

### Music Server

Using Onkyo Controller ( →p37) enables streaming playback of music files stored on a PC or NAS.

- To play music files, this unit needs to be connected to the same network as that for the PC or NAS.
- Supported Audio Formats ( →p50)

## Music Server notes

- The network servers this unit is compatible with are those PCs with players installed that have the server functionality of Windows Media® Player 12, or NAS that are compatible with home network functionality. When using Windows Media® Player 12, you need to make the settings beforehand. Note that with PCs, only music files registered in the library of Windows Media® Player can be played.
- When playing files recorded with VBR (Variable bit-rate), the playback time may not be displayed correctly.
- For music files on a server, up to 20,000 tracks per folder are supported, and folders can be nested up to 16 levels deep.
- Depending on the type of media server, the unit may not recognize it, or may not be able to play its music files.

## Windows Media® Player 12 settings

1. Turn on your PC, and start Windows Media® Player 12.
2. In the "Stream" menu, select "Turn on media streaming" to display a dialog box.
  - If the media streaming is already turned on, select "More streaming options..." in the "Stream" menu to display the list of playback devices in the network, and then go to step 4.
3. Click "Turn on media streaming" to display the list of playback devices in the network.
4. Select this unit in "Media streaming options" and check that it is set to "Allow".
5. Click "OK" to close the dialog.
6. Open the "Stream" menu and confirm that "Allow remote control of my Player..." is checked.
  - Depending on the version of Windows Media® Player, the names of items to select may differ from the above description.

## Playing Back

1. Start up Onkyo Controller, and select "NET" - " Music Server" from the input source.
  - Selecting Music Server displays a PC or NAS in the same network as that for this unit.
2. Select the PC or NAS to play the music stored.
  - Depending on the type of media server, the unit may not recognize it, or may not be able to play its music files.



|   |    |
|---|----|
| Setup Flow  | 36 |
| Onkyo Controller  | 37 |
| Network settings  | 38 |
| Level Calibration   | 39 |
| Measuring with Dirac Live                                 | 40 |
| Using Dirac Live  | 41 |
| Firmware Update   | 42 |
| Settings Affecting Power Consumption<br>and Standby Power | 43 |
| Web Setup   | 44 |



# Setup

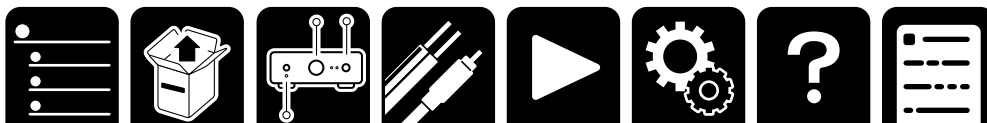

# Setup Flow

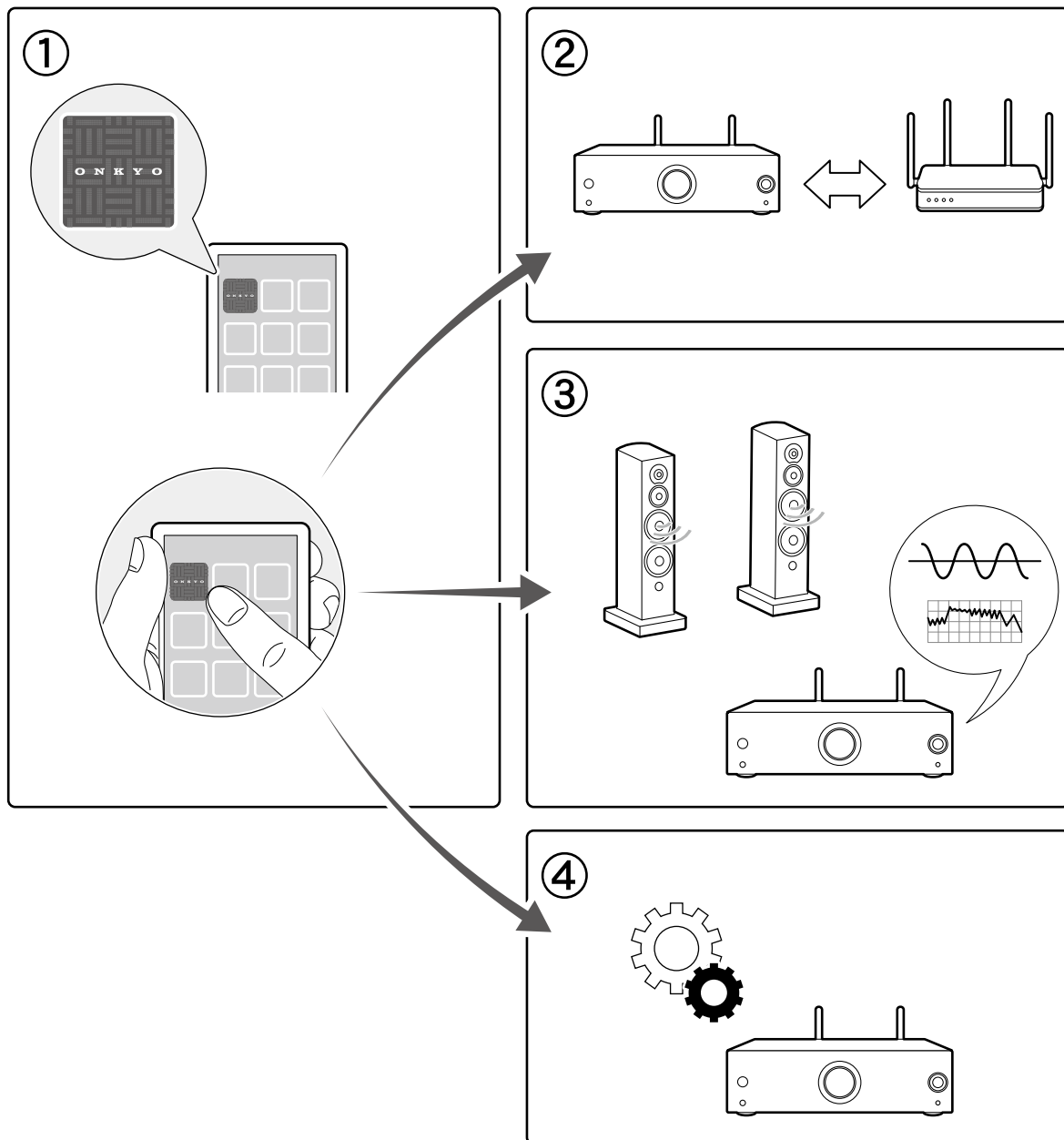

- ① Downloading Onkyo Controller ( →[p37](#) )
- ② Network settings ( →[p38](#) )
- ③ Level Calibration ( →[p39](#) )  
Measuring with Dirac Live ( →[p40](#) )
- ④ Firmware Update ( →[p42](#) )



# Onkyo Controller

Onkyo Controller (available on iOS and Android™ handsets) is a dedicated app available for free which allows you to use your handset as a remote controller. Using this app allows you to configure Wi-Fi (wireless LAN) settings for this unit, and perform input switching, volume adjustment, sound adjustment, etc.

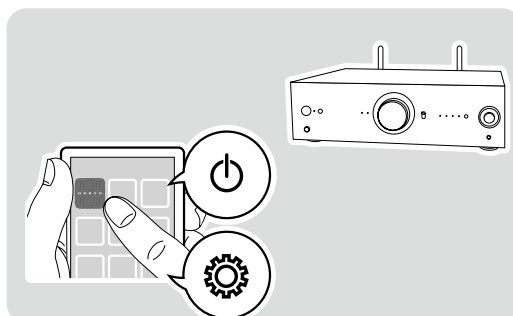

1. Download Onkyo Controller.



<https://onkyo.com/onkyo-app-ios>



<https://onkyo.com/onkyo-app-android>



# Network settings

## Preparation

- First, search for the main unit using the Bluetooth function. Turn on the Bluetooth function of the mobile device.
- The screen of the app and operation procedure may change depending on the version.

1. Turn on the power of the main unit, and wait for approx. 10 seconds until the system starts up completely.
2. Start up Onkyo Controller.
3. Tap "Device Management".
4. Tap the search icon (a) to start searching.  
When the main unit is found, tap and select it.
5. Enter the password of the wireless LAN router, and tap "Next".
6. After successfully connecting to the wireless LAN router, "Google Cast" will appear. Tap "Accept" to complete the network setup.

Next, you will configure settings such as Google Home and Level Calibration ( → [p39](#)).

• **At the end of setup, the Privacy Policy (b) will be displayed. To use all services, you must agree to the Privacy Policy.**

• To switch between wireless LAN and wired LAN after the initial setup, configure the settings via "Web Setup" – "Network Setting" ( → [p44](#)).

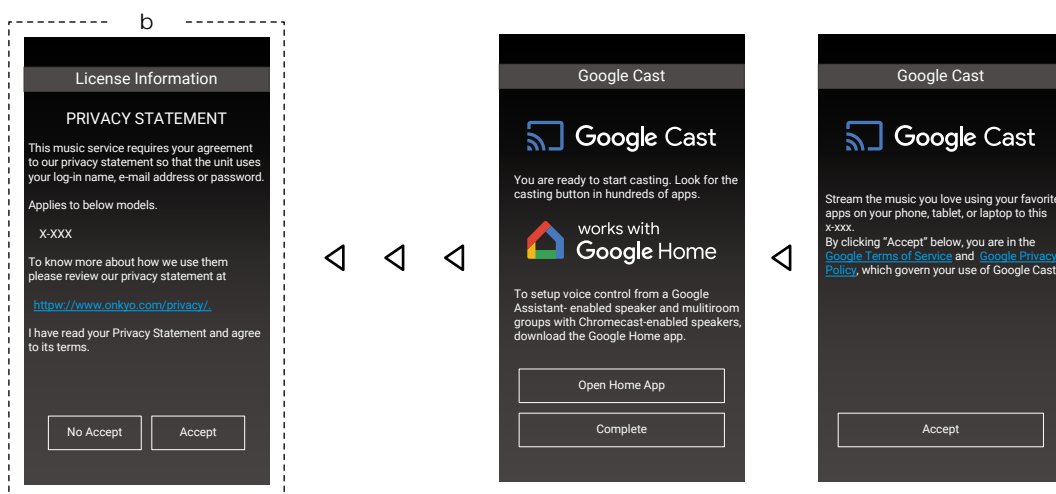
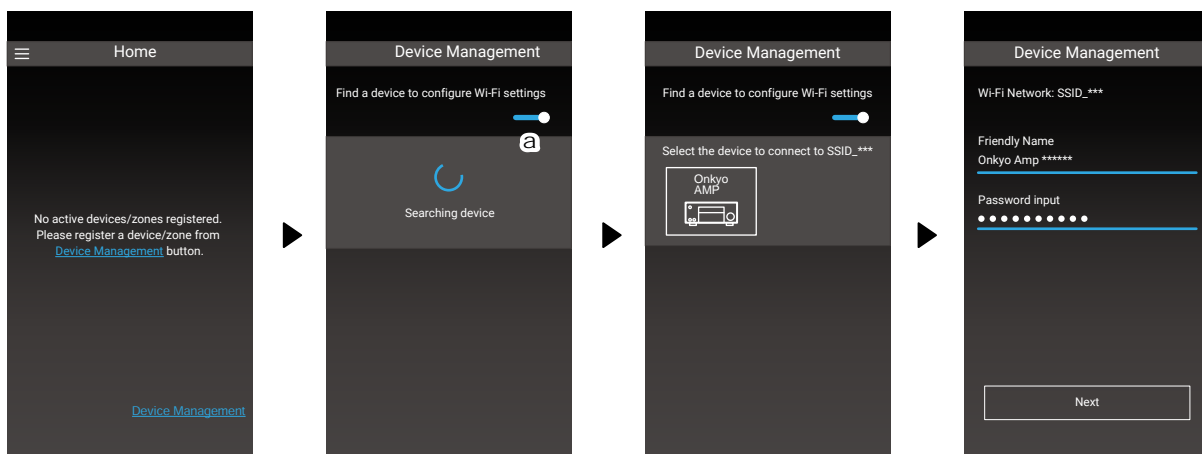

## Level Calibration

### Level Calibration for Fidelity IQ

Fidelity IQ is a technology to automatically correct hearing of sound volume for each frequency. A sense of hearing of a person differs in sensitivity depending on the frequency. For example, when vocal and bass are reproduced at the same input level, you will sense difference in sound volume. Fidelity IQ is activated without calibration (measurement) for quick use. Performing level calibration with the supplied speaker setup microphone measures the sound pressure level of the actual speaker, enabling correction the most suitable for the customer's environment.

1. Connect the speaker setup microphone (a) to the SETUP MIC jack of the main unit, and set up the microphone at the hearing position.  
After setup, tap "Calibration" to start measurement. When skipping this process, tap "Skip".

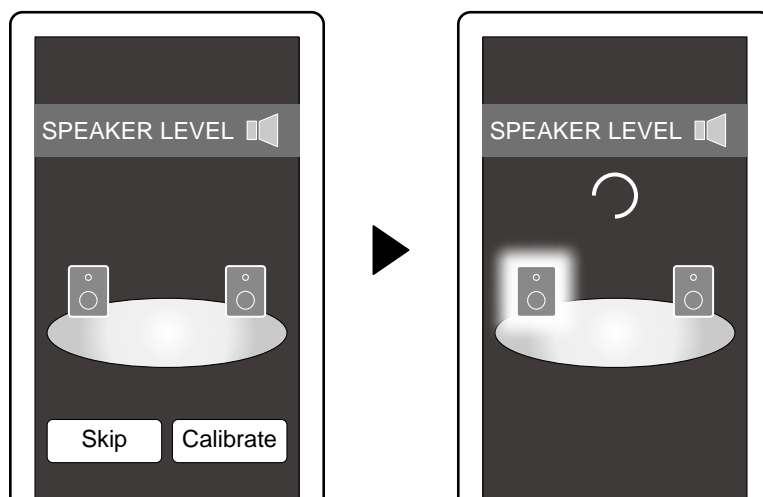
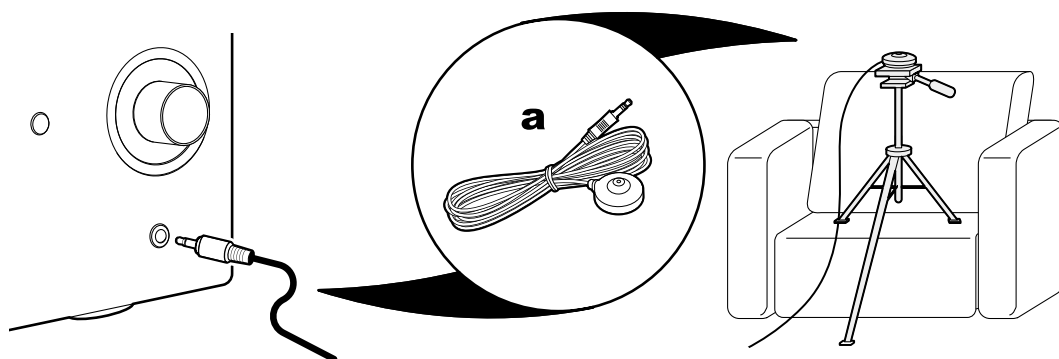

- Fidelity IQ can be used even if measurement is not performed. In this case, the hearing environment and speaker characteristics are not reflected.



# Measuring with Dirac Live



Dirac Live® is an advanced room correction technology developed by Dirac Research. As one of the most advanced room correction technology available on the market, Dirac Live helps listeners to correct for one of the weakest components in the audio chain: the listening room. Dirac Live not only corrects the frequency response, but also the impulse response of the loudspeakers in a room, yielding improved imaging and timbre, better clarity, tighter bass, and less early reflections, as well as reduced resonances and room modes.

## Additional Functions

### Dirac Live Bass Control

Dirac Live Bass Control is a technology to manage low-frequency channel routing from the signal to the playback channels (speakers) of your audio device. Additionally, with full control over the device's channel and frequency routing and output, the Dirac Live room correction technology is significantly augmented. In particular systems with multiple subwoofers will see a substantially improved room correction and bass performance.

To use Dirac Live Bass Control, you need to register with Dirac Live and obtain a Dirac Live Bass Control license. For more information, see the Dirac Live website.

1. Start the Onkyo Controller and tap the unit when displayed.  
\*The application for PCs allows for more detailed settings. ([Dirac Live for Onkyo](#))
2. Connect the supplied speaker setup microphone to the SETUP MIC jack on the main unit.

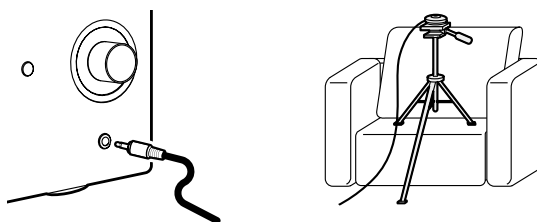

3. Follow the guidance of the app to start measurement.

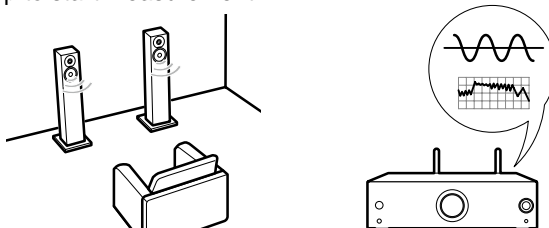

## Using Dirac Live

---

You can apply the filter curves adjusted based on the measurement results of Dirac Live. From the Onkyo Controller menu screen, select from "Slot1" to "Slot3". Select "Off" if you do not use Dirac Live.



# Firmware Update

**Disclaimer:** The program and accompanying online documentation are furnished to you for use at your own risk. Our company will not be liable and you will have no remedy for damages for any claim of any kind whatsoever concerning your use of the program or the accompanying online documentation, regardless of legal theory, and whether arising in tort or contract.

In no event will our company be liable to you or any third party for any special, indirect, incidental, or consequential damages of any kind, including, but not limited to, compensation, reimbursement or damages on account of the loss of present or prospective profits, loss of data, or for any other reason whatsoever.

## Note

- For the latest firmware contents and the firmware version, visit website.
- Do not turn off the power of the unit during update.
- **Some of the products forcibly start update when connected to the network.**  
**When all selector indicators are blinking, press the selector knob to start update.**  
**When the update is complete, the unit automatically enters the standby state.**

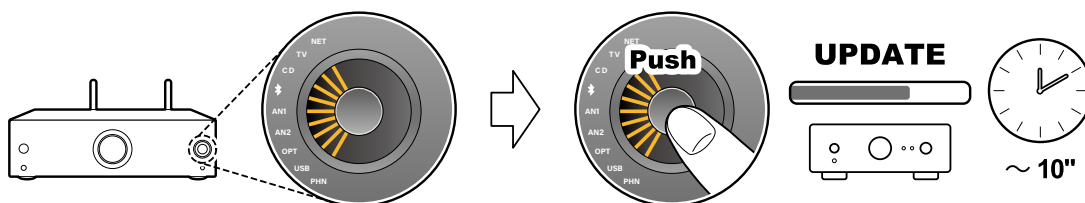

1. The firmware is updated via the network using Onkyo Controller ( →p37).  
 When the new firmware becomes available, a guidance is displayed on the screen of the app. Follow the on-screen instructions.
2. The update progress status can be checked on the selector indicators.  
 When the update is approaching the end, all MY INPUT indicators and selector indicators light up. Then after approx. three minutes elapse, the update is completed, and the unit automatically enters the standby state.

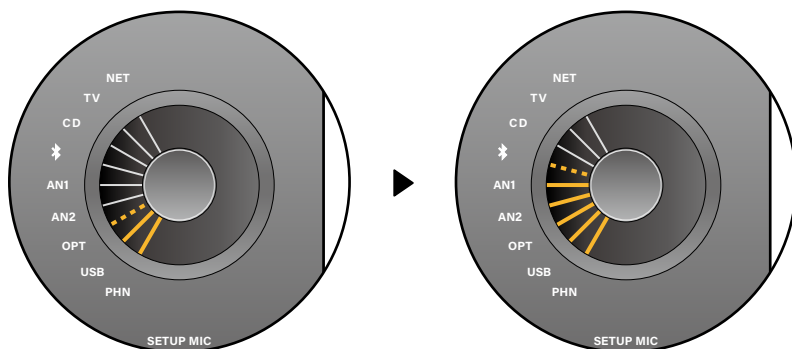

## Settings Affecting Power Consumption and Standby Power

When the following functions are enabled, the power consumption in standby state increases. To reduce the power consumption in standby state, check each setting and set the functions to "Off".

These settings are configured in Web Setup ( →[p44](#) ) .

**Network Standby** : When this function is set to "On", the network function works even in standby state, and you can turn on the power of the unit via network using an application such as Onkyo Controller that can control this unit.

**Bluetooth Wakeup** : This function wakes up the unit on standby by connecting a BLUETOOTH enabled device.

**HDMI CEC** : Setting this to "ON" enables the linkage function with an HDMI-connected TV to work, allowing for linkage of volume adjustment or power ON/OFF.

Setting the following function to "OFF" increases power consumption. To reduce the power consumption, confirm the setting and set this function to "ON".

**Auto Standby** : When no operation is performed on this unit for 20 minutes without audio input, this function automatically put the unit into the standby state. Setting this function to "OFF" increases the power consumption since the power-on state continues.



# Web Setup

## Menu operations

You can make the settings for the network function of this unit using an Internet browser on a PC, smartphone, etc.

1. Start Onkyo Controller ( →p37) and check the IP address of this unit displayed on the screen.
2. Start the Internet browser on your PC, smartphone, etc. and enter the IP address of this unit in the URL field.
3. The screen for entering the user name and password is displayed. Enter the following then click "OK".  
User name: admin (fixed)  
Password: admin (default value)
  - Input is required again if you close the browser.
4. Change the password.
  - Take a note of the password so that you do not forget it. If you do forget it, reset the unit ( →p45) then log in again with the initial settings (admin).
5. Information for the unit (Web Setup screen) is displayed in the internet browser.

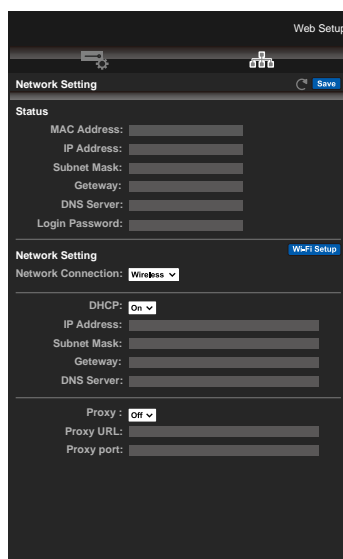
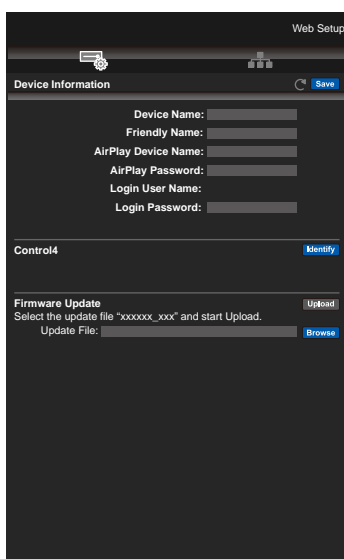

6. After changing the settings, select "Save" to save the settings.

### Device Information

You can change the Friendly Name or AirPlay Device Name, set an AirPlay Password, etc.

Control4: This device does not support this feature.

Firmware Update: Select the firmware file you have downloaded to your PC so you can update this unit.

### Network Setting

Status: You can see information for the network such as the MAC address and IP address of this unit.

Network Connection: You can select a network connection method. If you select "Wireless", select an access point from "Wi-Fi Setup" to connect.

DHCP: You can change DHCP settings. If you select "Off", set "IP Address", "Subnet Mask", "Gateway" and "DNS Server" manually.

Proxy: Display and set the URL for the proxy server.



# Troubleshooting

## ❑ When the unit is operating erratically

The problem may be remedied by restarting or initializing this unit.

### Restart procedure

The settings on this unit are retained.

1. Turn on the power of the unit, and wait for approx. 10 seconds.
2. Press and hold the ON/STANDBY button on the main unit for five seconds or more.

### Initialization procedure

All settings are restored to the default states at the time of purchase.

1. Turn on the power of the unit, and wait for approx. 10 seconds.
2. While pressing and holding the selector knob, press the ON/STANDBY button two times.
3. Press the selector knob once. At intervals of one to two seconds, press the knob again.

When the initialization is complete, the unit enters the standby state.

## ❑ All selector indicators are flashing.

Waiting for an update. Press the selector knob to start the update.

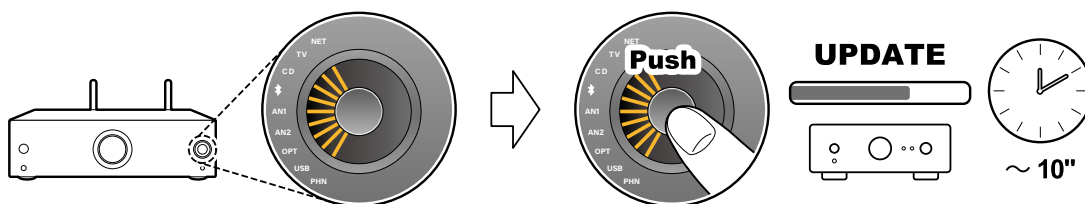

## ❑ Troubleshooting: The power does not turn on.

The protection circuit may be working.

Restart the unit and reconnect the cable according to the steps below.

1. Remove the AC cord from the unit, and wait for at least 10 minutes.
2. Connect the AC cord again.
3. Press the ON/STANDBY button to check if the power of the unit turns on.  
If the problem persists, a malfunction may have occurred.

## ❑ Troubleshooting: No sound is delivered from the right or left speaker.

When an external device is connected to this unit using an analog cable, a contact failure or disconnection of the cable may have occurred. Reconnect the cable or use another cable and check the condition.

When an external device is connected to this unit using a digital cable, check the audio output setting of the external device.

If there is no problem with the cable or the setting, a malfunction may have occurred in this unit.



## ❑ Troubleshooting: Pairing cannot be made with a BLUETOOTH-enabled device.

Remove the information from the BLUETOOTH-enabled device and perform pairing again according to the steps below.

1. Open the setting screen of the BLUETOOTH-enabled device (such as a smartphone and PC), and delete the information of this unit (device name) that has been registered.  
\*For details, refer to the instruction manual of the BLUETOOTH-enabled device.
2. Turn on the power of this unit, and turn the selector knob to switch the input source to **BLUETOOTH**.
3. Confirm that the BLUETOOTH indicator on the front panel blinks and the unit is in the pairing standby state.  
Then operate the BLUETOOTH-enabled device to perform pairing again.
4. When the pairing is successful and the BLUETOOTH indicator lights up, play music, etc. to check if the sound is output.



# General Specifications

## North America and Japan models

### ■ Amplifier Section

#### THD+N (Total Harmonic Distortion + Noise)

- 0.008% (20 Hz - 20,000 Hz, Half power)

#### Input Sensitivity and Impedance

- 200 mV/32 k $\Omega$  (LINE(RCA))
- 4 mV, 47 k $\Omega$ /0.4 mV, 110 $\Omega$  (PHONO MM/MC)

#### Rated RCA Output Level and Impedance

- 1 V/220  $\Omega$  (L/R PRE OUT)
- 1 V/470  $\Omega$  (SUBWOOFER PRE OUT)

#### Rated XLR Output Level and Impedance

- 2 V/220  $\Omega$  (L/R PRE OUT)

#### Phono Maximum Input Signal Voltage

- 70 mV (MM 1 kHz 0.5%)
- 7 mV (MC 1 kHz 0.5%)

#### Frequency Response

- 10 Hz - 100 kHz/+1 dB, -3 dB (Direct)

#### Tone Control Characteristics

- $\pm 10$  dB, 20 Hz (Bass),  $\pm 10$  dB, 20 kHz (Treble)

#### Headphone Rated Output

- 80 mW + 80 mW (32  $\Omega$ , 1 kHz, 10% THD)

#### Supported impedance of Headphones

- 8  $\Omega$  - 600  $\Omega$

#### Headphones Frequency Response

- 10 Hz - 100 kHz

#### Input terminals

##### Analog

- 4 (Including PHONO $\times 1$ )

##### Digital

- 2 (COAXIAL $\times 1$ , OPTICAL $\times 1$ )

\*Supported sampling rates for PCM signals (stereo, mono) from a digital input are 32 kHz, 44.1 kHz, 48 kHz, 88.2 kHz, 96 kHz/16 bit, 20 bit, and 24 bit.

#### Output terminal

##### Analog

- 3 (PRE OUT (RCA) $\times 1$ ,  
PRE OUT (SUBWOOFER 1/2) $\times 1$ ,  
PRE OUT (XLR) $\times 1$ , )

- PHONES jack

##### Digital

- 1 (OPTICAL $\times 1$ )

\*Audio of "NET", "USB", and "Bluetooth" can be output from the digital optical output terminal. Note that DSD is not supported.

- 1 (HDMI (ARC))

#### Other terminals

- Speaker terminal
- 12V TRIGGER OUT
- GND terminal

### ■ General

#### Power Supply

- AC 120 V, 60 Hz (North America model)
- AC 100V, 50/60 Hz (Japan model)

#### Power Consumption

- 35 W (North America model)
- 25 W (Japan model)

#### Network Standby (wired)

- 1.7 W (North America model)
- 1.6 W (Japan model)

#### Network Standby (wireless)

- 1.6 W (North America model)
- 1.6 W (Japan model)

#### Bluetooth Wakeup

- 1.8 W (North America model)
- 1.7 W (Japan model)

#### HDMI CEC Standby

- 0.1 W (North America model)
- 0.1 W (Japan model)

- Standby mode (ALL ON)

- 1.7 W (North America model)
- 1.7 W (Japan model)

#### Dimensions (W $\times$ H $\times$ D)

- 435 mm  $\times$  135 mm  $\times$  355 mm
- 17-1/8"  $\times$  5-5/16"  $\times$  14"

#### Weight

- 9.5 kg (20.9 lbs.)



## Europe models

### ■ Amplifier Section

#### THD+N (Total Harmonic Distortion + Noise)

- 0.008% (20 Hz - 20,000 Hz, Half power)

#### Input Sensitivity and Impedance

- 200 mV/32 k $\Omega$  (LINE(RCA))
- 4 mV, 47 k $\Omega$ /0.4 mV, 110 $\Omega$  (PHONO MM/MC)

#### Rated RCA Output Level and Impedance

- 1 V/220  $\Omega$  (L/R PRE OUT)
- 1 V/470  $\Omega$  (SUBWOOFER PRE OUT)

#### Rated XLR Output Level and Impedance

- 2 V/220  $\Omega$  (L/R PRE OUT)

#### Phono Maximum Input Signal Voltage

- 70 mV (MM 1 kHz 0.5%)
- 7 mV (MC 1 kHz 0.5%)

#### Frequency Response

- 10 Hz - 100 kHz/+1 dB, -3 dB (Direct)

#### Tone Control Characteristics

- $\pm 10$  dB, 20 Hz (Bass),  $\pm 10$  dB, 20 kHz (Treble)

#### Headphone Rated Output

- 80 mW + 80 mW (32  $\Omega$ , 1 kHz, 10% THD)

#### Supported impedance of Headphones

- 8  $\Omega$  - 600  $\Omega$

#### Headphones Frequency Response

- 10 Hz - 100 kHz

#### Input terminals

##### Analog

- 4 (Including PHONO $\times 1$ )

##### Digital

- 2 (COAXIAL $\times 1$ , OPTICAL $\times 1$ )

\*Supported sampling rates for PCM signals (stereo, mono) from a digital input are 32 kHz, 44.1 kHz, 48 kHz, 88.2 kHz, 96 kHz/16 bit, 20 bit, and 24 bit.

#### Output terminal

##### Analog

- 3 (PRE OUT (RCA) $\times 1$ , PRE OUT (SUBWOOFER 1/2) $\times 1$ , PRE OUT (XLR) $\times 1$ , )
- PHONES jack

##### Digital

- 1 (OPTICAL $\times 1$ )
- \*Audio of "NET", "USB", and "Bluetooth" can be output from the digital optical output terminal. Note that DSD is not supported.
- 1 (HDMI (ARC))

#### Other terminals

- Speaker terminal
- 12V TRIGGER OUT
- GND terminal

### ■ General

- Power Supply  
AC 220-240 V, 50/60 Hz
- Power Consumption  
35 W
- Network Standby (wired)  
1.8 W
- Network Standby (wireless)  
1.7 W
- Bluetooth Wakeup  
1.8 W
- HDMI CEC Standby  
0.2 W
- Standby mode (ALL ON)  
1.9 W
- Dimensions (W  $\times$  H  $\times$  D)  
435 mm  $\times$  135 mm  $\times$  355 mm  
17-1/8"  $\times$  5-5/16"  $\times$  14"
- Weight  
9.5 kg (20.9 lbs.)

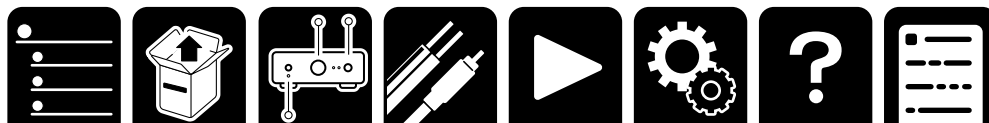

## Asia and Oceania models

### ■ Amplifier Section

#### THD+N (Total Harmonic Distortion + Noise)

- 0.008% (20 Hz - 20,000 Hz, Half power)

#### Input Sensitivity and Impedance

- 200 mV/32 k $\Omega$  (LINE(RCA))
- 4 mV, 47 k $\Omega$ /0.4 mV, 110 $\Omega$  (PHONO MM/MC)

#### Rated RCA Output Level and Impedance

- 1 V/220  $\Omega$  (L/R PRE OUT)
- 1 V/470  $\Omega$  (SUBWOOFER PRE OUT)

#### Rated XLR Output Level and Impedance

- 2 V/220  $\Omega$  (L/R PRE OUT)

#### Phono Maximum Input Signal Voltage

- 70 mV (MM 1 kHz 0.5%)
- 7 mV (MC 1 kHz 0.5%)

#### Frequency Response

- 10 Hz - 100 kHz/+1 dB, -3 dB (Direct)

#### Tone Control Characteristics

- $\pm 10$  dB, 20 Hz (Bass),  $\pm 10$  dB, 20 kHz (Treble)

#### Headphone Rated Output

- 80 mW + 80 mW (32  $\Omega$ , 1 kHz, 10% THD)

#### Supported impedance of Headphones

- 8  $\Omega$  - 600  $\Omega$

#### Headphones Frequency Response

- 10 Hz - 100 kHz

#### Input terminals

##### Analog

- 4 (Including PHONO $\times 1$ )

##### Digital

- 2 (COAXIAL $\times 1$ , OPTICAL $\times 1$ )

\*Supported sampling rates for PCM signals (stereo, mono) from a digital input are 32 kHz, 44.1 kHz, 48 kHz, 88.2 kHz, 96 kHz/16 bit, 20 bit, and 24 bit.

#### Output terminal

##### Analog

- 3 (PRE OUT (RCA) $\times 1$ , PRE OUT (SUBWOOFER 1/2) $\times 1$ , PRE OUT (XLR) $\times 1$ , )
- PHONES jack

##### Digital

- 1 (OPTICAL $\times 1$ )

\*Audio of "NET", "USB", and "Bluetooth" can be output from the digital optical output terminal. Note that DSD is not supported.

- 1 (HDMI (ARC))

#### Other terminals

- Speaker terminal
- 12V TRIGGER OUT
- GND terminal

### ■ General

- Power Supply  
AC 220-240 V, 50/60 Hz
- Power Consumption  
35 W
- Network Standby (wired)  
1.8 W
- Network Standby (wireless)  
1.7 W
- Bluetooth Wakeup  
1.8 W
- HDMI CEC Standby  
0.2 W
- Standby mode (ALL ON)  
1.9 W
- Dimensions (W  $\times$  H  $\times$  D)  
435 mm  $\times$  135 mm  $\times$  355 mm  
17-1/8"  $\times$  5-5/16"  $\times$  14"
- Weight  
9.5 kg (20.9 lbs.)

### WLAN Module

Model: AW-CM276NF

Brand: AzureWave

NCC ID: CCAI17LP040AT4

Operation Frequency:

WLAN

2412-2462

5180-5240

5260-5320

5500-5700

5745-5825

BT

2402-2480



## Common to all destinations

### ■ Network Section

#### Ethernet LAN

- 1 (10BASE-T/100BASE-TX)

#### Wireless LAN

- IEEE 802.11 a/b/g/n/ac standard (Wi-Fi® standard) 5 GHz/2.4 GHz band

### ■ BLUETOOTH Section

#### Communication system

- BLUETOOTH Specification version 5.1

#### Frequency band

- 2.4GHz (2.402-2.480GHz)

#### Modulation method

- FHSS (Frequency Hopping Spread Spectrum)

#### Compatible BLUETOOTH profiles

- A2DP 1.4, AVCTP 1.4, AVDTP 1.3, AVRCP 1.6.2

#### Supported Codecs

- Receiving: SBC, AAC
- Transmitting: SBC, aptX, aptX HD

#### Transmission range (A2DP)

- 20 Hz - 20 kHz (Sampling frequency 44.1kHz)

#### Maximum communication range

- Line of sight approx. 15 m(\*)
- (\*)The actual range will vary depending on factors such as obstacles between devices, magnetic fields around a microwave oven, static electricity, cordless phone, reception sensitivity, antenna's performance, operating system, software application, etc.

#### Maximum radio-frequency power transmitted in the frequency band(s)

- 2400 MHz - 2483.5 MHz (20 dBm (e.i.r.p))
- 5150 MHz - 5350 MHz (23 dBm (e.i.r.p))
- 5470 MHz - 5725 MHz (23 dBm (e.i.r.p))

### ■ Music Server (→p34)

#### Supported Audio Formats

##### MP3 (.mp3)

- MPEG-1/MPEG-2 Audio Layer-3/44.1 kHz, 48 kHz/ Between 8 and 320 kbps, and VBR/2 ch

##### WMA (.wma)

- 44.1 kHz, 48 kHz/Between 5 and 320 kbps, and VBR/2 ch

##### WAV (.wav)

WAV files contain uncompressed PCM digital audio.

- 44.1 kHz, 48 kHz, 88.2 kHz, 96 kHz, 176.4 kHz, 192 kHz/8 bit, 16 bit, 24 bit/2 ch

##### AIFF (.aiff/.aif)

AIFF files contain uncompressed PCM digital audio.

- 44.1 kHz, 48 kHz, 88.2 kHz, 96 kHz, 176.4 kHz, 192 kHz/8 bit, 16 bit, 24 bit/2 ch

##### AAC (.aac/.m4a/.mp4/.3gp/.3g2)

- MPEG-2/MPEG-4 Audio/44.1 kHz, 48 kHz, 88.2 kHz, 96 kHz/Between 8 and 320 kbps, and VBR/2 ch

##### FLAC (.flac)

- 44.1 kHz, 48 kHz, 88.2 kHz, 96 kHz, 176.4 kHz, 192 kHz/8 bit, 16 bit, 24 bit/2 ch

##### LPCM (Linear PCM)

- 44.1 kHz, 48 kHz/16 bit/2 ch

##### Apple Lossless (.m4a/.mp4)

- 44.1 kHz, 48 kHz, 88.2 kHz, 96 kHz, 176.4 kHz, 192 kHz/16 bit, 24 bit/2 ch

##### DSD (.dsf/.dff)

- DSF/DSDIFF/2.8 MHz, 5.6 MHz, 11.2 MHz/2 ch

### ■ USB Storage Device (→p27)

#### Supported Audio Formats

##### MP3 (.mp3)

- MPEG-1/MPEG-2 Audio Layer-3/44.1 kHz, 48 kHz/ Between 8 and 320 kbps, and VBR/2 ch

##### WMA (.wma)

- 44.1 kHz, 48 kHz/Between 5 and 320 kbps, and VBR/2 ch

##### WAV (.wav)

WAV files contain uncompressed PCM digital audio.

- 44.1 kHz, 48 kHz, 88.2 kHz, 96 kHz, 176.4 kHz, 192 kHz/8 bit, 16 bit, 24 bit/2 ch

##### AIFF (.aiff/.aif)

AIFF files contain uncompressed PCM digital audio.

- 44.1 kHz, 48 kHz, 88.2 kHz, 96 kHz, 176.4 kHz, 192 kHz/8 bit, 16 bit, 24 bit/2 ch

##### AAC (.aac/.m4a/.mp4/.3gp/.3g2)

- MPEG-2/MPEG-4 Audio/44.1 kHz, 48 kHz, 88.2 kHz, 96 kHz/Between 8 and 320 kbps, and VBR/2 ch

##### FLAC (.flac)

- 44.1 kHz, 48 kHz, 88.2 kHz, 96 kHz, 176.4 kHz, 192 kHz/8 bit, 16 bit, 24 bit/2 ch

##### Apple Lossless (.m4a/.mp4)

- 44.1 kHz, 48 kHz, 88.2 kHz, 96 kHz, 176.4 kHz, 192 kHz/16 bit, 24 bit/2 ch

##### DSD (.dsf/.dff)

- DSF/DSDIFF/2.8 MHz, 5.6 MHz, 11.2 MHz/2 ch



## License and Trademark

# HDMI



The terms HDMI and HDMI High-Definition Multimedia Interface, and the HDMI Logo are trademarks or registered trademarks of HDMI Licensing Administrator, Inc. in the United States and other countries.



The Wi-Fi CERTIFIED™ Logo is a certification mark of Wi-Fi Alliance®.



The BLUETOOTH® word mark and logos are registered trademarks owned by Bluetooth SIG, Inc.



Amazon, Amazon Music, and all related logos and motion marks are trademarks of Amazon.com, Inc. or its affiliates.



Use your phone, tablet or computer as a remote control for Spotify.

Go to [spotify.com/connect](https://www.spotify.com/connect) to learn how.

The Spotify software is subject to third party licenses found here:

<https://www.spotify.com/connect/third-party-licenses>

Apple, AirPlay®, iPad®, iPad Air®, iPad Pro®, iPhone®, iPod touch® and Lightning are trademarks of Apple Inc., registered in the U.S. and other countries.

Use of the Made for Apple badge means that an accessory has been designed to connect specifically to the Apple product(s) identified in the badge, and has been certified by the developer to meet Apple performance standards. Apple is not responsible for the operation of this device or its compliance with safety and regulatory standards. Please note that the use of this accessory with an Apple product may affect wireless performance.

Apple, AirPlay, iPad, iPad Air, iPad Pro, iPhone, iPod touch and Lightning are trademarks of Apple Inc., registered in the U.S. and other countries.

Use of the Works with Apple badge means that an accessory has been designed to work specifically with the technology identified in the badge and has been certified by the developer to meet Apple performance standards.

Apple, AirPlay, iPad, iPad Air, iPad Pro, iPhone, iPod touch et Lightning sont des marques commerciales d'Apple Inc., enregistrées aux États-Unis et dans d'autres pays.

L'utilisation du badge Made for Apple signifie qu'un accessoire a été conçu pour se connecter spécifiquement aux produits Apple identifiés dans le badge, et qu'il a été certifié par le développeur comme répondant aux normes de performances d'Apple. Apple n'est pas responsable du fonctionnement de cet appareil ou sa conformité aux normes réglementaires et de sécurité. Veuillez noter que l'utilisation de cet accessoire avec un produit Apple peut affecter les performances de la connexion sans fil.

Apple, AirPlay, iPad, iPad Air, iPad Pro, iPhone, iPod touch et Lightning sont des marques commerciales d'Apple Inc., enregistrées aux États-Unis et dans d'autres pays.

L'utilisation du badge Works with Apple signifie qu'un accessoire a été conçu pour fonctionner spécifiquement avec la technologie identifiée dans le badge et qu'il a été certifié par le développeur comme répondant aux normes de performances d'Apple.

App Store is a service mark of Apple Inc., registered in the U.S. and other countries.

IOS is a trademark or registered trademark of Cisco in the U.S. and other countries and is used under license.



**O N K Y O**

SN 29404225D\_EN

© Copyright 2025 Premium Audio Company Technology Center K.K. All rights reserved.

© Copyright 2025 Premium Audio Company Technology Center K.K. Tous droits de reproduction et de traduction réservés.

Privacy Policy, available at [<https://onkyo.com/intl/privacy-policy>].

O2603-4