

ONKYO®

DVD PLAYER

DV-SP406

Instruction Manual

Thank you for purchasing an Onkyo DVD Player. Please read this manual thoroughly before making connections and plugging in the unit. Following the instructions in this manual will enable you to obtain optimum performance and listening enjoyment from your new DVD Player. Please retain this manual for future reference.

Contents

Overview 2

Connections and Setting up 15

Playback Operation..... 24

Miscellaneous Information..... 33



WARNING:

TO REDUCE THE RISK OF FIRE OR ELECTRIC SHOCK, DO NOT EXPOSE THIS APPARATUS TO RAIN OR MOISTURE.

CAUTION:

TO REDUCE THE RISK OF ELECTRIC SHOCK, DO NOT REMOVE COVER (OR BACK). NO USER-SERVICEABLE PARTS INSIDE. REFER SERVICING TO QUALIFIED SERVICE PERSONNEL.



WARNING
RISK OF ELECTRIC SHOCK
DO NOT OPEN

AVIS
RISQUE DE CHOC ELECTRIQUE
NE PAS OUVRIR



The lightning flash with arrowhead symbol, within an equilateral triangle, is intended to alert the user to the presence of uninsulated “dangerous voltage” within the product’s enclosure that may be of sufficient magnitude to constitute a risk of electric shock to persons.



The exclamation point within an equilateral triangle is intended to alert the user to the presence of important operating and maintenance (servicing) instructions in the literature accompanying the appliance.

Important Safety Instructions

1. Read these instructions.
2. Keep these instructions.
3. Heed all warnings.
4. Follow all instructions.
5. Do not use this apparatus near water.
6. Clean only with dry cloth.
7. Do not block any ventilation openings. Install in accordance with the manufacturer’s instructions.
8. Do not install near any heat sources such as radiators, heat registers, stoves, or other apparatus (including amplifiers) that produce heat.
9. Do not defeat the safety purpose of the polarized or grounding-type plug. A polarized plug has two blades with one wider than the other. A grounding type plug has two blades and a third grounding prong. The wide blade or the third prong are provided for your safety. If the provided plug does not fit into your outlet, consult an electrician for replacement of the obsolete outlet.
10. Protect the power cord from being walked on or pinched particularly at plugs, convenience receptacles, and the point where they exit from the apparatus.
11. Only use attachments/accessories specified by the manufacturer.
12. Use only with the cart, stand, tripod, bracket, or table specified by the manufacturer, or sold with the apparatus. When a cart is used, use caution when moving the cart/apparatus combination to avoid injury from tip-over.

PORTABLE CART WARNING
S3125A
13. Unplug this apparatus during lightning storms or when unused for long periods of time.
14. Refer all servicing to qualified service personnel. Servicing is required when the apparatus has been damaged in any way, such as power-supply cord or plug is damaged, liquid has been spilled or objects have fallen into the apparatus, the apparatus has been exposed to rain or moisture, does not operate normally, or has been dropped.
15. Damage Requiring Service
Unplug the apparatus from the wall outlet and refer servicing to qualified service personnel under the following conditions:
 - A. When the power-supply cord or plug is damaged,
 - B. If liquid has been spilled, or objects have fallen into the apparatus,
 - C. If the apparatus has been exposed to rain or water,
 - D. If the apparatus does not operate normally by following the operating instructions. Adjust only those controls that are covered by the operating instructions as an improper adjustment of other controls may result in damage and will often require extensive work by a qualified technician to restore the apparatus to its normal operation,
 - E. If the apparatus has been dropped or damaged in any way, and
 - F. When the apparatus exhibits a distinct change in performance this indicates a need for service.
16. Object and Liquid Entry
Never push objects of any kind into the apparatus through openings as they may touch dangerous voltage points or short-out parts that could result in a fire or electric shock.
The apparatus shall not be exposed to dripping or splashing and no objects filled with liquids, such as vases shall be placed on the apparatus.
Don’t put candles or other burning objects on top of this unit.
17. Batteries
Always consider the environmental issues and follow local regulations when disposing of batteries.
18. If you install the apparatus in a built-in installation, such as a bookcase or rack, ensure that there is adequate ventilation.
Leave 20 cm (8") of free space at the top and sides and 10 cm (4") at the rear. The rear edge of the shelf or board above the apparatus shall be set 10 cm (4") away from the rear panel or wall, creating a flue-like gap for warm air to escape.

Precautions

1. **Recording Copyright**—Unless it's for personal use only, recording copyrighted material is illegal without the permission of the copyright holder.
2. **AC Fuse**—The AC fuse inside the unit is not user-serviceable. If you cannot turn on the unit, contact your Onkyo dealer.
3. **Care**—Occasionally you should dust the unit all over with a soft cloth. For stubborn stains, use a soft cloth dampened with a weak solution of mild detergent and water. Dry the unit immediately afterwards with a clean cloth. Don't use abrasive cloths, thinners, alcohol, or other chemical solvents, because they may damage the finish or remove the panel lettering.

4. Power

WARNING

BEFORE PLUGGING IN THE UNIT FOR THE FIRST TIME, READ THE FOLLOWING SECTION CAREFULLY.

AC outlet voltages vary from country to country. Make sure that the voltage in your area meets the voltage requirements printed on the unit's rear panel (e.g., AC 230 V, 50 Hz or AC 120 V, 60 Hz).

The power cord plug is used to disconnect this unit from the AC power source. Make sure that the plug is readily operable (easily accessible) at all times.

For American model

Pressing the [STANDBY/ON] button to select Standby mode does not fully shutdown the unit. If you do not intend to use the unit for an extended period, remove the power cord from the AC outlet.

5. **Never Touch this Unit with Wet Hands**—Never handle this unit or its power cord while your hands are wet or damp. If water or any other liquid gets inside this unit, have it checked by your Onkyo dealer.
6. **Handling Notes**
 - If you need to transport this unit, use the original packaging to pack it how it was when you originally bought it.
 - Do not leave rubber or plastic items on this unit for a long time, because they may leave marks on the case.
 - This unit's top and rear panels may get warm after prolonged use. This is normal.
 - If you do not use this unit for a long time, it may not work properly the next time you turn it on, so be sure to use it occasionally.
 - When you've finished using this unit, remove all discs and turn off the power.
7. **Installing this Unit**
 - Install this unit in a well-ventilated location.
 - Ensure that there's adequate ventilation all around this unit, especially if it's installed in an audio rack. If the ventilation is inadequate, the unit may overheat, leading to malfunction.

- Do not expose this unit to direct sunlight or heat sources, because its internal temperature may rise, shortening the life of the optical pickup.
- Avoid damp and dusty places, and places subject to vibrations from loudspeakers. Never put the unit on top of, or directly above a loudspeaker.
- Install this unit horizontally. Never use it on its side or on a sloping surface, because it may cause a malfunction.
- If you install this unit near a TV, radio, or VCR, the picture and sound quality may be affected. If this occurs, move this unit away from the TV, radio, or VCR.

8. **To Obtain a Clear Picture**—This unit is a high-tech, precision device. If the lens on the optical pickup, or the disc drive mechanism becomes dirty or worn, the picture quality may be affected. To maintain the best picture quality, we recommend regular inspection and maintenance (cleaning or worn part replacement) every 1,000 hours of use depending on the operating environment. Contact your Onkyo dealer for details.

9. Moisture Condensation



Moisture condensation may damage this unit.

Read the following carefully:

Moisture may condense on the lens of the optical pickup, one of the most important parts inside this unit.

- Moisture condensation can occur in the following situations:
 - The unit is moved from a cold place to a warm place.
 - A heater is turned on, or cold air from an air conditioner is hitting the unit.
 - In the summer, when this unit is moved from an air conditioned room to a hot and humid place.
 - The unit is used in a humid place.
- Do not use this unit when there's the possibility of moisture condensation occurring. Doing so may damage your discs and certain parts inside this unit.

If condensation does occur, remove all discs and leave this unit turned on for two to three hours. By this time, the unit will have warmed up and any condensation will have evaporated.

10. **Region Numbers**—The DVD standard uses region numbers to control how discs can be played around the world, the world being divided into six regions. This unit will only play DVD discs that match its region number, which can be found on its rear panel (e.g., , ).

11. **About this Manual**—This manual explains how to use all of this unit's functions. Although the DVD standard offers many special features, not all discs use them all, so depending on the disc being played, this unit may not respond to certain functions. See the disc's sleeve notes for supported features.

Precautions—Continued

This unit contains a semiconductor laser system and is classified as a “CLASS 1 LASER PRODUCT”. So, to use this model properly, read this Instruction Manual carefully. In case of any trouble, please contact the store where you purchased the unit.

To prevent being exposed to the laser beam, do not try to open the enclosure.

CAUTION:

CLASS 1M VISIBLE AND INVISIBLE LASER RADIATION WHEN OPEN. DO NOT VIEW DIRECTLY WITH OPTICAL INSTRUMENTS. THIS PRODUCT UTILIZES A LASER. USE OF CONTROLS OR ADJUSTMENTS OR PERFORMANCE OF PROCEDURES OTHER THAN THOSE SPECIFIED HEREIN MAY RESULT IN HAZARDOUS RADIATION EXPOSURE.

The label on the right is applied on the rear panel.



1. This unit is a CLASS 1 LASER PRODUCT and employs a laser inside the cabinet.
2. To prevent the laser from being exposed, do not remove the cover. Refer servicing to qualified personnel.

For U.S. models

FCC Information for User

CAUTION:

The user changes or modifications not expressly approved by the party responsible for compliance could void the user's authority to operate the equipment.

NOTE:

This equipment has been tested and found to comply with the limits for a Class B digital device, pursuant to Part 15 of the FCC Rules. These limits are designed to provide reasonable protection against harmful interference in a residential installation.

This equipment generates, uses and can radiate radio frequency energy and, if not installed and used in accordance with the instructions, may cause harmful interference to radio communications. However, there is no guarantee that interference will not occur in a particular installation. If this equipment does cause harmful interference to radio or television reception, which can be determined by turning the equipment off and on, the user is encouraged to try to correct the interference by one or more of the following measures:

- Reorient or relocate the receiving antenna.
- Increase the separation between the equipment and receiver.
- Connect the equipment into an outlet on a circuit different from that to which the receiver is connected.
- Consult the dealer or an experienced radio/TV technician for help.

For Canadian Models

NOTE: THIS CLASS B DIGITAL APPARATUS COMPLIES WITH CANADIAN ICES-003.

For models having a power cord with a polarized plug:

CAUTION: TO PREVENT ELECTRIC SHOCK, MATCH WIDE BLADE OF PLUG TO WIDE SLOT, FULLY INSERT.

Modèle pour les Canadien

REMARQUE: CET APPAREIL NUMÉRIQUE DE LA CLASSE B EST CONFORME À LA NORME NMB-003 DU CANADA.

Sur les modèles dont la fiche est polarisée:

ATTENTION: POUR ÉVITER LES CHOCS ÉLECTRIQUES, INTRODUIRE LA LAME LA PLUS LARGE DE LA FICHE DANS LA BORNE CORRESPONDANTE DE LA PRISE ET POUSSER JUSQU'AU FOND.

Precautions—Continued

For British models

Replacement and mounting of an AC plug on the power supply cord of this unit should be performed only by qualified service personnel.

IMPORTANT

The wires in the mains lead are coloured in accordance with the following code:

Blue: Neutral

Brown: Live

As the colours of the wires in the mains lead of this apparatus may not correspond with the coloured markings identifying the terminals in your plug, proceed as follows:

The wire which is coloured blue must be connected to the terminal which is marked with the letter N or coloured black.

The wire which is coloured brown must be connected to the terminal which is marked with the letter L or coloured red.

IMPORTANT

The plug is fitted with an appropriate fuse. If the fuse needs to be replaced, the replacement fuse must be approved by ASTA or BSI to BS1362 and have the same ampere rating as that indicated on the plug. Check for the ASTA mark or the BSI mark on the body of the fuse. If the power cord's plug is not suitable for your socket outlets, cut it off and fit a suitable plug. Fit a suitable fuse in the plug.

For European Models

Declaration of Conformity

We, ONKYO EUROPE
ELECTRONICS GmbH
LIEGNITZERSTRASSE 6,
82194 GROEBENZELL,
GERMANY



declare in own responsibility, that the ONKYO product described in this instruction manual is in compliance with the corresponding technical standards such as EN60065, EN55013, EN55020 and EN61000-3-2, -3-3.

GROEBENZELL, GERMANY

K. MIYAGI

ONKYO EUROPE ELECTRONICS GmbH

Supplied Accessories

Make sure you have the following accessories:

RC-725DV

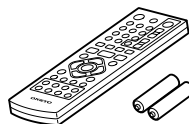

Remote controller & 2 batteries (AAA)

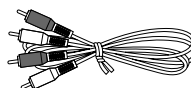

Audio cable (RCA)
(North American model: 1.8 m, Other model: 1.2 m)

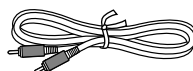

Video cable
(North American model: 1.8 m, Other model: 1.2 m)



Coaxial cable (1.2 m)

* In catalogs and on packaging, the letter at the end of the product name indicates the color. Specifications and operation are the same regardless of color.

Features

Audio / Video Processing

- Dolby^{*1} Digital and DTS^{*2} Digital Outputs
- 192 kHz/24-Bit Audio D/A Converter
- MP3 / WMA^{*3} Playback with Onscreen Display
- Progressive Scan Video Output
- 108 MHz/14-Bit Video D/A Converter

Connections

- HDMI^{*4} output with 1080p Upscaling
- Component Video, S-Video and Composite Video Outputs (North American & Oceanian models)
- Component Video, Composite Video Outputs (European model)
- 2 Digital Outputs (Optical / Coaxial)
- SCART Connector (European models only)
- USB Interface for Mass Storage Devices (Playable MP3, WMA, DivX^{*5}, and JPEG) (not North American model)

Miscellaneous

- DVD Video, VCD, DVD±R/RW*, MP3 CD, WMA CD, Audio CD, CD-R/RW, JPEG Encoded Picture CD Playback
 - * Discs that have not been properly finalized may only be partially playable or not playable at all
- DivX Video Playable
- Dynamic Range Control
- Marker Function-Search Function via Remote
- Last Play Memory
- Resume Function
- Random and Program Play (CD / MP3 / WMA)
- TITLE/CHAPTER/TRACK Repeat
- Step and Slow Motion Playback
- Picture Zoom Function
- Disc Navigator for Easy Browsing
- Onscreen Display
- Available in Black and Silver
- Compatible with Onkyo Receiver Remote Control Supplied (On/Standby, Input Up/Down, Volume Up/Down, Muting)

*1 Manufactured under license from Dolby Laboratories.
“Dolby” and the double-D symbol are trademarks of Dolby Laboratories.



*2 Manufactured under license under U.S. Patent #: 5,451,942 & other U.S. and worldwide patents issued & pending. DTS and DTS Digital Out are registered trademarks and the DTS logos and Symbol are trademarks of DTS, Inc. ©1996-2007 DTS, Inc. All Rights Reserved.



*3 Windows Media, and the Windows logo are trademarks, or registered trademarks of Microsoft Corporation in the United States and/or other countries.



*4 HDMI, the HDMI logo and High-Definition Multimedia Interface are trademarks or registered trademarks of HDMI licensing LLC.



*5 DivX, DivX Certified, and associated logos are trademarks of DivX, Inc. and are used under license.



Contents

Overview

Important Safety Instructions	2
Precautions	3
Supplied Accessories	5
Features	6
Types of Playable Discs	8
Before Using the DVD player	10
Installing the Batteries.....	10
Using the Remote Controller.....	10
Front & Rear Panels	11
Front Panel	11
Rear Panel	12
Remote control	13

Miscellaneous Information

Language Codes	33
Area Codes	33
Glossary	34
Troubleshooting	36
Specifications	38

Connections and Setting up

Connecting the DVD player	15
Before Making Any Connections.....	15
AV Cables & Connectors	15
Audio and Video Connection	16
HDMI Connection.....	19
Connecting the Power/Turning on the DVD player	20
Setting the TV system (Not North American model)	20
Adjust the settings	21
Adjust the settings - more you can do.....	21
Displaying Disc Information	23
Displaying Disc Information - more you can do.....	23

Playback Operation

Playing a Disc	24
Playing a Disc - more you can do	24
Playing a DivX movie file	27
Playing a DivX movie file - more you can do.....	27
Listening to Music Disc or files	28
Listening to Music Disc or files - more you can do.....	28
Viewing photo files	30
Viewing photo files - more you can do	30
Using an USB Flash Drive (European & Other models only)	32

Types of Playable Discs

Type	Logo
DVD-VIDEO: Discs such as movies that can be purchased or rented.	
DVD-R: Video mode and finalized only	
DVD-RW: VR mode, Video mode and finalized only	
DVD+R: Video mode only	
DVD+RW: Video mode only	
Video CD (VCD): Video CDs or CD-R/CD-RW in Video CD format.	
Audio CD: Music CDs or CD-R/CD-RW in music CD format that can be purchased.	
This unit plays DVD±R/RW and CD-R/RW that contains audio titles, DivX, MP3, WMA and/or JPEG files. Some DVD±RW/DVD±R or CD-RW/CD-R cannot be played on this unit due to the recording quality or physical condition of the disc, or the characteristics of the recording device and authoring software.	

- The DVD player does not support DVD-VR discs that use CPRM (Content Protection for Recordable Media).
- Some audio CDs feature copy protection that doesn't conform to the official CD standard. Since these are nonstandard discs, they may not play properly in the DVD player.
- The DVD player does not support disc types not listed.
- The DVD player supports 8 cm and 12 cm discs.
- Don't use discs with an unusual shape, such as those shown below, because you may damage the DVD player.



- Don't use discs that have residue from adhesive tape, rental discs with peeling labels, or discs with custom-made labels or stickers. Doing so may damage the DVD player and you may not be able to remove the disc properly.

About playing copy-controlled CDs

Some copy-controlled CDs may not conform to official CD standards. They are special discs and may not play on the DVD player.

About the Symbol Display

“” may appear on your TV display during operation and indicates that the function explained in this Instruction Manual is not available on that disc.

Regional Codes

This unit has a regional code printed on the rear of the unit. This unit can play only DVD discs labeled same as the rear of the unit or “ALL”.

- Most DVD discs have a globe with one or more numbers in it clearly visible on the cover. This number must match your unit's regional code or the disc cannot play.
- If you try to play a DVD with a different regional code from your player, the message “Check Regional Code” appears on the TV screen.

DVD-Video regions

All DVD-Video discs carry a region mark on the case somewhere that indicates which region(s) of the world the disc is compatible with. Your DVD player also has a region mark, which you can find on the rear panel. Discs from incompatible regions will not play in this player. Discs marked “ALL” will play in any player.

The diagram below shows the various DVD regions of the world.

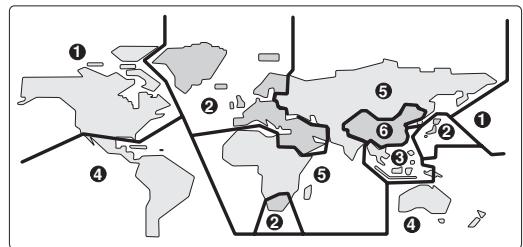

Types of Playable Discs—Continued

Handling Discs

- Never touch the underside of a disc. Always hold discs by the edge, as shown.

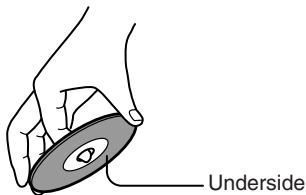

- Never attach adhesive tape or sticky labels to discs.



Cleaning Discs

- For best results, keep your discs clean. Fingerprints and dust can affect the sound and picture quality and should be removed as follows. Using a clean soft cloth, wipe from the center outwards, as shown. Never wipe in a circular direction.



- To remove stubborn dust or dirt, wipe the disc with a damp soft cloth, and then dry it with a dry cloth.
- Never use solvent-based cleaning fluids, such as thinner or benzine, commercially available cleaners, or antistatic sprays intended for vinyl records, because they may damage the disc.

Storing Discs

- Don't store discs in places subject to direct sunlight, or near heat sources.
- Don't store discs in places subject to moisture or dust, such as in a bathroom or near a humidifier.
- Always store discs in their cases and vertically. Stacking, or putting objects on unprotected discs may cause warping, scratches, or other damage.

Copyrights

It is forbidden by law to copy, broadcast, show, broadcast via cable, play in public, or rent copyrighted material without permission. This product features the copy protection function developed by Macrovision. Copy protection signals are recorded on some discs. When recording and playing the pictures of these discs picture noise will appear. This product incorporates copyright protection technology that is protected by method claims of certain U.S. patents and other intellectual property rights owned by Macrovision Corporation and other rights owners. Use of this copyright protection technology must be authorized by Macrovision Corporation, and is intended for home and other limited viewing uses only unless otherwise authorized by Macrovision Corporation. Reverse engineering or disassembly is prohibited.

CONSUMERS SHOULD NOTE THAT NOT ALL HIGH DEFINITION TELEVISION SETS ARE FULLY COMPATIBLE WITH THIS PRODUCT AND MAY CAUSE ARTIFACTS TO BE DISPLAYED IN THE PICTURE. IN CASE OF 525 PROGRESSIVE SCAN PICTURE PROBLEMS, IT IS RECOMMENDED THAT THE USER SWITCH THE CONNECTION TO THE 'STANDARD DEFINITION' OUTPUT. IF THERE ARE QUESTIONS REGARDING OUR TV SET COMPATIBILITY WITH THIS MODEL 525p UNIT, PLEASE CONTACT OUR CUSTOMER SERVICE CENTER.

Before Using the DVD player

Installing the Batteries

- 1 Open the battery compartment, as shown.

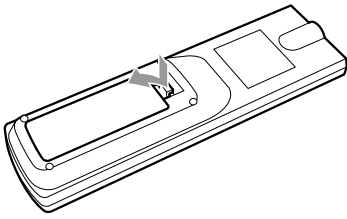

- 2 Insert the two supplied batteries (AAA/R03) in accordance with the polarity diagram inside the battery compartment.

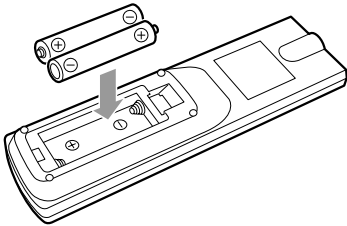

- 3 Close the battery compartment.

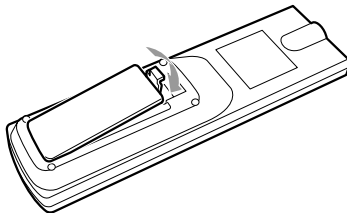

Notes:

- If the remote controller doesn't work reliably, try replacing both batteries.
- Don't mix new and old batteries, or different types of batteries.
- If you intend not to use the remote controller for a long time, remove the batteries to prevent possible leakage and corrosion.
- Flat batteries should be removed as soon as possible to prevent possible leakage and corrosion.

Using the Remote Controller

To use the remote controller, point it at the DVD player's remote control sensor, as shown below.

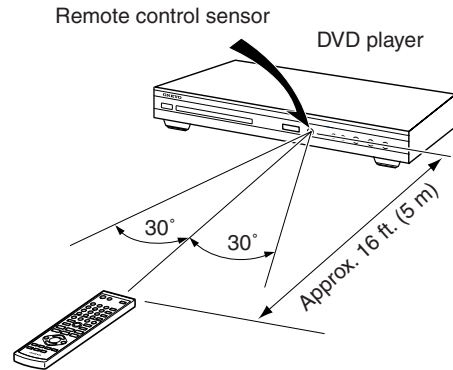

Notes:

- The remote controller may not work reliably if the DVD player is subjected to bright light, such as direct sunlight or inverter-type fluorescent lights. Keep this in mind when installing the DVD player.
- If another remote controller of the same type is used in the same room, or the DVD player is installed close to equipment that uses infrared rays, the remote controller may not work reliably.
- Don't put anything, such as a book, on the remote controller, because the buttons may be pressed inadvertently, thereby draining the batteries.
- The remote controller may not work reliably if the DVD player is installed in a rack behind colored glass doors. Keep this in mind when installing the DVD player.
- The remote controller will not work if there's an obstacle between it and the DVD player's remote control sensor.

Front & Rear Panels

Front Panel

For detailed information, refer to the pages in parentheses.

■ North American model

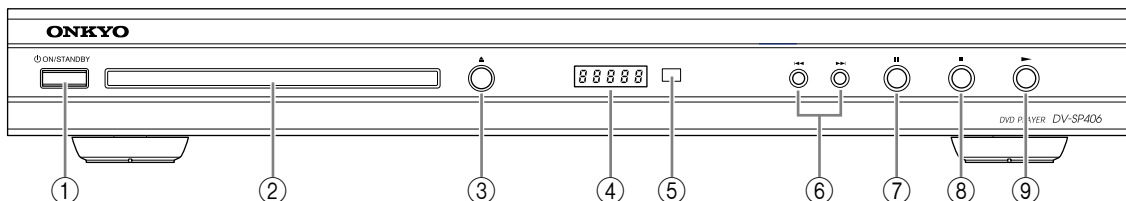

■ European & Other models

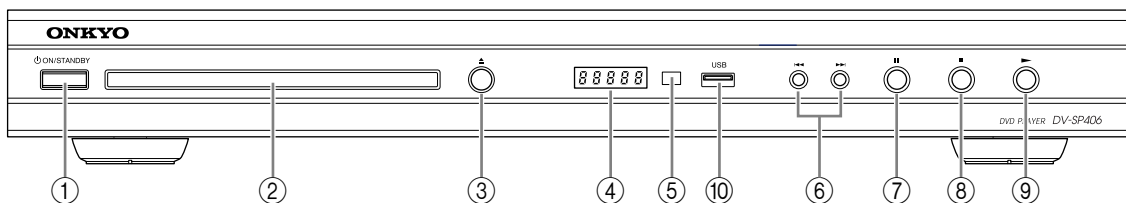

- ① **ON/STANDBY button (20)**
Sets the DVD player to On or Standby.
- ② **Disc Tray**
Discs are loaded here.
- ③ **[▲] (open/close) button (24)**
This button is used to open and close the disc tray.
- ④ **Display window**
Shows the current status of the DVD player.
- ⑤ **Remote sensor (10)**
This sensor receives control signals from the remote controller.
- ⑥ **Previous/Next [◀]/[▶] buttons (24, 30)**
Returns to the beginning of current chapter or track or go to the previous chapter or track.
Next button is used to select the next chapter or track.
- ⑦ **[||] (Pause) button (20, 24, 30)**
This button is used to pause playback.
- ⑧ **[■] (Stop) button (24)**
This button is used to stop playback.
- ⑨ **[▶] (Play) button (24)**
This button is used to start playback.
- ⑩ **USB Port (European and other models only) (32)**
Connect an USB Flash Drive.

Rear Panel

■ North American and Oceanian models

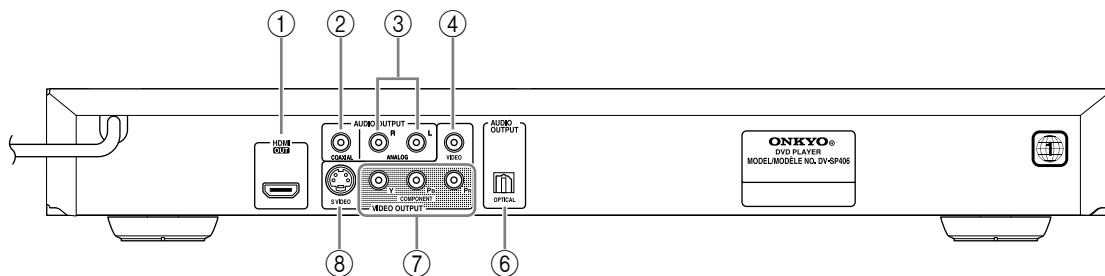

■ European model

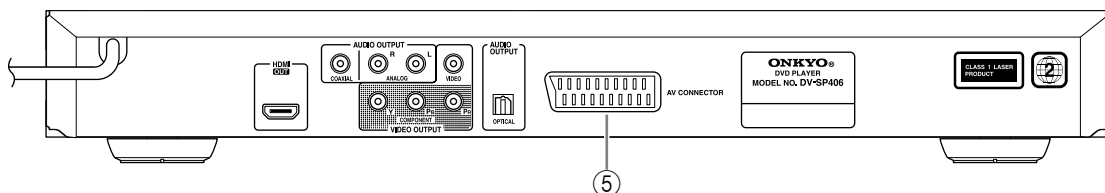

① HDMI OUT

This connector can be used to connect a TV, projector, or AV receiver with an HDMI input. This connector outputs digital audio and digital video.

② COAXIAL DIGITAL AUDIO OUT

This coaxial digital audio output can be connected to a coaxial digital audio input on a hi-fi amp, AV receiver, or surround sound decoder (Dolby Digital, DTS).

③ ANALOG AUDIO OUT

These connectors can be connected to analog audio inputs on your TV, hi-fi amp, or AV receiver.

④ VIDEO OUT

This connector can be used to connect a TV, projector, or AV receiver with a composite video input.

⑤ AV CONNECTOR (European model only)

This SCART output can be connected to a TV or projector with a SCART input. This SCART connector outputs 2-channel stereo audio, composite video, or RGB video.

⑥ OPTICAL DIGITAL AUDIO OUT

This optical digital audio output can be connected to an optical digital audio input on a hi-fi amp, AV receiver, or surround sound decoder (Dolby Digital, DTS).

⑦ COMPONENT VIDEO OUT

These sockets output component video and can be connected to an component video input on a TV, projector, or AV receiver.

⑧ S VIDEO VIDEO OUT (not European model)

This connector can be used to connect a TV, projector, or AV receiver with an S-Video input.

See page 15–19 for hook up information.

Remote control

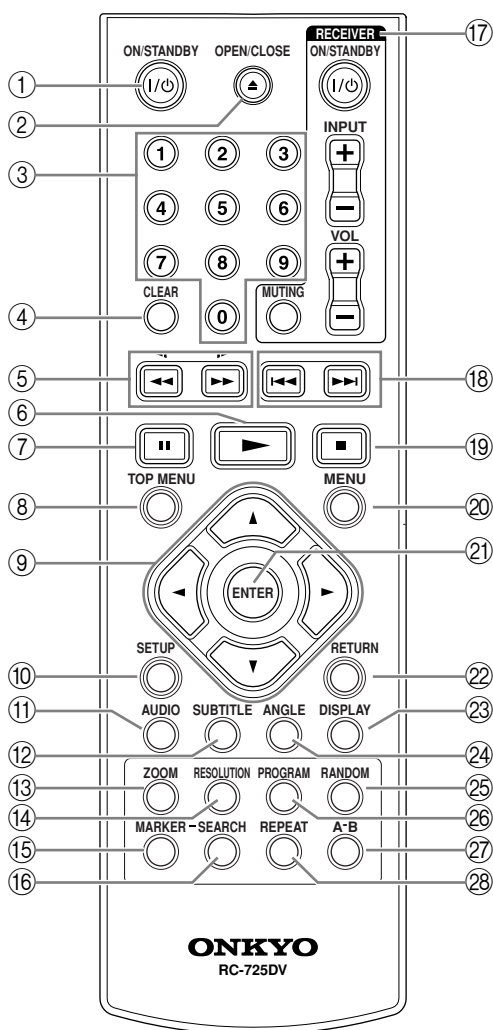

For detailed information, refer to the pages in parentheses.

- ① **ON/STANDBY [I/⏻] button (20)**
Sets the DVD player to On or Standby.
- ② **OPEN/CLOSE [▲] button (24, 27, 28, 30)**
Opens and closes the disc tray.
- ③ **Number buttons (26)**
Enters title, chapter, and track numbers and to enter times for locating specific points in time.
- ④ **CLEAR button (26, 31)**
Removes a track number on the Program List or a mark on the Marker Search menu.
- ⑤ **Fast Reverse/Fast Forward [◀◀]/[▶▶] buttons (25)**
Used for fast reverse and fast forward.
During pause, used to play slowly.

- ⑥ **[▶] (Play) button (24, 25, 27, 28, 30, 32)**
Starts playback.
- ⑦ **[⏸] (Pause) button (20, 24, 25, 30)**
Used to pause playback. While playback is paused, pressing this button moves the video forward one frame at a time.
- ⑧ **TOP MENU button (24, 26, 27, 28, 30, 32)**
Access the DVD menu.
- ⑨ **Cursor ◀/▶/▲/▼ buttons (21, 23, 26, 30, 32)**
Navigates onscreen menus.
- ⑩ **SETUP button (21)**
Opens and closes the onscreen setup menus.
- ⑪ **AUDIO button (25)**
Selects foreign language soundtracks and audio formats (e.g., Dolby Digital or DTS) on DVD-Video discs.
For Video CDs, you can select left-channel, right-channel, or stereo.
- ⑫ **SUBTITLE button (25)**
Selects subtitles on DVD-Video discs.
- ⑬ **ZOOM button (26, 31)**
Enlarges video image.
- ⑭ **RESOLUTION button (17)**
This button is used to select a video resolution for HDMI OUT.
- ⑮ **MARKER button (26)**
Marks any point during playback.
- ⑯ **SEARCH button (26)**
Displays MARKER SEARCH menu.
- ⑰ **RECEIVER**
Controls the Onkyo AV receiver.
ON/STANDBY button
Turns the AV receiver on or off.
INPUT +/- button
Selects the input source on the AV receiver.
VOL +/- button
Adjusts the volume of the AV receiver.
MUTING button
Mutes or unmutes the AV receiver.
Notes:
 - The ON/STANDBY and INPUT +/- buttons may not work with some models.
 - To control the AV receiver with this remote control, the AV receiver's Remote ID must be set to 1.
- ⑱ **Previous/Next [◀◀]/[▶▶] buttons (24, 30)**
The Previous button is used to select the previous chapter or track. During playback it selects the beginning of the current track.
The Next button is used to select the next chapter or track.

- ⑲ **[■] (Stop) button (24, 27, 28, 30, 32)**
Stops playback.
- ⑳ **MENU button (24, 26)**
Access the disc's title menu, if available.
- ㉑ **ENTER button (21–23, 26, 30, 32)**
Starts playback of the selected title, chapter, or track, and to confirm settings.
- ㉒ **RETURN button (32)**
Exits the onscreen setup.
- ㉓ **DISPLAY button (23, 26, 29)**
Accesses On-screen Display.
- ㉔ **ANGLE button (25)**
Selects camera angles on DVD-Video discs.
- ㉕ **RANDOM button (25)**
Used with the Random function.
- ㉖ **PROGRAM button (28)**
Used with the program edit mode.
- ㉗ **A-B button (25)**
Used to set the A-B Repeat function.
- ㉘ **REPEAT button (25)**
Used to set the Repeat function.

Connecting the DVD player

Before Making Any Connections

- Read the manuals supplied with your AV components.
- Don't connect the power cord until you've completed all audio and video connections.

Optical Digital Outputs

The DVD player's optical digital connectors have a shutter-type cover that opens when an optical plug is inserted, and closes when it's removed. Push the plug in all the way.

Caution: To prevent shutter damage, hold the optical plug straight when inserting and removing.

RCA AV Connection Color Coding

AV connections are usually color coded: red, white, and yellow. Use red plugs to connect right-channel audio inputs and outputs (typically labeled "R"). Use white plugs to connect left-channel audio inputs and outputs (typically labeled "L"). And use yellow plugs to connect composite video inputs and outputs.

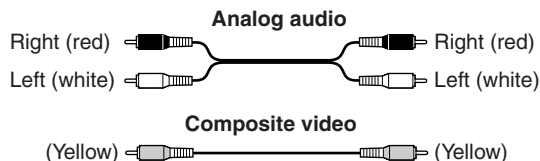

- Push each plug in all the way to make a good connection (loose connections can cause noise or malfunctions).
- To prevent interference, keep audio and video cables away from power cords and speaker cables.

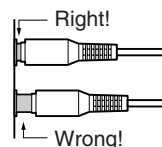

AV Cables & Connectors

Video			
Component video			Component video separates the luminance (Y) and color difference signals (PR, PB), providing the best picture quality. Some TV manufacturers label their component video inputs differently.
S-Video (not European model)			S-Video provides better picture quality than composite video.
Composite video			Composite video can be found on virtually all TVs, and video equipment.
Scart (European model only)			SCART connections carry audio and video all in one cable.

Audio			
Optical digital			Optical digital audio connections provide better audio quality than analog connections.
Coaxial digital			Coaxial digital audio connections provide better audio quality than analog connections.
Analog			RCA analog audio connectors can be found on virtually all AV components.

Connecting the DVD player—Continued

Audio and Video Connection

Connect the VIDEO OUT and AUDIO OUTPUT ANALOG L/R jacks to a set of A/V inputs on your TV.

The DVD player's audio/video jacks are color coded (yellow for video, red for right channel, white for left channel).

■ North American and Oceanian models

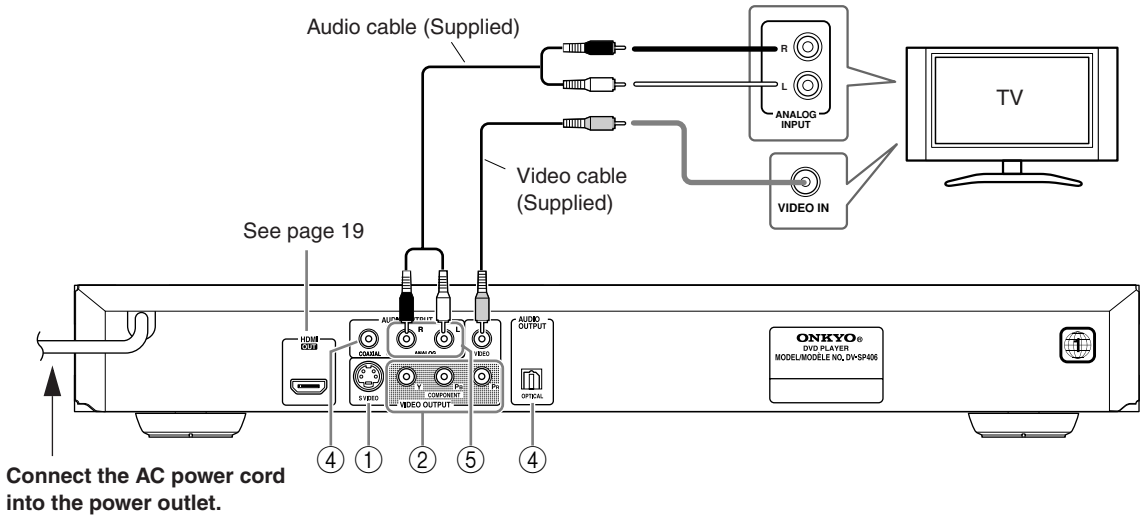

■ European model

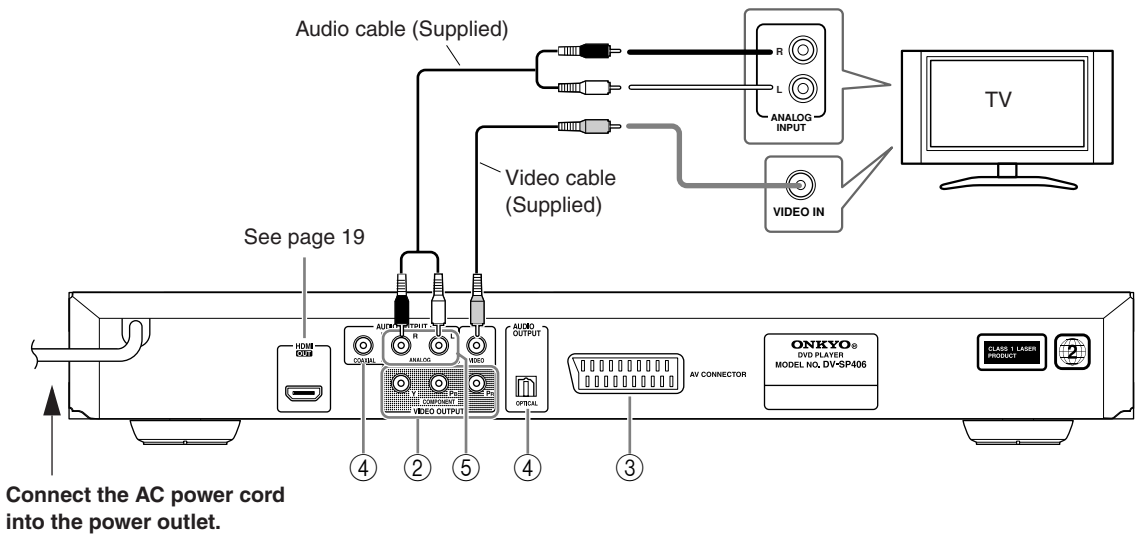

This player is equipped with copy protection technology. Do not connect this player to your TV via a VCR using AV cables, as the picture from this player will not appear properly on your TV. (This player may also not be compatible with some combination TV/VCRs for the same reason; refer to the manufacturer for more information.)

Connecting the DVD player—Continued

Hooking up the DVD player - more you can do

① S-Video connection (not European model)

Connect the S-VIDEO OUTPUT jack on the unit to the corresponding input jacks on your TV using a S-Video cable.

You will still need to connect the left and right audio cables to the TV, or digital audio cable to your stereo.

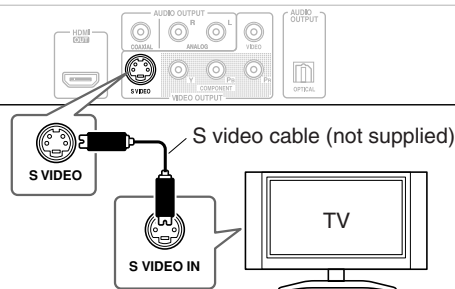

② Component Video Connections

Connect the COMPONENT OUTPUT jacks on the DVD player to the corresponding input jacks on your TV using a component video cable.

- You will still need to connect the left and right audio cables to the TV, or digital audio cable to your stereo.

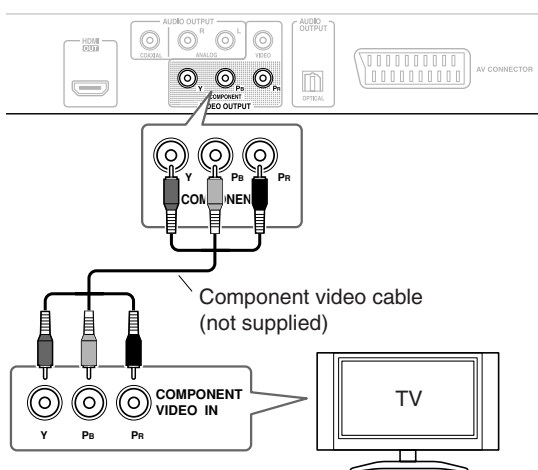

Resolution Setting

- You can change the resolution for component video output. Press RESOLUTION repeatedly to select the desired resolution - 480i, 480p, 720p, 1080i, 1080p.
- For 720p and 1080p resolution on the component video output, only non-copy protected discs can be played back. If the disc is copy protected, it will be displayed at the 480p resolution.

- Depending on your TV, some of the resolution settings may result in the picture disappearing or an abnormal picture appearing. In this case, press RESOLUTION repeatedly until the picture reappears.

Notes:

- Settings changed while the DVD player is On are saved to memory when the DVD player is set to Standby. If the DVD player's power cord is unplugged while the unit is still On, any changed settings will not be saved. Be aware of this when the DVD player is connected to a switched AC outlet on another component.
- On the European model, if you set the TV Output Select setting to RGB, the resolution will be fixed at 576i (see page 22).

③ SCART (European model only)

If your TV has a SCART-type AV input, you can use a SCART cable to connect this player to your TV. This type of connection carries both the sound and the picture, so there's no need to connect up the AUDIO OUTPUT L/R and VIDEO OUTPUT jacks.

- Use a SCART cable (not supplied) to connect the AV CONNECTOR to an AV input on your TV.

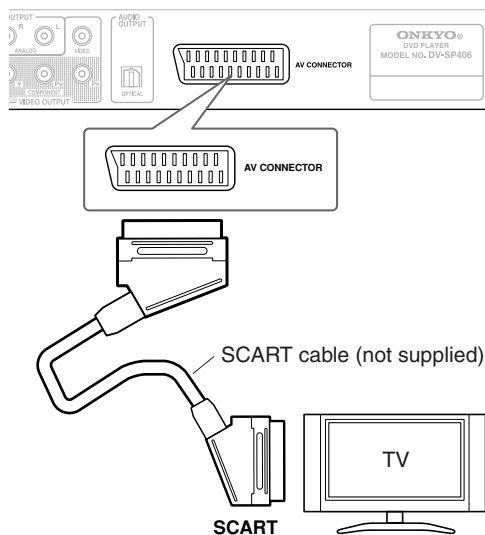

Connecting to an AV Receiver

Step 1: Audio Connection

You can connect the DVD player to your AV receiver using the 2-channel analog audio output or one of the digital audio outputs.

④ Digital Audio Output Connection

Connect one of the DVD player's DIGITAL AUDIO OUTPUT (OPTICAL or COAXIAL) jacks to the corresponding jack on your AV receiver.

- If the audio format of the digital output does not match the capabilities of your amplifier, the amplifier will produce a strong, distorted sound or no sound at all.
- To see the audio format of the current disc in the on-screen display, press AUDIO.
- This unit does not perform internal (2 channel) decoding of a DTS sound track. To enjoy DTS multi channel surround, you must connect this unit to a DTS compatible AV receiver via one of this unit's digital audio outputs.
- If your AV receiver doesn't support Dolby Digital and DTS, see page 22.

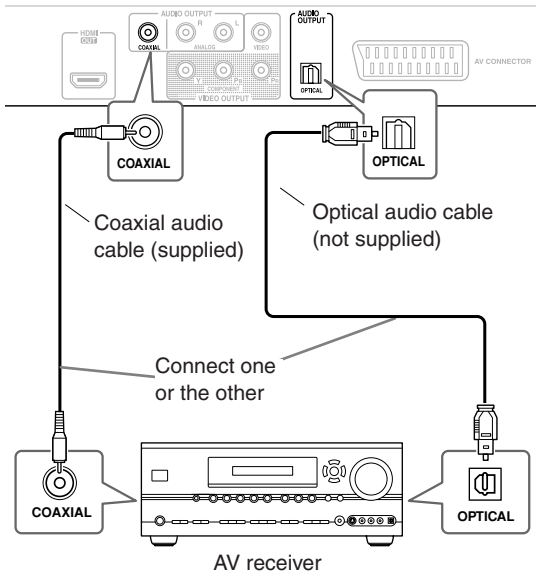

⑤ Analog Audio Connection

Connect the ANALOG AUDIO OUT L/R jacks on this player to a set of analog audio inputs on your AV receiver.

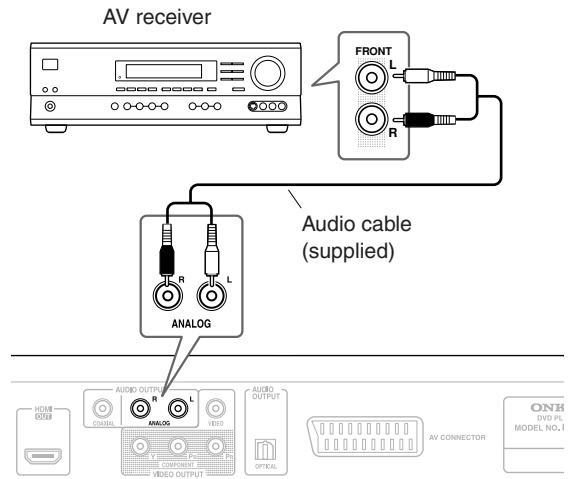

Step 2: Video Connection (See pages 16–17)

You may also want to connect the DVD player's video output to your AV receiver and connect the AV receiver's video output to a video input on your TV.

You can use any of the DVD player's video outputs. Typically, you must use the same type of video cable to connect your DVD player to your AV receiver as you do to connect your AV receiver to your TV.

Before Connecting

- Before making any connections, turn off the DVD player and AV receiver, and disconnect them from the wall outlets. Failure to do so may result in speaker damage.

Connection Hints

- To enjoy Dolby Digital or DTS surround sound, you must connect the DVD player to your AV receiver by using an optical or coaxial digital audio cable or HDMI cable. See page 19 for HDMI connection information.
- To record the audio from a CD-R disc to a cassette deck or CDR recorder that's connected to the AV receiver, or if you want to use your AV receiver's Zone 2 function, you must connect the DVD player's stereo analog audio output to your AV receiver.

Connecting the DVD player—Continued

HDMI Connection

Connect the HDMI OUTPUT jack on the unit to the HDMI input jack on an HDMI compatible TV using an HDMI cable.

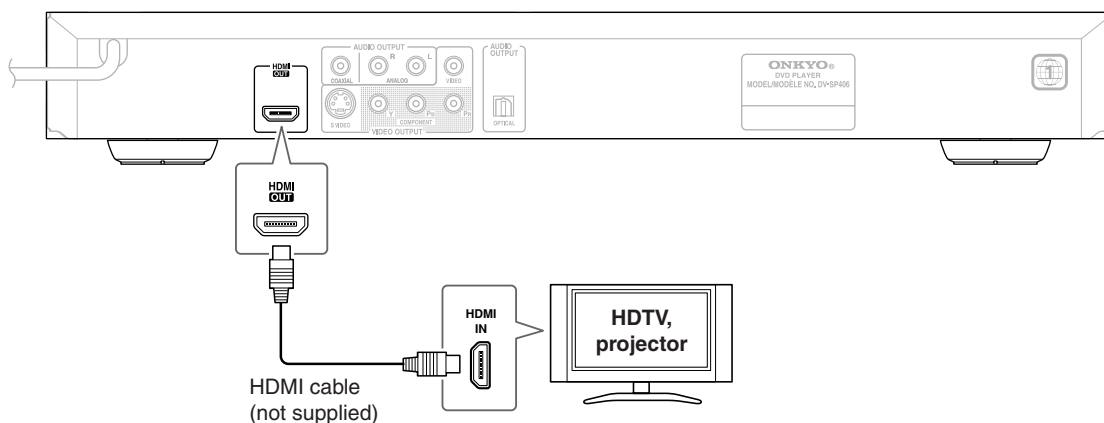

Hooking up the DVD player - more you can do

■ Resolution Setting

You can change the resolution for HDMI output. Press RESOLUTION repeatedly to select the desired resolution - 480i, 480p, 720p, 1080i, 1080p.

■ Note for 1080p resolution

The DVD player is able to provide a 1080p full HD image to most 1080p-capable TVs in the market today. However, there are some 1080p TVs available from certain companies that are limited in the types of 1080p images that can be accepted.

Specifically, 1080p-capable TVs that don't accept images in 60Hz can't display an image from this DVD player.

■ About HDMI

HDMI (High Definition Multimedia Interface) supports both video and audio on a single digital connection for use with DVD Players, Set-Top Boxes, and other AV devices. HDMI was developed to provide the technologies of HDCP (High-bandwidth Digital Content Protection). HDCP is used to protect digital content transmitted and received.

HDMI has the capability to support standard, enhanced or high-definition video plus standard to multi-channel surround-sound audio, HDMI features include uncompressed digital video, a bandwidth of up to 5 gigabytes per second, one connector (instead of several cables and connectors), and communication between the AV source and AV devices such as DTVs.

This DVD player supports HDMI version 1.1.

■ Notes on HDMI connection

- If your TV is not capable of handling 96 kHz sampling frequency, set the [Sampling Freq.] option to [48 kHz] on the setup menu (See page 22).
- If your TV is not equipped with Dolby Digital and MPEG decoder, set the [Dolby Digital] and [MPEG] options to [PCM] on the setup menu (See page 22).
- Depending on your TV, some of the resolution settings may result in the picture disappearing or an abnormal picture appearing. In this case, press RESOLUTION repeatedly until the picture re-appears.
- Changing the resolution when the DVD player is connected with HDMI connector may result in malfunctions. To solve the problem, turn off the unit and then turn it on again.
- When you connect a HDMI or DVI compatible device make sure of the following:
 - Try switching off the HDMI/DVI device and this unit. Next, switch on the HDMI/DVI device and leave it for around 30 seconds, then switch on this unit.
 - The connected device's video input is set correctly for this unit.
 - The connected device is compatible with 720x480i, 720x480p, 1280x720p, 1920x1080i or 1920x1080p video input.
 - The 1080p, 720p and 480p resolutions are the progressive scan applied resolution.
- Not all HDCP-compatible DVI devices will work with this unit.
 - The picture will not be displayed properly with non-HDCP device.

Connecting the Power/Turning on the DVD player

Before connecting

- Make sure that all the connections on pages 15–19 are complete (the connection to a TV is required).

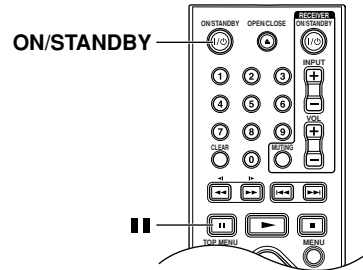
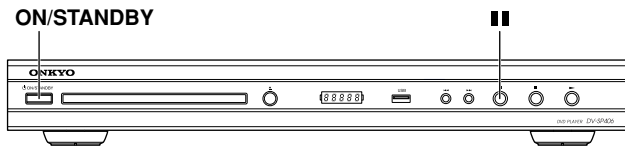

- | | |
|----------|--|
| 1 | Connect the power cord into the power outlet on the wall. |
| 2 | <p>Press ON/STANDBY on the DVD player or ON/STANDBY on the remote controller.
The DVD Player turns on.</p> <ul style="list-style-type: none"> • To put the DVD player in the standby mode, press ON/STANDBY on the DVD player, or ON/STANDBY on the remote controller. Be sure to set the volume to minimum before putting the DVD player in the standby mode for the next use to avoid sudden loud sound reproduction. • Setting the ON/STANDBY to standby does not shut off the power completely. • The DVD player will turn on automatically if the OPEN/CLOSE or [▶▶] (Play) on the remote controller is pressed while the unit is on Standby. |



Setting the TV system (Not North American model)

If you experience picture distortion with some discs, or a picture is black, set the TV system to match your country or region's system.





Notes:

- Settings changed while the unit is On are saved to memory when the unit is set to Standby. If the unit's power cord is unplugged while the unit is still On, any changed settings will not be saved. Be aware of this when the unit is connected to a switched AC outlet on another component.
- While a disc is loaded, the TV system cannot be switched. Unload a disc to switch the TV system.

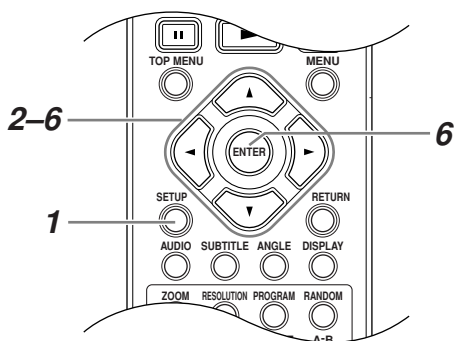
<p>Two small illustrations. The top one shows a hand's index finger pressing the pause button (two vertical bars) on the front of the DVD player. The bottom one shows a hand's index finger pressing the pause button on the remote control.</p>	<p>With no disc loaded, press [] (Pause) for 5 seconds to switch between PAL and NTSC.</p>
---	---

Adjust the settings

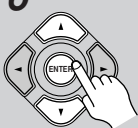

1 	Display setup menu: SETUP
2 	Select a desired option on the first level: [▲]/[▼]
3 	Move to second level: [▶]
4 	Select a desired option on the second level: [▲]/[▼]
5 	Move to third level: [▶]
6 	Change the setting: [▲]/[▼] / ENTER

If there's no picture on your TV, the TV system (PAL/NTSC) setting on the DV-SP406 may be different to the TV system supported by your TV.

In this case, press and hold down [||] (Pause) on the DV-SP406 or remote controller to switch between PAL and NTSC. The North American model is fixed at NTSC, so pressing [||] (Pause) has no effect.

Note:

- Settings changed while the unit is On are saved to memory when the unit is set to Standby. If the unit's power cord is unplugged while the unit is still On, any changed settings will not be saved. Be aware of this when the unit is connected to a switched AC outlet on another component.

Adjust the settings - more you can do

If the language selection menu doesn't appear, make sure the TV system setting (PAL, NTSC) (see page 20).

Adjust the language settings

Menu Language – Select a language for the Setup menu and on-screen display.

Disc Audio/Subtitle/Menu – Select a language for the Disc Audio/Subtitle/Menu.

[Original]: Refers to the original language in which the disc was recorded.

[Other]: To select another language, press number buttons then **ENTER** to enter the corresponding 4-digit number according to the language code list (see page 33). If you make a mistake while entering number, press **CLEAR** to delete numbers then correct it.

[Off] (for Disc Subtitle):
Turn off Subtitle.

Adjust the display settings

TV Aspect – Select which screen aspect to use based on the shape of your TV screen.

[4:3]: Select when a standard 4:3 TV is connected.

[16:9]: Select when a 16:9 wide TV is connected.

Display Mode – If you selected 4:3, you'll need to define how you would like widescreen programs and films to be displayed on your TV screen.

[Letterbox]:

This displays a wide-screen picture with black bands at the top and bottom of the screen.



[Panscan]:

This fills the entire 4:3 screen, cropping the picture as necessary.



Adjust the settings—Continued

If you selected 16:9, you'll need to define how you would like widescreen programs and films to be displayed on your TV screen.

[16:9 Widescreen]:

Choose this option if you have a widescreen TV (16:9 aspect ratio). Depends on TV, the picture appears stretched when watching programs in 4:3 format.

[16:9 Compressed]:

Choose this option if you have a widescreen TV (16:9 aspect ratio) and the picture appears stretched when watching programs in 4:3 format. This option will correct the issue.



If you select 16:9, you must also select one of the following settings.

TV Output Select (European model only)

With this setting, you can choose the video output you want to use to output component video. Before changing this setting, refer to your TV's manual to see if its SCART input supports RGB.

RGB: RGB component video is output by the SCART AV CONNECTOR.

YPbPr: YPbPr component video is output by the COMPONENT VIDEO OUT.

Note:

- When YPbPr is selected, composite video is output by the SCART AV CONNECTOR.

Adjust the audio settings

Dolby Digital / DTS / MPEG – Selects the type of digital audio signal when using the DIGITAL AUDIO OUTPUT jack.

[Bitstream]:

Select this when you connect this unit's DIGITAL AUDIO OUTPUT jack to an amplifier with a built-in Dolby Digital, DTS or MPEG decoder.

[PCM] (for Dolby Digital / MPEG):

Select this when you connect this unit's DIGITAL AUDIO OUTPUT jack to an amplifier without a built-in Dolby Digital or MPEG decoder.

[Off] (for DTS):

Select this when you connect this unit's DIGITAL AUDIO OUTPUT jack to an amplifier without a built-in DTS decoder.

Sample Freq. (Frequency) – Selects the sampling frequency of the audio signal.

[48 KHz]: The audio signals are always converted to 48 kHz.

[96 KHz]: The audio signals are output in their original format.

DRC (Dynamic Range Control) – Make the sound clear when the volume is turned down (Dolby Digital only). Set to [On] for this effect.

Note:

- Settings changed while the unit is On are saved to memory when the unit is set to Standby. If the unit's power cord is unplugged while the unit is still On, any changed settings will not be saved. Be aware of this when the unit is connected to a switched AC outlet on another component.

Adjust the lock settings

You must set the [Area Code] option to use the lock options. Select [Area Code] option then press [▶]. Enter a 4-digit password then press **ENTER**. Enter it again then press **ENTER** to verify. If you make a mistake while entering number, press **CLEAR** then correct it.

If you forget your password you can reset it. Display setup menu then input the 6-digit number "210499". The "P CLr" appear in the display window and the password is deleted.

Rating – Select a rating level. The lower the level, the stricter the rating. Select [Unlock] to deactivate the rating.

Password – Sets or changes the password for lock settings.

[New]: Enter a new 4-digits password using the numerical buttons then press **ENTER**. Enter the password again to confirm.

[Change]: Enter the new password twice after entering the current password.

Area Code – Select a code for a geographic area as the playback rating level.

This determines which area's standards are used to rate DVDs controlled by the parental lock (see page 33).

Adjust the others settings

PBC (Playback Control) – Playback control provides special navigation features that are available on some Video CDs. Select [On] to use this feature.

B.L.E. (Black Level Expansion) – To select the black level of playback pictures. Set your preference and monitor's ability.

DivX(R) VOD – We provide you with the DivX® VOD (Video On Demand) registration code that allows you to rent and purchase videos using the DivX® VOD service. For more information, visit www.divx.com/vod.

Press **ENTER** when [Select] icon is highlighted and you can view the registration code of the unit. All the downloaded videos from DivX® VOD can only be played back on this unit.

Displaying Disc Information

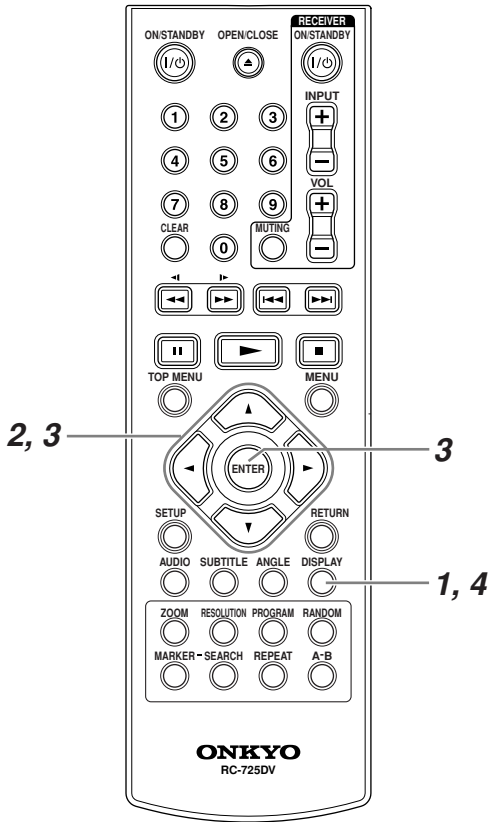







Displaying Disc Information - more you can do

You can select an item by pressing [▲]/[▼] and change or select the setting by pressing [◀]/[▶].





Note:

- For DVD, VCD, and DivX discs, the following window appears. Depending on the disc, not all of the items may be displayed. For MP3 and WMA discs, the ID3 tag changes.

 1/6	Current title (or track) number/total number of titles (or tracks)
 5/42	Current chapter number/total number of chapters
 0:13:45	Elaps playing time
 1 ENG 3/2.1CH	Selected audio language or channel
 OFF	Selected subtitle
 1/1	Selected angle/total number of angles





Symbol Used in this Manual

ALL	All discs and file listed below
ACD	Audio CDs
DVD	DVD and finalized DVD±R/RW
VCD	Video CDs
MP3	MP3 files
DivX	DivX files
WMA	WMA files

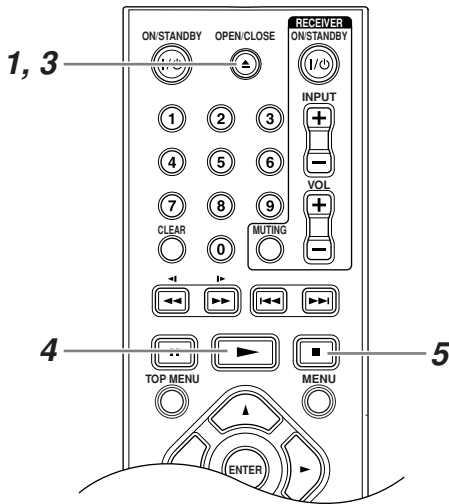
1 DISPLAY 	Press DISPLAY: DISPLAY
2 	Select a item: [▲]/[▼]
3 	Adjust the Display menu settings: [◀]/[▶] / ENTER
4 DISPLAY 	To return the exit: DISPLAY

Playing a Disc



1 OPEN/CLOSE 	Open the disc tray: ▲ OPEN/CLOSE
2	Insert a Disc: - Load a disc with the label side facing up, using the disc tray guide to align the disc.
3 OPEN/CLOSE 	Close the disc tray: ▲ OPEN/CLOSE
4 	Start playback: ►
5 	To stop playback: ■

Playing a Disc - more you can do

If there's no picture on your TV, the TV system (PAL/NTSC) setting on the DV-SP406 may be different to the TV system supported by your TV.

In this case, press and hold down [||] (Pause) on the DV-SP406 or remote controller to switch between PAL and NTSC. The North American model is fixed at NTSC, so pressing [||] (Pause) has no effect.

Stops the playback

The DV-SP406 records the stopped point depending on the disc.

“|| ■” appears on the screen briefly. Press [►] to resume playback (from the scene point).

If you press [■] again or unload the disc (“■” appears on the screen), the unit will clear the stopped point.

(||=Resume Stop, ■ =Complete Stop) The resume point may be cleared when the ON/STANDBY button is pressed.

Playing a DVD or Video CD that has a menu

DVD VCD

Most DVD or Video CD now have menus which load first before the film begins to play. You can navigate these menus using [▲]/[▼]/[◀]/[▶] or number button to highlight an option. Press ENTER to select.

Playing a DVD VR disc

This unit will play DVD-RW disc that is recorded using the Video Recording (VR) format.

When you insert a disc DVD VR disc, the menu will appear on the screen. Use [▲]/[▼] to select a title then press [►]. To display DVD-VR menu, press TOP MENU or MENU.

Some DVD-VR disc are made with CPRM data by DVD RECORDER. Player does not support these kinds of discs.

Skip to the next/previous chapter/track

ALL

Press [►►] to move to the next chapter/track.

Press [◄◄] to return to the beginning of the current chapter/track.

Press [◄◄] twice briefly to step back to the previous chapter/track.

Pause a playback ALL

Press [||] to pause playback. Press [►] to continue playback.

Frame-by-Frame playback

DVD DivX VCD

Press [III] repeatedly to play Frame-by-Frame playback.

Fast forward or fast reverse

DVD DivX VCD ACD WMA MP3

Press [◀◀] or [▶▶] to play fast forward or fast reverse during playback.

You can change the various playback speed by pressing [◀◀] or [▶▶] repeatedly. Press [▶] to continue play at normal speed.

For DVD and DivX discs, four speeds are available. For other discs, three speeds are available.

Playing repeatedly **ALL**

REPEAT



To return to normal playback, press **REPEAT** repeatedly to select [Off].

On a Video CD with PBC, you must set PBC to [Off] to use this function (see page 22).

- For DivX, MP3, and WMA discs, when you select the Repeat All while the track in the folder is playing repeat play starts within the folder.

DVD: Chapter, title

VCD, DivX, CD, MP3, WMA: Track, All

Random Play

ACD MP3 WMA

RANDOM



Press **RANDOM**.

Random playback starts.

To cancel random playback, press **RANDOM** again.

Notes:

- Random Repeat playback is possible with CD, MP3, and WMA discs. During random playback, press **REPEAT**.
- For MP3 and WMA discs, all of the files in the folder containing the currently selected file will be played randomly.

Repeating a specific portion (A-B)

DVD DivX VCD ACD



Press **A-B** at the beginning of the portion you wish to repeat and again at the end of the portion.

Your selected portion will be repeated continually.

To return to normal playback, press **A-B** to select [Off].

Selecting a subtitle language **DVD**

During playback, press **SUBTITLE** repeatedly to select a desired subtitle language.

Watching from a different angle **DVD**

If the angle indicator appears on the screen for a moment, you can select a different camera angle by pressing **ANGLE** repeatedly.

Hearing a different audio

DVD DivX VCD

During playback, press **AUDIO** repeatedly to switch between the available audio languages, channels or encoding methods.

For VCD disc, press **AUDIO** to switch its L, R, and stereo channels.

Slow down the playing speed

DVD DivX VCD



While playback is paused, press [◀◀] or [▶▶] to slow down reverse or forward playback.

You can change the various playback speed by pressing [◀◀] or [▶▶] repeatedly. Press [▶] to continue play at normal speed.

Four playback speeds are available. Only forward playback can be slowed down for DivX and VCD discs.

Watching an enlarged video image

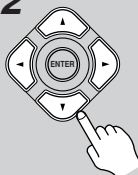
DVD DivX VCD

1 	During playback or pause mode, press ZOOM repeatedly to select zoom mode.
2  	You can move through the zoomed picture using [▲]/[▼]/[◀]/[▶] buttons. Press CLEAR to exit.



Viewing the title menu **DVD**

Press **MENU** to display the disc's title menu, if available.

Viewing the DVD menu **DVD**

Press **TOP MENU** to display the disc menu, if available.

Marking a favorite scene **DVD DivX VCD**

1 	You can mark positions by pressing MARKER at the desired position up to 9 markers.
2  	Also you can recall or clear positions by pressing SEARCH . Use [◀] or [▶] to select a desired marker on the [MARKER SEARCH] menu, then press ENTER to recall it or CLEAR to clear it.

Starting play from selected time

DVD DivX VCD

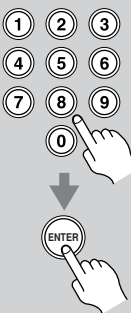
1	Searches for the starting point of entered time code.
2 	Press DISPLAY then select clock icon.
3 	Enter a time then press ENTER . For example, to find a scene at 1 hours, 10 minutes, and 20 seconds, enter "11020" and press ENTER . If you enter the wrong number, press CLEAR to enter again.

Last Scene Memory

DVD ACD VCD 1.1

This unit memorizes last scene from the last disc that is viewed. The last scene remains in memory even if you remove the disc from the player or switch off the unit. If you load a disc that has the scene memorized, the scene is automatically recalled.

Screen Saver

The screen saver appears when you leave the unit in Stop mode for about five minutes. If the Screen Saver is displayed for five minutes, the unit automatically turns itself off.

Mixed disc or (USB Flash Drive_ European and other models only) -DivX, MP3/WMA and JPEG

When playing a disc or USB Flash Drive contained with DivX, MP3/WMA and JPEG files together, you can select which menu of files you would like to play by pressing **TOP MENU**.

Playing a DivX movie file

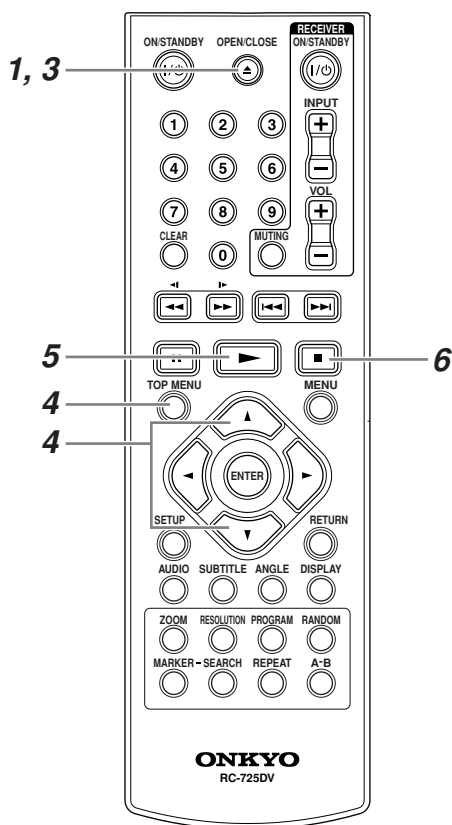

4	Select a movie file from the menu: [▲]/[▼], TOP MENU
5	Start playback: ►
6	To stop playback: ■

1 OPEN/CLOSE	Open the disc tray: ▲ OPEN/ CLOSE
2	Insert a disc: -
3 OPEN/CLOSE	Close the disc tray: ▲ OPEN/ CLOSE

Playing a DivX movie file - more you can do

DivX file requirement

DivX file compatibility with this player is limited as follows:

- Available resolution size: 720x576 (W x H) pixel
- The file names of DivX and subtitle are limited to 56 characters.
- DivX file extensions: “.avi”, “.mpg”, “.mpeg”
- Playable Codec format: “DIVX3.xx”, “DIVX4.xx”, “DIVX5.xx”, “MP43”, “3IVX”, “XviD”
- Only the playback function is supported with DivX 6.0 in the unit.
- Playable Audio format: “Dolby Digital”, “DTS”, “PCM”, “MP3”, “WMA”
- Sampling frequency: within 8 - 48 kHz (MP3), within 22 - 48 kHz (WMA)
- Bit rate: within 8 - 320 kbps (MP3), within 32 - 256 kbps (WMA), less than 8Mbps (DivX file)
- CD-R/RW, DVD±R/RW Format: ISO 9660
- Maximum Files/Disc: Less than 650 (total number of files and folders)

Listening to Music Disc or files

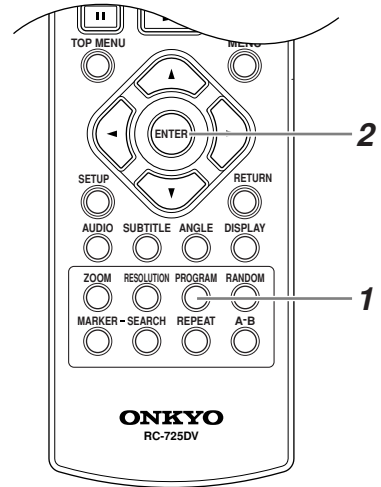
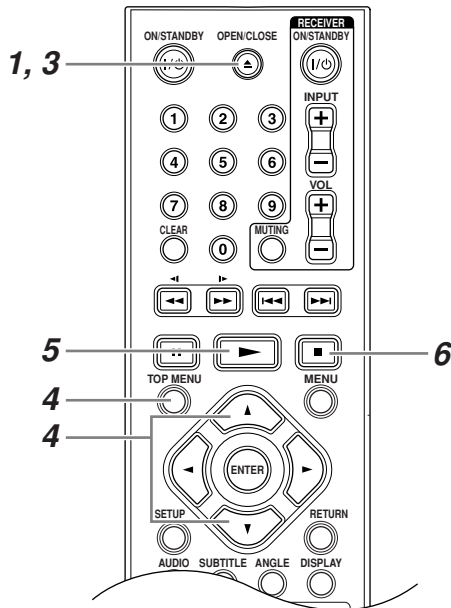

<p>1</p> <p>OPEN/CLOSE</p>	<p>Open the disc tray: ▲ OPEN/CLOSE</p>
<p>2</p>	<p>Insert a disc: -</p>
<p>3</p> <p>OPEN/CLOSE</p>	<p>Close the disc tray: ▲ OPEN/CLOSE</p>
<p>4</p> <p>TOP MENU</p>	<p>Select a music from the menu: [▲]/[▼], TOP MENU</p>
<p>5</p>	<p>Start playback: ►</p>
<p>6</p>	<p>To stop playback: ■</p>

Listening to Music Disc or files - more you can do

Creating your own program

ACD MP3 WMA

You can play the contents of a disc in the order you want by arranging the order of the musics on the disc.

<p>1</p> <p>PROGRAM</p>	<p>To add a music(s) on the program list, press PROGRAM to enter the program edit mode (Ⓜ mark appears on the menu).</p>
<p>2</p>	<p>Select a desired music on the [List] then press ENTER to add the music to the program list.</p> <p>Select a music from the program list then press ENTER to start programmed playback.</p>
<p>To clear a music from the program list, select the music you want to clear then press CLEAR in program edit mode.</p> <p>To clear all music from the program list, select [Clear All] then press ENTER in program edit mode. The program is cleared when the disc is removed or the unit is turned off.</p>	

Displaying file information (ID3 TAG)

While playing a MP3 file containing file information, you can display the information by pressing **DISPLAY** repeatedly.

MP3/WMA music file requirement

MP3/WMA compatibility with this unit is limited as follows:

- Discs must be finalized.
- The DVD player can only recognize the first session on multisession discs.
- File extensions: “.mp3”, “.wma”
- Sampling frequency: within 8 - 48 kHz (MP3), within 22 - 48kHz (WMA)
- Bit rate: within 8 - 320kbps (MP3), within 32 - 256kbps (WMA)
- CD-R/RW, DVD±R/RW Format: ISO 9660
- Maximum Files/Disc: Less than 650 (total number of files and folders)
- VBR WMA playback: No
- WMA lossless encoding compatible: No
- DRM (Digital Rights Management) compatible: No (DRM-protected audio files will not play in this player—see also DRM in the “Glossary” on page 34)

Viewing photo files

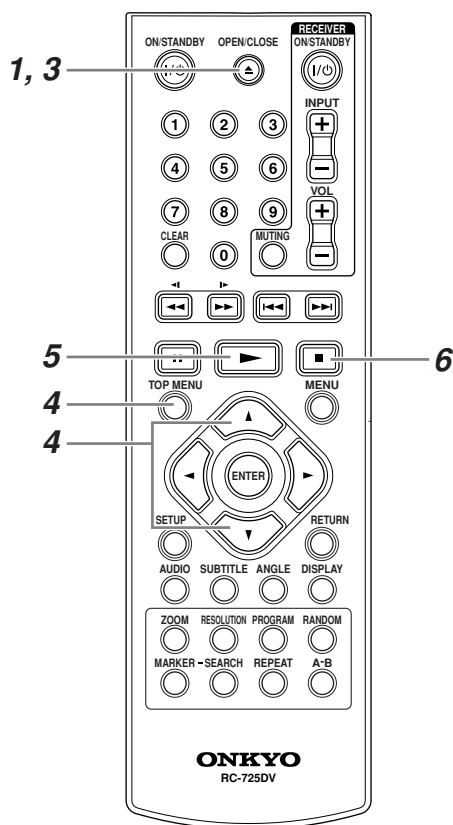

<p>1</p> <p>OPEN/CLOSE</p>	<p>Open the disc tray: ▲ OPEN/ CLOSE</p>
<p>2</p>	<p>Insert a disc: -</p>
<p>3</p> <p>OPEN/CLOSE</p>	<p>Close the disc tray: ▲ OPEN/ CLOSE</p>
<p>4</p> <p>TOP MENU</p>	<p>Select a photo file on the menu: [▲]/[▼], TOP MENU</p>

<p>5</p>	<p>Display the selected file in full screen: ▶</p>
<p>6</p>	<p>To return to the menu: ■</p>

Viewing photo files - more you can do

Viewing photo files as a slide show

Use [▲]/[▼]/[◀]/[▶] to highlight () icon then press **ENTER** to start slide show.

You can change slide show speed using [◀]/[▶] when () icon is highlighted.

Skip to the next/previous photo

Press [◀◀] or [▶▶] to view the previous/next photo.

Rotate a photo

Use [▲]/[▼] to rotate the photo in full screen counter-clockwise or clockwise while viewing a photo in full screen.

Pause a slide show

Press [||] to pause a slide show. Press [▶] to continue the slide show.

Listening to music during slide show

You can listen to music during slide show, if the disc contain music and photo files together. Use [▲]/[▼]/[◀]/[▶] to highlight () icon then press **ENTER** to start slide show.

You cannot select a music during slide show. However, the music you want to listen can be selected by making a program.

[◀◀]/[▶▶], [◀◀◀]/[▶▶▶], RANDOM, REPEAT, and A-B REPEAT will not work during playback.

Watching an enlarged photo image

While viewing a photo in full screen, press **ZOOM** repeatedly to select zoom mode. You can move through the zoomed photo using [**▲**]/[**▼**]/[**◀**]/[**▶**] buttons.

Press **CLEAR** to exit.

Photo file requirement



JPEG file compatibility with this unit is limited as follows:



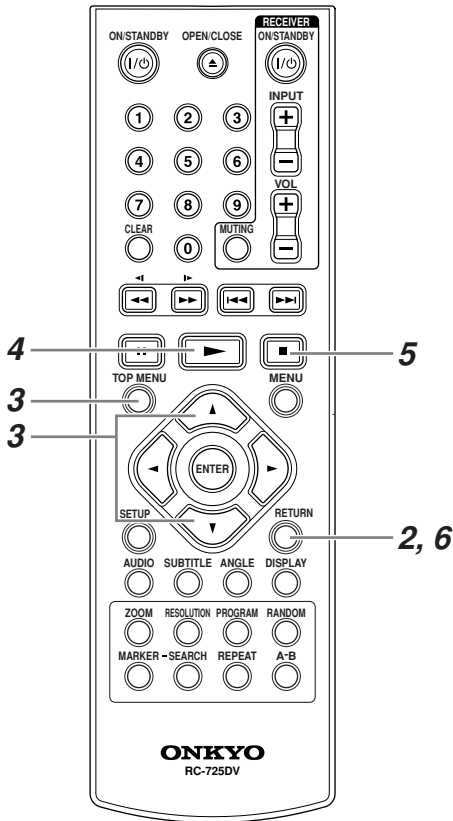
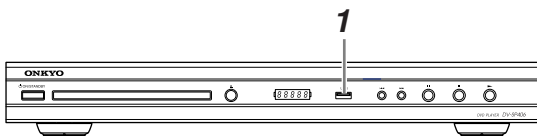

- Discs must be finalized.
- The DVD player can only recognize the first session on multisession discs.
- File extensions: “.jpg”
- Photo size: Less than 5M recommended
- CD-R/RW, DVD±R/RW Format: ISO 9660
- Maximum Files/Disc: Less than 650 (total number of files and folders)

Using an USB Flash Drive (European & Other models only)

You can play MP3/WMA/JPEG/DivX files in the USB Flash Drive with version 1.1.

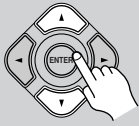

1 USB 	Connect an USB Flash Drive to the USB port on the unit: -
2 RETURN 	Display the menu screen in stop mode: RETURN

3  TOP MENU 	Select a file: [▲]/[▼], TOP MENU
4 	Play the file: ►
5 	Stop the file: ■
6 RETURN 	Turn the USB port off: RETURN Remove an USB Flash Drive.

Notes an USB Flash Drive

- You can switch USB and DISC mode by pressing **RETURN** only in stop mode.
- Do not extract the USB device in operating.
- Aback up demands to prevent a data damage.
- If you use a USB extension cable or USB HUB, the USB device might not be recognized.
- Music files (MP3/WMA), photo files (JPEG) and DivX files can be played.
For details of operations on each files, refer to relevant pages.
- This unit is not supported when the total number of files is more than 650.
- The USB function of this unit does not support all kinds of USB devices.
- Digital camera and mobile phone are not supported.
- Onkyo cannot be held responsible for damage to the USB device or for loss of data.

Language Codes

Use this list to input your desired language for the following initial settings: Disc Audio, Disc Subtitle, Disc Menu.

Language	Code
Afar	6565
Afrikaans	6570
Albanian	8381
Ameharic	6577
Arabic	6582
Armenian	7289
Assamese	6583
Aymara	6588
Azerbaijani	6590
Bashkir	6665
Basque	6985
Bengali; Bangla	6678
Bhutani	6890
Bihari	6672
Breton	6682
Bulgarian	6671
Burmese	7789
Byelorussian	6669
Chinese	9072
Croatian	7282
Czech	6783
Danish	6865
Dutch	7876
English	6978
Esperanto	6979
Estonian	6984
Faroese	7079
Fiji	7074
Finnish	7073

Language	Code
French	7082
Frisian	7089
Galician	7176
Georgian	7565
German	6869
Greek	6976
Greenlandic	7576
Guarani	7178
Gujarati	7185
Hausa	7265
Hebrew	7387
Hindi	7273
Hungarian	7285
Icelandic	7383
Indonesian	7378
Interlingua	7365
Irish	7165
Italian	7384
Javanese	7487
Kannada	7578
Kashmiri	7583
Kazakh	7575
Kirghiz	7589
Korean	7579
Kurdish	7585
Laothian	7679
Latin	7665
Latvian, Lettish	7686
Lingala	7678

Language	Code
Lithuanian	7684
Macedonian	7775
Malagasy	7771
Malay	7783
Malayalam	7776
Maori	7773
Marathi	7782
Moldavian	7779
Mongolian	7778
Nauru	7865
Nepali	7869
Norwegian	7879
Oriya	7982
Panjabi	8065
Pashto, Pushto	8083
Persian	7065
Polish	8076
Portuguese	8084
Quechua	8185
Rhaeto-Romance	8277
Rumanian	8279
Russian	8285
Samoan	8377
Sanskrit	8365
Scots Gaelic	7168
Serbian	8382
Serbo-Croatian	8372
Shona	8378
Sindhi	8368

Language	Code
Singhalese	8373
Slovak	8375
Slovenian	8376
Spanish	6983
Sudanese	8385
Swahili	8387
Swedish	8386
Tagalog	8476
Tajik	8471
Tamil	8465
Telugu	8469
Thai	8472
Tonga	8479
Turkish	8482
Turkmen	8475
Twi	8487
Ukrainian	8575
Urdu	8582
Uzbek	8590
Vietnamese	8673
Volapük	8679
Welsh	6789
Wolof	8779
Xhosa	8872
Yiddish	7473
Yoruba	8979
Zulu	9085

Area Codes

Choose a area code from this list.

Area	Code
Afghanistan	AF
Argentina	AR
Australia	AU
Austria	AT
Belgium	BE
Bhutan	BT
Bolivia	BO
Brazil	BR
Cambodia	KH
Canada	CA
Chile	CL
China	CN
Colombia	CO
Congo	CG
Costa Rica	CR
Croatia	HR
Czech Republic	CZ
Denmark	DK
Ecuador	EC
Egypt	EG
El Salvador	SV

Area	Code
Ethiopia	ET
Fiji	FJ
Finland	FI
France	FR
Germany	DE
Great Britain	GB
Greece	GR
Greenland	GL
Hong Kong	HK
Hungary	HU
India	IN
Indonesia	ID
Israel	IL
Italy	IT
Jamaica	JM
Japan	JP
Kenya	KE
Kuwait	KW
Libya	LY
Luxembourg	LU
Malaysia	MY

Area	Code
Maldives	MV
Mexico	MX
Monaco	MC
Mongolia	MN
Morocco	MA
Nepal	NP
Netherlands	NL
Netherlands Antilles	AN
New Zealand	NZ
Nigeria	NG
Norway	NO
Oman	OM
Pakistan	PK
Panama	PA
Paraguay	PY
Philippines	PH
Poland	PL
Portugal	PT
Romania	RO
Russian Federation	RU
Saudi Arabia	SA

Area	Code
Senegal	SN
Singapore	SG
Slovak Republic	SK
Slovenia	SI
South Africa	ZA
South Korea	KR
Spain	ES
Sri Lanka	LK
Sweden	SE
Switzerland	CH
Taiwan	TW
Thailand	TH
Turkey	TR
Uganda	UG
Ukraine	UA
United States	US
Uruguay	UY
Uzbekistan	UZ
Vietnam	VN
Zimbabwe	ZW

Glossary

Analog audio

An electrical signal that directly represents sound. Compare this to digital audio which can be an electrical signal, but is an indirect representation of sound. See also “Digital audio”.

Aspect ratio

The width of a TV screen relative to its height. Conventional TVs are 4:3 (in other words, the screen is almost square); widescreen models are 16:9 (the screen is almost twice as wide as it is high).

Digital audio

An indirect representation of sound by numbers. During recording, the sound is measured at discrete intervals (44,100 times a second for CD audio) by an analog-to-digital converter, generating a stream of numbers.

On playback, a digital-to-analog converter generates an analog signal based on these numbers. See also “Sampling frequency” and “Analog audio”.

DivX

DivX is a media technology created by DivX, Inc. DivX media files contain compressed video. DivX files can also include advanced media features like menus, subtitles, and alternate audiotracks.

Dolby Digital

Using a maximum of 5.1 channels of audio, this high quality surround system is used in many of the finer movie theaters around the world.

The on-screen display shows which channels are active, for example showing 3/2.1. The 3 being the two front channels and the center channel; the 2 being the surround channels, and the .1 being the LFE channel.

DRM

DRM (digital rights management) is a type of server software developed to enable secure distribution of paid content over the web, recently incorporated by WMA (Windows Media Audio).

DTS

DTS stands for Digital Theater Systems. DTS is a surround system different from Dolby Digital that has become a popular surround sound format for movies.

Dynamic range

The difference between the quietest and loudest sounds possible in an audio signal (without distorting or getting lost in noise).

Dolby Digital and DTS soundtracks are capable of a very wide dynamic range, delivering dramatic cinema-like effects.

EXIF (Exchangeable Image File)

A file format developed by Fuji Photo Film for digital still cameras. Digital cameras from various manufacturers use this compressed file format which carries date, time and thumbnail information, as well as the picture data.

File extension

A tag added to the end of a filename to indicate the type of file. For example, “.mp3” indicates an MP3 file.

HDMI

HDMI (High-Definition Multimedia Interface) is a high-speed digital interface which has the capability to support standard, enhanced, or highdefinition video plus standard to multichannel surround-sound audio on a single digital connection. HDMI features include uncompressed digital video, a bandwidth of up to 5 gigabytes per second and communication between the AV source and AV devices such as DTVs.

ISO 9660 format

International standard for the volume and file structure of CD-ROM discs.

JPEG

A file format used for still images, such as photographs and illustrations. JPEG files are identified by the file extension “.jpg” or “.JPG”. Most digital cameras use this format.

MP3

MP3 (MPEG1 audio layer 3) is a compressed audio file format. Files are recognized by their file extension “.mp3” or “.MP3”.

MPEG audio

An audio format used on Video CDs and some DVD discs. This unit can convert MPEG audio to PCM format for wider compatibility with digital recorders and AV amplifiers. See also “PCM (Pulse Code Modulation)”.

MPEG video

The video format used for Video CDs and DVDs. Video CD uses the older MPEG-1 standard, while DVD uses the newer and much better quality MPEG-2 standard.

PBC (PlayBack Control) (Video CD only)

A system of navigating a Video CD through on-screen menus recorded onto the disc. Especially good for discs that you would normally not watch from beginning to end all at once—karaoke discs, for example.

PCM (Pulse Code Modulation)

The most common system of encoding digital audio, found on CDs and DAT. Excellent quality, but requires a lot of data compared to formats such as Dolby Digital and MPEG audio. For compatibility with digital audio recorders (CD, MD and DAT) and AV amplifiers with digital inputs, this unit can convert Dolby Digital, DTS and MPEG audio to PCM. See also “Digital audio”.

Progressive scan video

All the lines that make up a video picture are updated in one pass (compared to interlace which takes two passes to update the whole picture).

Regions (DVD-Video only)

These associate discs and players with particular areas of the world. This unit will only play discs that have compatible region codes. You can find the region code of your unit by looking on the rear panel. Some discs are compatible with more than one region (or all regions).

Sampling frequency

The rate at which sound is measured to be turned into digital audio data. The higher the rate, the better the sound quality, but the more digital information is generated. Standard CD audio has a sampling frequency of 44.1kHz, which means 44,100 samples (measurements) per second. See also “Digital audio”.

WMA

WMA is short for Windows Media Audio and refers to an audio compression technology developed by Microsoft Corporation. WMA data can be encoded by using Windows Media Player version 8 or Windows Media Player for Windows XP.

Troubleshooting

If you have any trouble using the DVD player, look for a solution in this section. If you can't resolve the issue yourself, contact your Onkyo dealer.

Symptom	Cause	Correction
No power.	The power cord is disconnected.	Plug the power cord into the wall outlet securely.
The power is on, but the unit does not work.	No disc is inserted.	Insert a disc.
No picture.	The TV is not set to receive the signal from the unit.	Select the appropriate video input mode on the TV.
	The video cable is not connected securely.	Connect the video cable securely.
	The TV system (PAL/NTSC) setting doesn't match.	Set the TV system to the appropriate TV system (page 20).
No sound.	The equipment connected with the audio cable is not set to receive the signal from the unit.	Select the correct input mode of the audio amplifier.
	The AUDIO options are set to the wrong position.	Set the AUDIO settings to the correct position.
	The DVD player is connected to the DVI jack on your TV or AV receiver.	You won't hear any sound from the HDMI OUT if your TV or AV receiver only supports DVI.
The unit does not start playback.	An unplayable disc is inserted.	Insert a playable disc. (Check the disc type and regional code.)
	The rating level is set.	Change the rating level.
The picture distorts occasionally?	The disc is dirty.	Remove the disc and clean it (page 9).
	You're using the Fast Forward or Fast Reverse function.	A little picture distortion may occur when using these functions. This is normal.
Picture instability or noise?	The DVD player is connected to your TV via a VCR or other video equipment whose copy protection system is affecting the picture.	Connect the DVD player directly to your TV (page 16).
Can't start playback?	No disc loaded.	Load a disc.
	The disc is incompatible.	Load only compatible discs (page 8).
	The disc is upside down.	Load the disc the correct way up (page 24).
	The disc is not centered in the disc tray.	Place the disc in the center of the disc tray.
	The disc is dirty.	Remove the disc and clean it (page 9).
	The disc supports parental lock and the Parental Lock function is on.	Turn off the Lock function (page 22).
Can't play MP3 and JPEG discs?	The disc is not ISO 9660 Level 2 format.	Use only ISO 9660 Level 2 format discs.
	The disc has not been finalized.	Finalize the disc.
Can't select MP3 files?	MP3 files without a ".mp3" or ".MP3" filename extension are not recognized.	Use the correct filename extension.
	The MP3 disc is a multisession disc.	Only files in the first session of a multi-session disc can be played.

Troubleshooting—Continued

Symptom	Cause	Correction
Can't play WMA files?	WMA files without a “.wma” or “.WMA” filename extension are not recognized.	Use the correct filename extension.
	The WMA file's copyright option is on.	Don't use the copyright option.
Can't view JPEG files?	JPEG files without a “.jpg” or “.JPG” or “.JPEG” filename extension are not recognized.	Use the correct filename extension.
	The JPEG file is too big.	Use JPEG files that are less than 5 megabytes.
Can't play a DivX file?	The file is not encoded correctly.	Make sure the DivX file was encoded with DivX Version 5, 4, or 3 Home Theater mode.
DivX plays but there's no sound?	The DVD player may not support the audio format.	Try re-encoding the file with a supported audio format.
Buttons on the DVD player and remote controller don't work?	Power supply voltage fluctuations and other anomalies, such as static electricity, can interfere with normal operation.	Turn off the DVD player, wait five seconds, then turn it on again. If that doesn't resolve the issue, disconnect the power cord from the wall outlet, wait ten seconds, reconnect it, then try again.
	The remote control does not work properly.	<p>The remote control is not pointed at the remote sensor on the unit.</p> <p>The remote control is too far from the unit.</p> <p>You're too far away from the DVD player.</p> <p>A strong light source is interfering with the DVD player's remote sensor.</p> <p>If the DVD player is installed in a cabinet with colored glass doors, the remote controller may not work reliably when the doors are closed.</p>
	Point the remote control at the remote sensor of the unit.	Operate the remote control closer to the unit.
	Use the remote controller closer to the DVD player (page 10). The remote controller has a range of approximately 16 ft. (5 meters).	Make sure that the DVD player is not subjected to direct sunshine or inverter-type fluorescent lights. Relocate if necessary.
	Open the doors, or use a cabinet without colored glass.	

The DVD player contains a microcomputer for signal processing and control functions. In very rare situations, severe interference, noise from an external source, or static electricity may cause it to lockup. In the unlikely event that this happens, unplug the power cord from the wall outlet, wait at least 5 seconds, and then plug it back in again.

Onkyo is not responsible for damages (such as CD rental fees) due to unsuccessful recordings caused by this unit's malfunction. Before you record important data, make sure that the material will be recorded correctly.

Specifications

Signal System		North American Model: NTSC European and Oceanian models: PAL/NTSC
Composite Video Output/Impedance		1.0 V (p-p)/75 Ω negative sync, RCA/phono
S-Video Output/Impedance (not European model)		Y: 1.0 V (p-p)/75 Ω negative sync, 4-pin mini DIN C: 0.286 V (p-p)/75 Ω
Component Video Output/Impedance		Y: 1.0 V (p-p)/75 Ω PB/PR: 0.7 V (p-p)/75 Ω RCA/phono
HDMI Out		19 pin connector
AV Connector (European model only)		1.0 V (p-p)/75 Ω, SCART
Frequency response	DVD Linear Sound	20 Hz–44 kHz (96 kHz) 20 Hz–22 kHz (48 kHz)
	Audio CD	20 Hz–20 kHz (44.1 kHz)
S/N Ratio		105 dB
Audio Dynamic Range		100 dB
THD (Total Harmonic Distortion)		0.03 % (1 kHz)
Wow and Flutter		Below threshold of measurability
Audio Output (Digital Optical)		–22.5 dBm (Oceanian model only)
Audio Output/Impedance (Digital Coaxial)		0.5 V (p-p)/75 Ω
Audio Output/Impedance (Analog)		2.0 V (rms)/550 Ω

■ General

Power Supply	AC 120 V, 60 Hz (North American model) AC 110–240 V, 50 Hz/60 Hz (Oceanian model) AC 220–240 V, 50 Hz/60 Hz (European model)
Power Consumption	9 W
Stand-by Power Consumption	0.9 W (North American model) 0.9 W (European and Oceanian models)
Dimensions (W x H x D)	435 W x 58.5 H x 25 D mm, 17-1/8" × 2-5/16" × 1"
Weight	1.7 kg, 3.7 lbs
Operation Condition Temperature	+5° C to +40° C
Disc Compatibility	DVD-video, DVD-R/RW, DVD+R/RW, Audio CD, CD-R/RW, Video CD, MP3, WMA, JPEG, DivX Video Disc that have not been property finalized may only be partially playable or not playable at all

Specifications and features subject to change without notice.

Memo

ONKYO CORPORATION

Sales & Product Planning Div. : 2-1, Nisshin-cho, Neyagawa-shi, OSAKA 572-8540, JAPAN
Tel: 072-831-8023 Fax: 072-831-8163

ONKYO U.S.A. CORPORATION

18 Park Way, Upper Saddle River, N.J. 07458, U.S.A.
Tel: 201-785-2600 Fax: 201-785-2650 <http://www.us.onkyo.com/>

ONKYO EUROPE ELECTRONICS GmbH

Liegnitzerstrasse 6, 82194 Groebenzell, GERMANY
Tel: +49-8142-4401-0 Fax: +49-8142-4401-555 <http://www.eu.onkyo.com/>

ONKYO EUROPE UK Office

Suite 1, Gregories Court, Gregories Road, Beaconsfield, Buckinghamshire, HP9 1HQ
UNITED KINGDOM Tel: +44-(0)1494-681515 Fax: +44(0)-1494-680452

ONKYO CHINA LIMITED

Unit 1&12, 9/F, Ever Gain Plaza Tower 1, 88, Container Port Road, Kwai Chung,
N.T., HONG KONG Tel: 852-2429-3118 Fax: 852-2428-9039
<http://www.ch.onkyo.com/>



I0804-1

SN 29344852

(C) Copyright 2008 ONKYO CORPORATION Japan. All rights reserved.



* 2 9 3 4 4 8 5 2 *